



# ***PF2200 - FD***

*PRODUCT MANUAL*

**Warning:**

All PF2200 installations must follow the installation, commissioning, operation, and maintenance procedures outlined in this manual. Failure to comply with the instructions and warnings in this manual may result in death, serious injury, electrocution, property damage, product damage, and/or government fines. All PF2200 installations must be performed in accordance with local electrical code(s) by a capable electrician, and must be field inspected by the Authority Having Jurisdiction to ensure compliance with local electrical and gas codes.

Explosion Hazard. Do not connect or disconnect when energized.

Do not service or open enclosure unless power has been switched off or the area is known to be non-hazardous.

Do not remove or replace fuse when system is powered. Replacement fuses must be ceramic and of correct rating (10A, 150V<sub>DC</sub>, Slow Blow). Contact Profire for fuse replacements.

All safety functions must be end-to-end proven following commissioning of the system.

Substitution of components may impair suitability for Class I, Division 2.

**Avertissement:**

Toutes les installations PF2200 doivent être conformes aux procédures d'installation, de mise en service, d'utilisation et d'entretien décrites dans ce manuel. Le non-respect des instructions et des avertissements de ce manuel peut entraîner la mort, des blessures graves, l'électrocution, des dommages matériels, des dommages au produit et/ou des amendes gouvernementales. Toutes les installations PF2200 doivent être effectuées conformément au(x) code(s) électrique(s) local(aux) par un électricien compétent, et doivent être inspectées sur place par l'autorité compétente afin de garantir la conformité aux codes locaux de l'électricité et du gaz.

Risque d'explosion. Ne pas brancher ni débrancher sous tension.

Ne pas réparer ou ouvrir le boîtier si l'instrument est sous tension ou que la zone est reconnue pour être non-dangereuse.

Ne pas retirer ou remplacer le fusible lorsque le système est sous tension. Les fusibles de remplacement doivent être en céramique et de valeur nominale correcte (10A, 150VDC, slow blow). Contactez Profire pour le remplacement des fusibles.

Toutes les fonctions de sécurité doivent être éprouvées de bout en bout après la mise en service du système.

La substitution de composants peut rendre ce matériel inacceptable pour les emplacements de Classe I, Division 2.

# CONTENTS

<b>1</b>	<b>SCOPE</b> .....	<b>4</b>	<b>6</b>	<b>INSTALLATION</b> .....	<b>61</b>
<b>2</b>	<b>APPROVALS AND RATINGS</b> .....	<b>4</b>	6.1	Mounting Considerations .....	61
2.1	Product Declarations.....	5	6.2	Connection Diagrams.....	62
2.2	Electrical And Mechanical Ratings .....	6	<b>7</b>	<b>SYSTEM CONFIGURATION</b> .....	<b>69</b>
<b>3</b>	<b>USER INTERFACE CARD</b> .....	<b>9</b>	7.1	Temperatures .....	69
3.1	Keypad.....	9	7.2	Inputs .....	71
3.2	Controller Interface.....	10	7.3	Process Control.....	75
3.3	Status LED.....	15	7.4	Outputs.....	77
3.4	Modbus Communication.....	16	7.5	Setup.....	79
3.5	USB Port .....	17	<b>8</b>	<b>MAINTENANCE</b> .....	<b>81</b>
<b>4</b>	<b>BMS CARD</b> .....	<b>18</b>	8.1	Transportation and Storage Conditions.....	81
4.1	Pressure Input .....	19	8.2	Repair and Replacement.....	81
4.2	High Pressure Input.....	20	8.3	Decommissioning.....	81
4.3	Proof of Position Input .....	21	8.4	Useful Life .....	81
4.4	Proof of Closure Input .....	22	8.5	Manufacturer Notification.....	81
4.5	Temperature Control Valve Output .....	23	<b>9</b>	<b>TROUBLESHOOTING</b> .....	<b>82</b>
4.6	Pilot 1 Valve Solenoid Output .....	24	<b>10</b>	<b>ALERT CODES &amp; RESPONSE TIMES</b> .....	<b>83</b>
4.7	Pilot 2 Valve Solenoid Output .....	25	10.1	Alarms .....	83
4.8	Main Valve Solenoid Outputs.....	26	10.2	Waits.....	88
4.9	Fan Output .....	27	10.3	Warnings.....	89
4.10	Status Contact .....	28	10.4	Main Permissives .....	90
4.11	Controller Power Input.....	29	<b>11</b>	<b>GLOSSARY</b> .....	<b>91</b>
4.12	Emergency Shutdown Input.....	30	<b>12</b>	<b>ACRONYMS</b> .....	<b>92</b>
4.13	Remote Start Input.....	31	<b>13</b>	<b>DOCUMENT REVISION HISTORY</b> .....	<b>93</b>
4.14	Auxiliary Outputs.....	32			
4.15	Level/Flow Input.....	33			
4.16	Proof of Airflow Input .....	34			
4.17	Auxiliary Inputs.....	34			
4.18	UV Flame Detection Inputs .....	37			
4.19	Pilot Ignition I/O .....	38			
4.20	External Ignition Switch Input .....	39			
4.21	Bath Temperature Input .....	40			
4.22	Outlet Temperature Input.....	41			
4.23	Stack Temperature Input .....	42			
<b>5</b>	<b>OPERATING SEQUENCE</b> .....	<b>43</b>			
5.1	Power On State .....	44			
5.2	Lockout State.....	45			
5.3	Alarm State.....	48			
5.4	Ready State .....	49			
5.5	Waiting State.....	50			
5.6	Startup Checks State .....	51			
5.7	Proven Pre-Purge State .....	52			
5.8	Ignition State .....	54			
5.9	Pilot State .....	55			
5.10	Main Light Off State .....	57			
5.11	Process Control State .....	59			
5.12	Main Turndown State.....	60			

# 1 SCOPE

The PF2200-FD Burner Management System is an automated safety controller designed to monitor and control industrial heating processes that utilize single burner forced draft appliances. It provides safe burner ignition, ionization or UV flame detection, temperature control, position proving and peripheral input device monitoring. The user interface provides real-time system status and state information as well as detailed alert annunciation, advanced diagnostics and data logging. The system has been optimized for power consumption to be utilized in a variety of applications and can be monitored remotely.

This document provides detailed descriptions of the PF2200-FD inputs, outputs and operating sequence as well as installation, maintenance and commissioning instructions. This document is applicable for the following hardware and firmware versions:

BMS Card Hardware Version	UI Card Hardware Version	PF2200-FD Firmware Version
v2.3.x	v3.2.x	FD 2.1.2

Contact Profire if you require a previous version of the PF2200-FD Product Manual.

The card hardware versions and current system firmware can be found on the Information screen (System > Firmware > Info) of the User Interface, where the BOM Version corresponds to the card hardware and Bundle Version corresponds to the system firmware. Additionally, the card hardware version is printed on the last line of the QR code label affixed to each card.

Note that the BMS firmware version and the UI firmware version must match in order for the system to operate correctly. Mismatched firmware is not supported.

# 2 APPROVALS AND RATINGS

The PF2200-FD is approved for use in a 1oo1 deployment configuration and is certified to the following standards:



SIL 2 Capable  
IEC 61508: 2010 Parts 1-7



Electrical Burner Control System  
UL 60730-2-5/ ANSI Z21.20-2014 • CSA C22.2 No. 60730-2-5  
Class I Div 2 Group A, B, C & D, T4A (Class I, Zone 2, Group IIC – US Only)  
UL 121201 • CSA-C22.2 No. 213



Type 4X  
CSA C22.2 No. 94.1:15 • CSA C22.2 No. 94.2:15, Ed. 2  
UL 50:15, Ed. 13 • UL 50E:15, Ed. 2  
IP66  
CSA-C22.2 No. 60529:16

## 2.1 PRODUCT DECLARATIONS

System Parameter	Value
Maximum Flame Detector Response Time	50ms
Minimum Flame Detector Self-Checking Rate	1Hz
Maximum Ionization Flame Failure Lock-Out Time	4s
Maximum UV Flame Failure Lock-Out Time	1s
Maximum Flame-Failure Reignition Time	120s <sup>Note 1</sup>
Maximum Ignition Time	11s
Maximum Pilot-Flame Establishing Period	10s
Maximum Main-Flame Establishing Period	10s
Maximum Post-Ignition Time	2.5s
Maximum Pre-Ignition Time	1s
Minimum Pre-Purge Time	10s
Minimum Inter-Purge Time	10s
Minimum Post-Purge Time	10s
Minimum Recycle Time	10s <sup>Note 2</sup>
Maximum Start-up Lock-Out Time	10s <sup>Note 3</sup>
Maximum Number of Start-Up Retries	3
Minimum Waiting Time	10s
Pollution Degree	1 <sup>Note 4</sup>
Signal for Absence/Presence of Flame	-2.54V <sup>Note 5</sup>
High Voltage Spark Gap Range	2 – 8mm
Types of Action	Type 2: Electronic Disconnection, Non-volatile Lockout, Permanent Operation
Types of Burners	Full Rate Start and Low Rate Start
Type of Control	Incorporated Control
Types of Ignition	Interrupted
Types of Pilot	Continuous, Intermittent and Interrupted

<sup>1</sup> Flame-failure Reignition Time is only utilized when Reignition mode is enabled, both Pilots have enabled flame detection and when the other flame is continuously proven.

<sup>2</sup> Automatic Recycle is only permitted upon loss of a proven flame when configured **Relight Attempts** settings is not set to **0**.

<sup>3</sup> Since recycling is allowed, this time is from fuel flow energizing on start-up to fuel flow de-energize due to no flame presence.

<sup>4</sup> Pollution degree when installed in enclosure with a rating of IP54 or equivalent

<sup>5</sup> Flame signal is the amount that the AC signal being applied to the flame rod is rectified (i.e. the DC offset to the AC waveform)

## 2.2 ELECTRICAL AND MECHANICAL RATINGS

### 2.2.1 PRODUCT RATINGS

Type	Rating
Temperature - Operating	-40°C to 55°C (-40°F to 131°F)
Temperature - Storage	-40°C to 55°C (-40°F to 131°F)
Voltage Range - 12V Mode	10.2 V <sub>DC</sub> to 16.2 V <sub>DC</sub>
Voltage Range - 24V Mode	20.4 V <sub>DC</sub> to 32.4 V <sub>DC</sub>
Power Consumption - 12V Mode	Running with USB installed: 1.1 W, No USB: 0.7 W
Power Consumption - 24V Mode	Running with USB installed: 1.3 W, No USB: 0.9 W
Humidity - Product	0% to 100% Condensing
Humidity - BMS and UI Card	0% to 90% Non-condensing
Vibration - Tested	3g swept from 10Hz to 150Hz, 10 consecutive sweeps, 3-axis
Enclosure	304 Stainless Steel, Type 4X, IP66
Enclosure Dimensions	335mm x 251mm x 145mm (13.2" x 9.9" x 5.7")
Enclosure Weight	7.26 kg / 16 lbs.

A #2 Phillips screwdriver is required to open and close the enclosure.

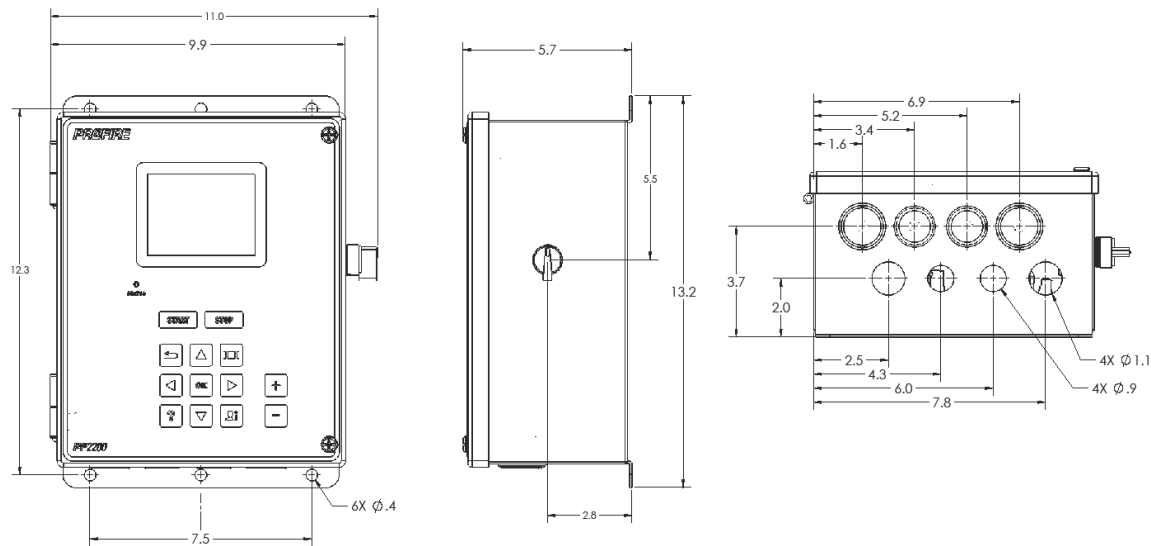

### 2.2.2 USER INTERFACE CARD ELECTRICAL RATINGS

Terminal	Input/ Output	Rating	AWG		Torque (Nm)		
			Min	Max	Min	Max	
MODBUS	1 A	RS-485, -7V – 7V Common Mode Range with reference to terminal 3 (-)	30	14	0.22	0.25	
	2 B						
	3 -						
PFN	4 +	O	30	14	0.22	0.25	
	5 PFN A	I/O					
	6 PFN B	I/O					
	7 -	O					
USB	- USB	I/O	5V <sub>DC</sub> , 200mA max	-	-	-	-
KEYPAD	- KEYPAD	I	3V <sub>DC</sub> , 4.75kΩ source impedance	-	-	-	-

**2.2.3 BMS CARD ELECTRICAL RATINGS**

Name	Safety Rated	Terminal	Input/ Output	Rating	AWG <sup>4</sup>		Torque (Nm)	
					Min	Max	Min	Max
USER INTERFACE	NO	1 +	O					
		2 PFN A	I/O	Power Out: 7-35V <sub>DC</sub> , 500mA Max	30	14	0.22	0.25
		3 PFN B	I/O	PFN: -7V – 7V Common Mode Range				
		4 -	O					
PRESS. COMM	YES	5 PWR	O	12V Mode: 12V <sub>DC</sub> , 24V Mode: 13.5V <sub>DC</sub> , 30mA Max				
PRESS. HIGH	YES	6 SIG IN	I	30V <sub>DC</sub> Max <sup>2 3</sup>	30	12	0.5	0.6
		7 PWR	O	12V Mode: 12V <sub>DC</sub> , 24V Mode: 13.5V <sub>DC</sub> , 30mA Max				
PoP	YES	8 SIG IN	I	30V <sub>DC</sub> Max <sup>2</sup>	30	12	0.5	0.6
		9 PWR	O	12V Mode: 12V <sub>DC</sub> , 24V Mode: 13.5V <sub>DC</sub> , 30mA Max				
PoC	YES	10 SIG IN	I	30V <sub>DC</sub> Max <sup>2 3</sup>	30	12	0.5	0.6
		11 PWR	O	12V Mode: 12V <sub>DC</sub> , 24V Mode: 13.5V <sub>DC</sub> , 30mA Max				
TCV	NO	12 SIG IN	I	30V <sub>DC</sub> Max <sup>2</sup>	30	12	0.5	0.6
		13 OUT	O	20mA Max Output, Expected Load: < 350Ω				
PILOT 1	YES	14 GND		±0.1 mA Accuracy	30	12	0.5	0.6
		15 +	O					
PILOT 2	YES	16 -	O		30	12	0.5	0.6
		17 +	O	12V <sub>DC</sub> /24V <sub>DC</sub>				
SSV	YES	18 -	O	5A Max	30	12	0.5	0.6
		19 +	O	Pulsed Output with configurable PWM				
		20 -	O	Expected Load: Inductive/Resistive				
		21 +	O					
FAN	NO	22 -	O		30	12	0.5	0.6
		23 +	O	12V <sub>DC</sub> /24V <sub>DC</sub>				
RUN STATUS	NO	24 -	O	5A Max	30	12	0.5	0.6
		25 A	-	120V, 170Vpk Max				
		26 NOT USED		1500V Max impulse				
EGND	NO	27 B	-	1A <sub>RMS</sub> Max	30	12	0.5	0.6
		28 EGND		Earth ground terminal				
POWER IN	NO	29 -			30	12	0.5	0.6
		30 -	I	12V <sub>DC</sub> /24V <sub>DC</sub>				
		31 +	I	10A Max				
ESD	YES	32 +			30	12	0.5	0.6
		33 PWR	O	12V Mode: 12V <sub>DC</sub> , 24V Mode: 13.5V <sub>DC</sub> , 30mA Max				
START	YES	34 SIG IN	I	30V <sub>DC</sub> Max <sup>2</sup>	30	12	0.5	0.6
		35 PWR	O	12V Mode: 12V <sub>DC</sub> , 24V Mode: 13.5V <sub>DC</sub> , 30mA Max				
AUX OUT 1	NO	36 SIG IN	I	30V <sub>DC</sub> Max <sup>2</sup>	30	12	0.5	0.6
		37 OUT	O	20mA Max Output				
AUX OUT 2	NO	38 GND		Expected Load: < 350Ω	30	12	0.5	0.6
		39 OUT	O	±0.1 mA Accuracy				
LEVEL/ FLOW	YES	40 GND			30	12	0.5	0.6
		41 PWR	O	12V Mode: 12V <sub>DC</sub> , 24V Mode: 13.5V <sub>DC</sub> , 30mA Max				
		42 SIG IN	I	30V <sub>DC</sub> Max <sup>2 3</sup>				

Name	Safety Rated	Terminal	Input/ Output	Rating	AWG <sup>4</sup>		Torque (Nm)	
					Min	Max	Min	Max
PROOF OF AIR	YES	43 PWR	O	12V Mode: 12V <sub>DC</sub> , 24V Mode: 13.5V <sub>DC</sub> , 30mA Max	30	12	0.5	0.6
		44 SIG IN	I	30V <sub>DC</sub> Max <sup>3</sup>				
AUX IN 1	YES	45 PWR	O	12V Mode: 12V <sub>DC</sub> , 24V Mode: 13.5V <sub>DC</sub> , 30mA Max	30	12	0.5	0.6
		46 SIG IN	I	30V <sub>DC</sub> Max <sup>2,3</sup>				
AUX IN 2	YES	47 PWR	O	12V Mode: 12V <sub>DC</sub> , 24V Mode: 13.5V <sub>DC</sub> , 30mA Max	30	12	0.5	0.6
		48 SIG IN	I	30V <sub>DC</sub> Max <sup>2,3</sup>				
UV SCANNER	YES	49 PWR	O	12V Mode: 12V <sub>DC</sub> , 24V Mode: 13.5V <sub>DC</sub> , 30mA Max	30	12	0.5	0.6
		50 FAULT	I	30V <sub>DC</sub> Max <sup>2</sup>				
		51 FLAME	I	30V <sub>DC</sub> Max <sup>2</sup>				
PILOT 1 ION	YES	53 +	I/O	Intermittent 80-130 V <sub>RMS</sub> Output	30	12	0.5	0.6
		54 -	I/O					
PILOT 1 COIL	YES	55 -	O	12V <sub>DC</sub> /24V <sub>DC</sub> Pulsed Output	30	12	0.5	0.6
		56 +	O	Expected Load: Inductive				
PILOT 2 ION	YES	57 +	I/O	Intermittent 80-130 V <sub>RMS</sub> Output	30	12	0.5	0.6
		58 -	I/O					
PILOT 2 COIL	YES	59 -	O	12V <sub>DC</sub> /24V <sub>DC</sub> Pulsed Output	30	12	0.5	0.6
		60 +	O	Expected Load: Inductive				
BATH	YES <sup>1</sup>	61 +	I	Thermocouple Mode: Type K Grounded or Ungrounded -100 °C to 1350 °C ±2 °C Accuracy	30	12	0.22	0.25
		62 -	I					
		63 R	I					
		64 +	I					
		65 -	I					
OUTLET	NO	66 R	I	RTD Mode: PT-100 RTD -100 °C to 850 °C ±0.5 °C Accuracy	30	12	0.22	0.25
		67 +	I					
		68 -	I					
STACK	NO	69 R	I		30	12	0.22	0.25
		70 +	I					
SWITCH <sup>5</sup>	YES	71 -	I	3.3V <sub>DC</sub> max	30	12	0.22	0.25
		- RUN	I					
		- IGN	I					
		- PWR	O	3.3V <sub>DC</sub> , 1kΩ source impedance				

<sup>1</sup> The Bath Temperature Input is safety rated ONLY if the input is configured as a Dual. If configured as a Single element the Bath temperature input is NOT safety rated.

<sup>2</sup> A digital input with an input current of 1.25mA or greater will be seen by the system as an energized input, while a digital input with an input current of 500µA or less will be seen by the system as a de-energized input.

<sup>3</sup> Input accuracy when configured in 4-20mA mode: ±0.1 mA

<sup>4</sup> All wire sizes listed indicate the size restrictions of the BMS connector only. All wires must be adequately sized for their respective current requirements in accordance with local electrical codes.









<sup>5</sup> Ignition Switch contacts must (1) be connected to a pre-wired, Profire-supplied PF2200 ignition switch (Part No. PFA-004260) or (2) have RUN and PWR terminals connected with a wire jumper.



## 3 USER INTERFACE CARD

The User Interface Card allows interaction with the system through the use of the keypad, display, Modbus port, and USB port. The card interacts with the BMS card through a proprietary communication protocol called PFN, which utilizes the RS-485 physical transport layer. PFN and power to the User Interface are factory wired to the BMS card through a wiring harness.

### 3.1 KEYPAD

Button	Functions
	Start the system from Ready state Reignite when one pilot is lost while running
	Stop the system <sup>1</sup>
	Return to previous screen from an on-screen menu
	Cycle through Status, Settings, and System screens
	Display keypad functionality help screen
	Switch to Commissioner Mode to see all available settings Switch to Operator Mode to see only essential settings and setpoints
	Navigate Menus and highlight items
	Select highlighted item Open settings adjustment dialog when highlighting numeric settings
	Change Status screen display mode Make incremental changes to numeric settings Scroll Event Log by full page

<sup>1</sup> The keypad is intended to aid in commissioning and system navigation, and it must not be incorporated into any safety function. If user shut-down is a required safety function, then the BMS Card ESD input or External Ignition Switch must be used.

Use the Keypad Diagnostic Tool (System > Diagnostics > Keypad) to check the functionality of each button individually.

### 3.2 CONTROLLER INTERFACE

The PF2200-FD controller consists of 3 main screens:

1. Status Screen – Always-on display that shows real-time system data including input device readings, controller state and alerts
2. Settings Screen – Screen containing all the configuration settings required to set up the system
3. System Screen – Screen containing tools for data logging and settings backup as well as a suite of diagnostic information for troubleshooting

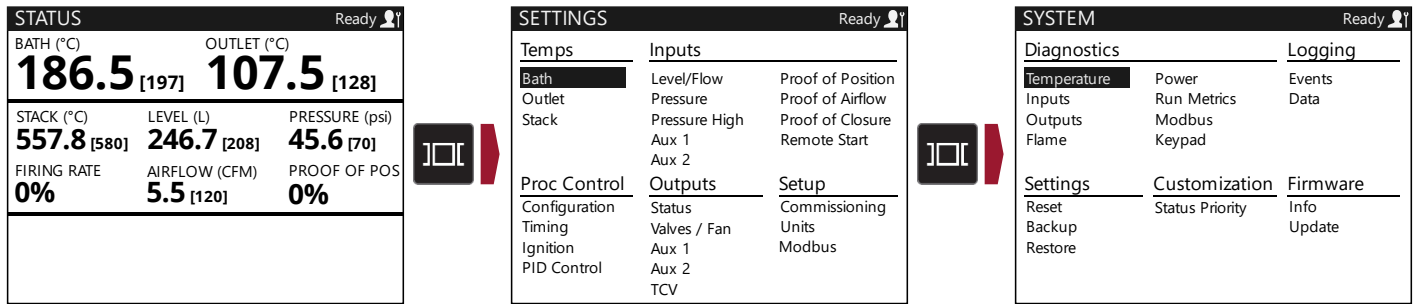

#### 3.2.1 STATUS SCREEN

The Status Screen displays the current controller state in the Status Bar at the top of the Status Screen. All current alarms, waits, warnings, and main permissives are displayed in the Alerts Pane at the bottom of the Status Screen. The main window of the Status Screen shows the current states/readings of the connected input devices.

The information displayed can be customized to show one, five, or eight status elements; use **+** and **-** to cycle between the one-item, five-item, and eight-item zoom levels. The order in which the status elements are displayed on each zoom level can be customized using the Status Priority Tool (System > Customization > Status Priority).

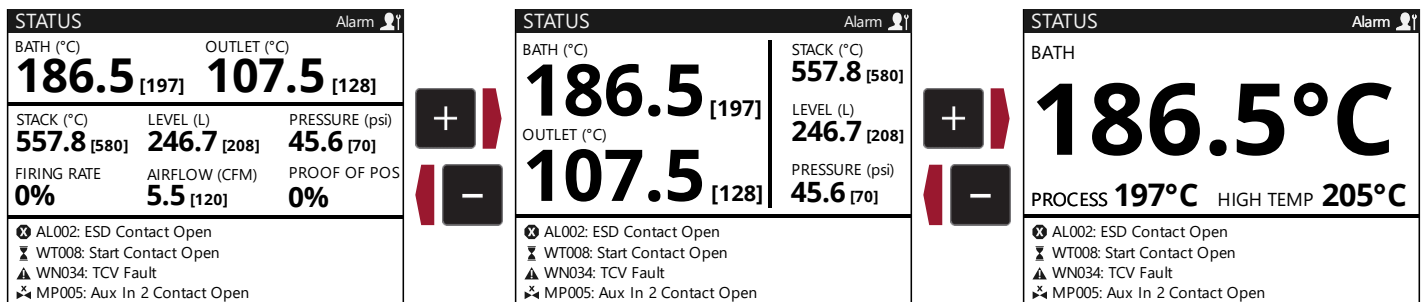

### 3.2.2 SETTINGS SCREEN

The Settings Screen contains sub-menus for all configuration settings required to commission a system. Use to select a menu and press to see a list of all related settings. By default, the Settings Screen is shown in Operator Mode, so a limited number of settings are displayed for quickly making changes after the system has been commissioned. Pressing will switch to Commissioning Mode and read-only access will be granted to all settings. Users must enter a valid password when prompted in order to modify settings.

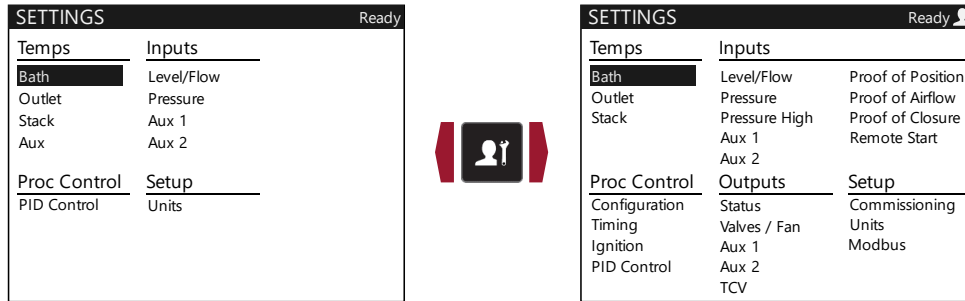

#### SETTINGS MODIFICATION

A valid password must be entered when prompted in order to adjust any setting. Each setting has a pre-determined security level based on its potential safety and reliability impact, and each security level has a separate password.

- L1 security level: settings that DO NOT impact the safety-integrity of the system BUT can impact the process operation.

If the **L1 Password Enable** setting is **Enabled**, L1 setting modification requires the L1 password. If the **L1 Password Enable** setting is **Disabled**, L1 settings can be modified with no password.

- L2 security level: settings that DO impact the safety-integrity of the system

For L1 and L2 passwords, please contact Profire customer service. Passwords will only be distributed to individuals that are capable of assessing the safety impact of the changes they intend to make.

After entering a valid password, the user is authenticated and can make changes to the associated settings. The authentication will timeout after 15 minutes regardless of activity. Any further attempt to adjust settings requires the user to re-authenticate.

DROP DOWN SETTINGS MODIFICATION

SETTINGS   Bath		Ready
Type	RTD	
Input	Dual	
Mode	Process Control	
High Temp Setpoint	90.0 °C	
Pilot Off Setpoint	85.0 °C	
Main Off Setpoint	85.0 °C	
Process Setpoint	80.0 °C	
Standby Setpoint	70.0 °C	
Low Temp Setpoint	0.0 °C	
Deadband	2.0 °C	

Accepted Change Method

Quick Settings Adjustment Method

NUMERIC SETTINGS MODIFICATION

SETTINGS   Bath		Ready
Type	RTD	
Input	Dual	
Mode	Process Control	
High Temp Setpoint	90.0 °C	
Pilot Off Setpoint	85.0 °C	
Main Off Setpoint	85.0 °C	
Process Setpoint	80.0 °C	
Standby Setpoint	70.0 °C	
Low Temp Setpoint	0.0 °C	
Deadband	2.0 °C	

Accepted Change Method

Quick Settings Adjustment Method

Settings changes made using the Quick Settings Adjustment methods take effect immediately when changed. Settings changes made using the Accepted Change method do not take effect until after the change has been accepted by the user. When using the accepted change method, pressing will discard a change that has not yet been accepted by the user.

### 3.2.3 SYSTEM SCREEN

The PF2200 Systems screen contains tools for system monitoring, troubleshooting, and customization. The diagnostics menus contain useful real-time troubleshooting information, the logging tools provide detailed event history and data logging functionality, the settings tools allow saving and loading of settings between controllers, and the status priority tool allows for customization of the information displayed on the Status screen.

#### DIAGNOSTICS

Menu Item	Description
Temperature Diagnostics	Displays real-time temperature readings of all temperature inputs and ambient temperature sensors.
Input Diagnostics	Displays real-time external switch position and voltage or current readings of all BMS inputs.
Output Diagnostics	Displays real-time TCv output position and power consumption readings for all solenoid outputs.
Flame Diagnostics	Displays real-time flame strength information, flame fails since last power cycle and allowable relights remaining.
Power Diagnostics	Displays real-time and average hourly power consumption readings.
Run Metrics	Displays system and valve run times since last power cycle and cumulative pilot and main light off failures since last power cycle.
Modbus Diagnostics	Displays Modbus transmission statistics, error counts and key troubleshooting information.
Keypad Diagnostics	Interactive tool for testing the functionality of each key on the keypad.

#### LOGGING

##### EVENT LOG

The Event Log screen displays a full history of system events for reference and troubleshooting. Events are continuously recorded to the USB storage device when inserted.

The event log displays all events that are stored on the USB storage device. If no USB is installed, the system only displays a limited number of past events and gets cleared upon power cycle. When the USB device is full, the oldest event will be deleted to make room for a new event to be logged.

Date	Time	Description
Sep 30	4:12:46	Shutdown: ESD Contact Open
Sep 30	4:12:46	Alarm 2: ESD Contact Open
Sep 13	15:06:35	Entered State: PID Control
Sep 13	15:01:35	Entered State: Main Delay
Sep 13	15:01:31	Entered State: Main Detect
Sep 13	15:01:27	Entered State: Main Light Off
Sep 13	15:00:57	Entered State: Req Light Off
Sep 13	15:00:57	Entered State: Pilot
Sep 13	15:00:50	Entered State: Ignition
Sep 13	15:00:20	Entered State: Req Pilot Pos
Sep 13	14:55:20	Entered State: Pre Purge

**Event Filters**

- Info
- Alarm
- Wait/Warning/Main Permissive
- Process Control
- Debug
- Shutdown
- Interface

Use the event log filter to view specific events on the system screen. All event types will still be logged to the USB storage device, regardless of the filters selected.

**DATA LOGGING**

The Data Logging tool logs input/output readings for up to 8 user selectable pieces of system information to the USB storage device. The data is logged in 15 second intervals and saved to the USB storage device regularly.

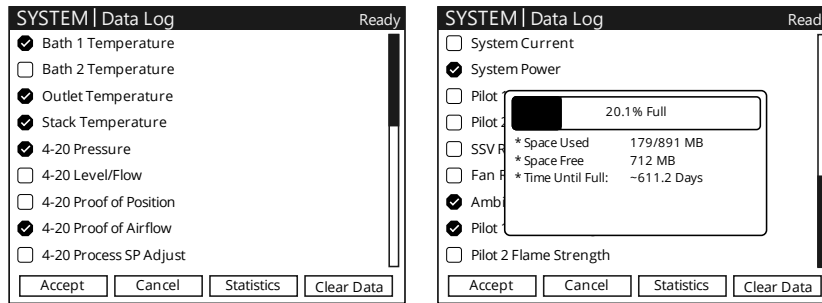

Use the Data Log Statistics window to see an estimate of how long the system will run before the USB storage device becomes full. Once full, the oldest data will be deleted and replaced with new data.

**SETTINGS**

Menu Item	Description
Reset	Resets all BMS settings to their default values.
Backup	Saves all current BMS settings to the USB storage device.
Restore	Tool to load BMS settings from the USB storage device.

Some settings may not be restored when loading a settings file from a system with a different version of firmware installed. The settings restore tool provides a list of all settings that were not restored. Ensure that all settings are correct after using the Settings Restore tool.

**STATUS PRIORITY**

The Status Priority tool allows configuration of the items displayed on the main Status screen. Use ▲ and ▼ to select a status element and + and - to move it up or down the priority list.

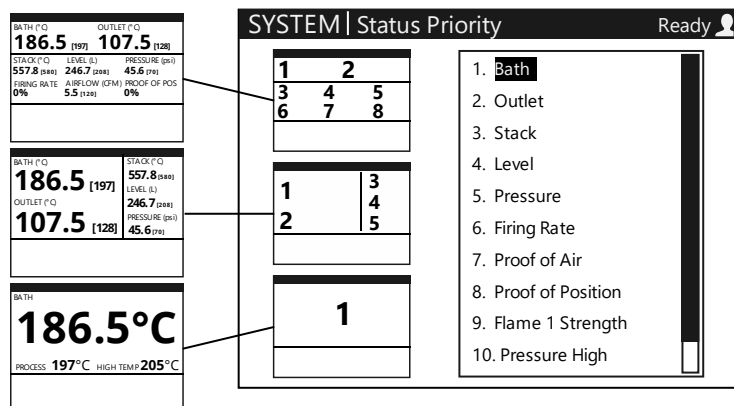

The images on the Status Priority screen represent the Status screen and show how the status elements will be displayed in the one, five, or eight element Status screen views.

FIRMWARE

INFORMATION

The Information screen shows displays useful firmware and hardware information associated with the BMS and UI cards.

SYSTEM   FW Info		Ready
BMS Bundle Version	FD 2.1.2	
BMS Hardware Model	2200-02	
BMS HW Product Variant	Forced Draft	
BMS FW Product Variant	Forced Draft	
BMS Firmware Version	v2.1.1	
BMS Bootloader Version	v1.1.1	
BMS BOM Version	v2.3.0	
BMS Region Code	North America	
BMS Serial Number	93000-0000-xxxx	
BMS Manufacture Date	YYYY-MM-DD	
BMS Test Date	YYYY-MM-DD	
BMS PFN Version	v2.1.1	

It is useful to have this system information on hand when contacting Profire for technical support.

UPDATE

The Firmware Update tool facilitates system software upgrades in the field. A USB drive containing an approved firmware bundle file can be used to update the system.

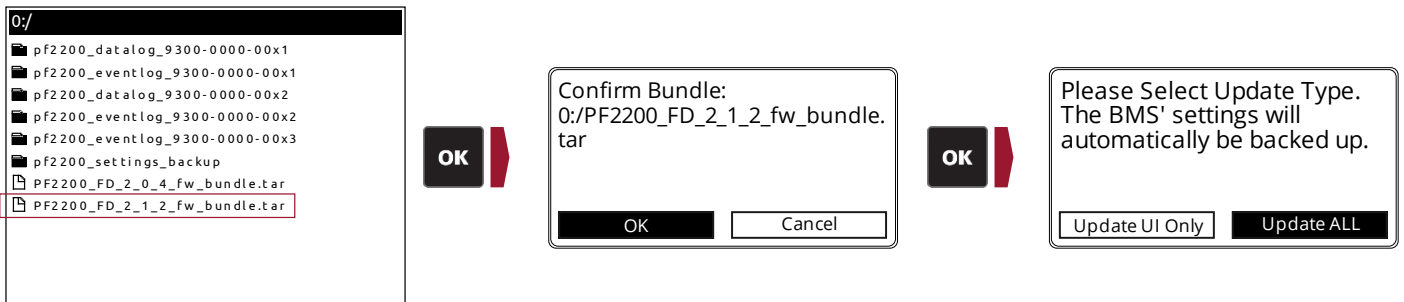

### 3.3 STATUS LED

The LED on the front of the PF2200-FD indicates the current operating state of the system.

#### 3.3.1 STATUS LED BEHAVIOR

System state	Condition	Behavior
Power On	Any	Cycles Green, Amber, Red
Alarm	Any	Slow flashing Red
Ready	Any	Solid Red
Lockout	Any	Fast flashing Red
Waiting	No Warning present	Slow flashing Green
	Warning present	Slow flashing Amber
Startup Checks		
Proven Pre-Purge	No Warning present	Solid Green
Ignition		
Pilot		
Main Light Off		
Process Control	Warning present	Solid Amber
Main Turndown		

### 3.4 MODBUS COMMUNICATION

Remote access to status information and non-safety critical settings is available via the Modbus terminals on the UI card. Refer to the PF2200-FD Modbus Configuration Guide for detailed programming information.

#### 3.4.1 INTENDED FIELD DEVICE CONNECTIONS

Field Device	Configuration Requirements	Connection Diagrams
Modbus Communication Module -Terminating resistor not required	<b>Settings &gt; Setup &gt; Modbus</b> Modbus RTU Communication: Enabled Modbus Termination: Disabled All other settings: As desired	<a href="#">Modbus Input Wiring</a>
Modbus Communication Module -Terminating resistor required	<b>Settings &gt; Setup &gt; Modbus</b> Modbus RTU Communication: Enabled Modbus Termination: Enabled All other settings: As desired	<a href="#">Modbus Input Wiring</a>
Not Used	<b>Settings &gt; Setup &gt; Modbus</b> Modbus RTU Communication: Disabled	N/A

Navigate to the Modbus Diagnostics Screen (System > Diagnostics > Modbus) for useful Modbus troubleshooting information.



## 3.5 USB PORT

The USB port of the User Interface card is used for data-logging as well as settings backup and restore functionality.

### 3.5.1 USB FUNCTIONS

Function	Configuration Requirements
Event logging to USB	<b>System &gt; Logging &gt; Events</b> No configuration required - Event log is automatically stored to USB when installed
Data logging to USB	<b>System &gt; Logging &gt; Data</b> Select up to 8 items to log
Saving current controller settings to USB	<b>System &gt; Settings &gt; Backup</b>
Loading saved controller settings from USB	<b>System &gt; Settings &gt; Restore</b> Select desired file to load

An approved USB storage device must be used; use of a non-approved USB storage device may compromise USB functionality. Each PF2200 is shipped with one approved USB storage device. Please contact Profire for replacements.

# 4 BMS CARD

The BMS card provides the necessary inputs and outputs to safely control a burner as well as additional inputs and outputs to reliably accommodate a variety of forced draft burner applications. The following section outlines the behavior and intended device connections for each BMS input and output and provides brief configuration instructions and links to the appropriate [Connection Diagrams](#).

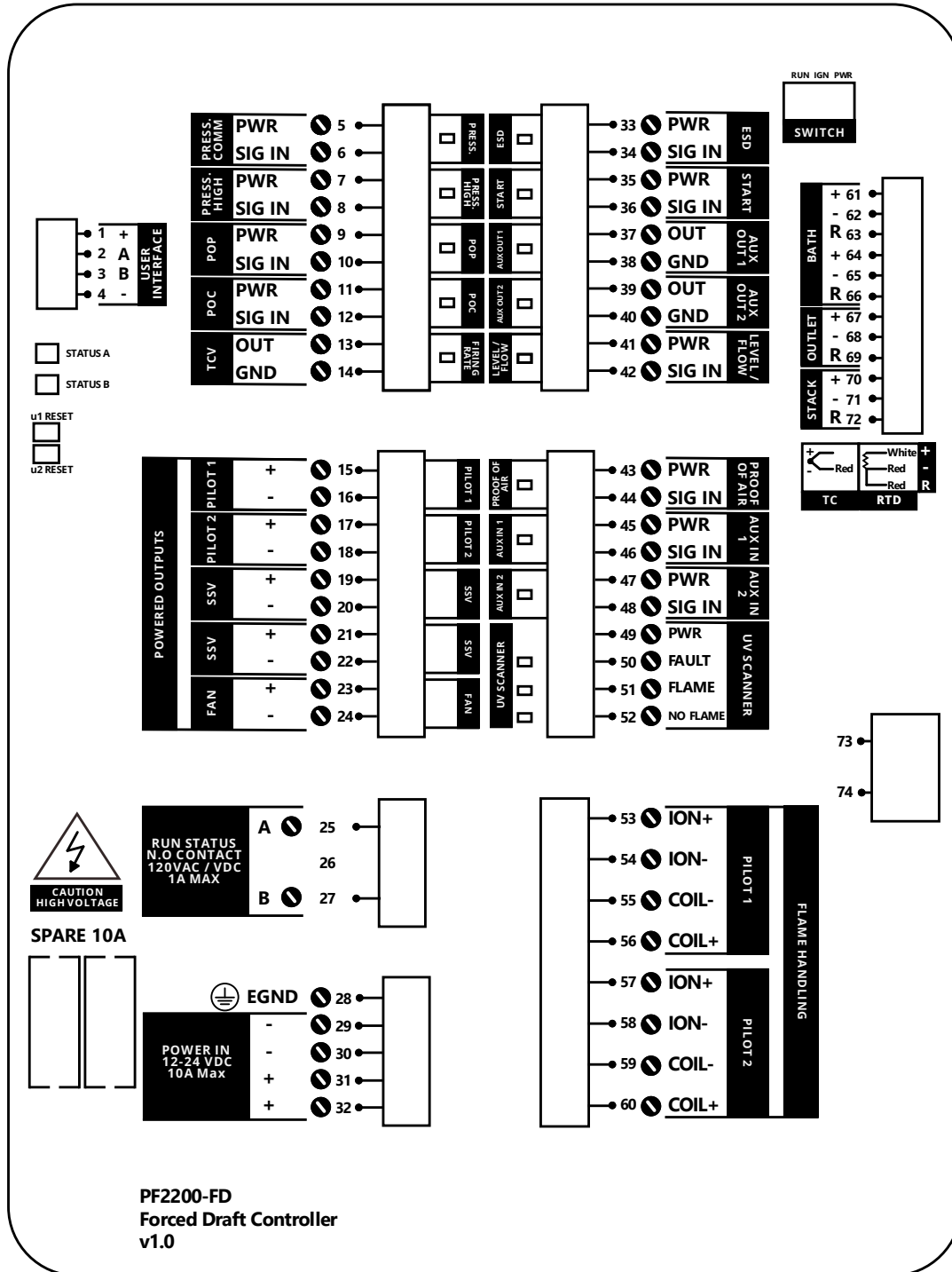

## 4.1 PRESSURE INPUT

### 4.1.1 DETAILS

Item	
Terminals	5 & 6
Name	PRESS COMM
Type	Configurable digital or 4-20mA input

### 4.1.2 INTENDED FIELD DEVICE CONNECTIONS

Field Device	Configuration Requirements	Connection Diagrams
Low-pressure switch	<b>Settings &gt; Inputs &gt; Pressure</b> Type: Digital Low Pressure Mode: As desired All other settings: Ignored <b>System &gt; Customization &gt; Status Priority</b> As desired	<a href="#">Digital Input – Dry Contact</a> <a href="#">Digital Input – Wet Contact</a>
4-20mA pressure transmitter	<b>Settings &gt; Inputs &gt; Pressure</b> Type: 4-20 Span Min/Max: transmitter Min/Max All other settings: As desired <b>Settings &gt; Setup &gt; Units</b> Pressure: As desired <b>System &gt; Customization &gt; Status Priority</b> As desired	<a href="#">Analog Input - Loop Powered 4-20mA Transmitter</a> <a href="#">Analog Input – Self Powered 4-20mA Transmitter</a>
Not Used	<b>Settings &gt; Inputs &gt; Pressure</b> Type: Disabled	N/A

The Pressure input must be connected to a low-pressure switch when configured as a digital input. The High Pressure Input (terminals 7 & 8) must be used to connect a high pressure switch.

### 4.1.3 SYSTEM BEHAVIOR

Configuration Details	Scenario				
	Pressure Input State	SSV Output State	State Transition if Running	Alerts Pane	
Type: Digital	Low Pressure Mode: Alarm	De-energized	Any	Lockout	Low Pressure Alarm
	Low Pressure Mode: Wait	De-energized	Any	Waiting <sup>1</sup>	Low Pressure Wait
	Low Pressure Mode: Warning	De-energized	Any	No effect	Low Pressure Warning
	Low Pressure Mode: Main Permissive	De-energized	Any	Pilot <sup>2</sup>	Low Pressure Main Permissive
	Any	Energized	Any	No effect	N/A
	Any	Out of Range	Any	Lockout	Pressure Range Alarm
Type: 4-20	Any	High Trip	De-energized	No effect	High Pressure Warning
	Any	High Trip	Energized	Lockout	High Pressure Alarm
	Low Pressure Mode: Alarm	Low Trip	Any	Lockout	Low Pressure Alarm
	Low Pressure Mode: Wait	Low Trip	Any	Waiting <sup>1</sup>	Low Pressure Wait
	Low Pressure Mode: Warning	Low Trip	Any	No effect	Low Pressure Warning
	Low Pressure Mode: Main Permissive	Low Trip	Any	Pilot <sup>2</sup>	Low Pressure Main Permissive

<sup>1</sup> System transitions to Waiting state via the Main Turndown state when coming from the Process Control state.

<sup>2</sup> No effect if running in a non-fuel state

A high-pressure event on the Pressure input will cause the burner to transition to the Lockout state only if it persists once the burner has entered a main fuel state. In any other state, the system will display a high pressure warning in the Alerts Pane and the burner will continue to run. This is true only when the **Pressure Type** setting is set to **4-20**. The state of the SSV Output is not considered when **Type** is set to **Digital**.

## 4.2 HIGH PRESSURE INPUT

### 4.2.1 DETAILS

Item	
Terminals	7 & 8
Name	PRESS HIGH
Type	Digital input

### 4.2.2 INTENDED FIELD DEVICE CONNECTIONS

Field Device	Configuration Requirements	Connection Diagrams
High pressure switch	<b>Settings &gt; Inputs &gt; Pressure High</b> Pressure High: Enabled <b>System &gt; Customization &gt; Status Priority</b> As desired	<a href="#">Digital Input – Dry Contact</a> <a href="#">Digital Input – Wet Contact</a>
Not Used	<b>Settings &gt; Inputs &gt; Pressure High</b> Pressure High: Disabled	N/A

### 4.2.3 SYSTEM BEHAVIOR

Configuration Details	Pressure High Input state	State Transition if Running	Alerts Pane
Pressure High: Enabled	De-energized	Lockout	High Pressure Alarm
	Energized	No effect	N/A
Pressure High: Disabled	Any	No effect	N/A

### 4.3 PROOF OF POSITION INPUT

#### 4.3.1 DETAILS

Item	
Terminals	9 & 10
Name	POP
Type	Configurable Digital or 4-20mA Input

#### 4.3.2 INTENDED FIELD DEVICE CONNECTIONS

Field Device	Configuration Requirements	Connection Diagrams
Temperature control valve with 4-20mA position output signal	<b>Settings &gt; Inputs &gt; Proof of Position</b> Type: 4-20 Tolerance: As desired	<a href="#">Analog Input – Self Powered 4-20mA Transmitter</a>
	<b>Settings &gt; Outputs &gt; TCV</b> Purge Position: As desired Pilot Position: As desired Light Off Position As desired	
Temperature control valve with digital proof of light off position switch	<b>Settings &gt; Inputs &gt; Proof of Position</b> Type: Digital All other settings: Ignored	<a href="#">Digital Input – Dry Contact</a> <a href="#">Digital Input – Wet Contact</a>
Not Used	<b>Settings &gt; Inputs &gt; Proof of Light Off</b> Type: Disabled	N/A

When configured in digital mode, the Proof of Position input must be connected to a digital proof of light off position switch. The Auxiliary inputs (terminals 45 & 46 and 47 & 48) must be used if digital proof of pilot position or digital proof of purge position inputs are required.

#### 4.3.3 SYSTEM BEHAVIOR

Type	Scenario			
Setting	Initial System State	PoP Input State	System State Transition	Alerts Pane/Lockout Message
Digital	Startup Checks	De-energized	Proven Pre-Purge	N/A
		Energized	Lockout	Failed to Prove Light Off Position
	Request Light Off Position	De-energized	Lockout	Failed to Prove Light Off Position
		Energized	Main Light Off	N/A
	Main Light Off	De-energized	Lockout	Failed to Prove Light Off Position
		Energized	Process Control	N/A
All not listed above	Any	No effect	N/A	
4-20	Any	Out of Range	Lockout	Proof of Position Out of Range
		Outside tolerance	Lockout	Failed to Prove Purge Position
	Request Purge Position	Within tolerance	Continues with Proven Pre-Purge sequence	N/A
		Outside tolerance	Lockout	Failed to Prove Pilot Position
	Request Pilot Position	Within tolerance	Ignition	N/A
		Outside tolerance	Lockout	Failed to Prove Light Off Position
	Request Light Off Position	Within tolerance	Main Light Off	N/A
		Outside tolerance	Lockout	Failed to Prove Light Off Position
	Main Light Off	Within tolerance	Process Control	N/A
		Any	No effect	N/A
Disabled	Any	Any	No effect	N/A

## 4.4 PROOF OF CLOSURE INPUT

### 4.4.1 DETAILS

Item	
Terminals	11 & 12
Name	POC
Type	Digital input

### 4.4.2 INTENDED FIELD DEVICE CONNECTIONS

Field Device	Configuration Requirements	Connection Diagrams
Main Valve (SSV) Proof of Closure Switch	<b>Settings &gt; Inputs &gt; Proof of Closure</b> Proof of Closure: Enabled	<a href="#">Digital Input – Dry Contact</a> <a href="#">Digital Input – Wet Contact</a>
Not Used	<b>Settings &gt; Inputs &gt; Proof of Closure</b> Proof of Closure: Disabled	N/A

### 4.4.3 SYSTEM BEHAVIOR

Configuration Details	Scenario		State Transition if Running	Alerts Pane
	SSV Output state	POC Input state		
Proof Closure: Enabled	De-energized	De-energized	Lockout	Proof of Closure Contact Open Alarm
	Energized	Energized	No effect	Proof of Closure Contact Failed to Open Warning
	De-energized	Energized	No effect	N/A
	Energized	De-energized	No effect	N/A
Proof Closure: Disabled	Any	Any	No effect	N/A

## 4.5 TEMPERATURE CONTROL VALVE OUTPUT

### 4.5.1 DETAILS

**Item**

Terminals	13 & 14
Name	TCV
Type	4-20mA output

### 4.5.2 INTENDED FIELD DEVICE CONNECTIONS

Field Device	Configuration Requirements	Connection Diagrams
4-20mA Proportional Fuel Gas Valve using internal PID algorithm	<b>Settings &gt; Outputs &gt; TCV</b> All settings: As desired <b>Settings &gt; Inputs &gt; Proof of Position</b> All settings: As desired <b>Settings &gt; Proc Control &gt; Configuration</b> Process Control Mode: PID Control Post Purge Mode: As desired <b>Settings &gt; Proc Control &gt; Timing</b> Position Timeout Settings: As desired <b>Settings &gt; Proc Control &gt; PID Control</b> All settings: As desired	<a href="#">TCV Output Wiring</a>
4-20mA Proportional Fuel Gas Valve using external firing rate input	<b>Settings &gt; Outputs &gt; TCV</b> Min Position: As desired All other settings: Ignored in Process Control state <b>Settings &gt; Inputs &gt; Proof of Position</b> All settings: As desired <b>Settings &gt; Proc Control &gt; Configuration</b> Process Control Mode: External Firing Rate Post Purge Mode: As desired <b>Settings &gt; Proc Control &gt; Timing</b> Position Timeout Settings: As desired <b>Settings &gt; Inputs &gt; Aux 1 or Aux 2</b> Type: 4-20 4-20 Mode: Appliance Firing Rate	<a href="#">TCV Output Wiring</a>
Not Used	N/A	N/A

### 4.5.3 SYSTEM BEHAVIOR

System State	Behavior
Any stopped state	Off Position <sup>1</sup>
Waiting	Off Position <sup>2</sup>
Startup Checks	Off Position
Proven Pre-Purge - Request Purge Position, Prove Airflow, Pre-Purge	Purge Position
Proven Pre-Purge - Request Pilot Position	Pilot Position
Ignition	Pilot Position
Pilot	Pilot Position
Pilot - Request Light Off Position	Light Off Position
Main Light Off	Light Off Position
Process Control - PID Control	Between Minimum Position and 100% per internal PID algorithm
Process Control - External Firing Rate	Between Minimum Position and 100% per external firing rate input
Main Turndown	Light Off Position

<sup>1</sup> When post-purging, TCV output is at its (1) configured **Purge Position** when **Post Purging Mode** setting is set to **Purge Position** or (2) last running position prior to Lockout when **Post Purging Mode** setting is set to **Last Position**

<sup>2</sup> TCV output is at **Purge Position** when system is post purging while in the Waiting state



Warning: The TCV **Manual Override** setting is to be used during commissioning only. Enabling **Manual Override** disables all position proving and may result in an unsafe fuel mixture and/or flame blow-back which may result in death, serious injury, property damage or equipment damage.

## 4.6 PILOT 1 VALVE SOLENOID OUTPUT

### 4.6.1 DETAILS

Item	
Terminals	15 & 16
Name	PILOT 1
Type	Powered solenoid valve output with configurable PWM

### 4.6.2 INTENDED FIELD DEVICE CONNECTIONS

Field Device	Configuration Requirements	Connection Diagrams
Normally Closed Pilot Gas Shutoff Valve - Peak and Hold	<b>Settings &gt; Proc Control &gt; Configuration</b> Pilot Off Mode: As desired Pilot 2: As desired Minimum Pilots Running: As desired Reignition: As desired <b>Settings &gt; Proc Control &gt; Timing</b> Pilot Startup Delay Time: As desired <b>Settings &gt; Outputs &gt; Valves</b> Pilot Valve PWM: As desired	<a href="#">Solenoid Output – 12V/24V</a>
	<b>Settings &gt; Proc Control &gt; Configuration</b> Pilot Off Mode: As desired Pilot 2: As desired Minimum Pilots Running: As desired Reignition: As desired <b>Settings &gt; Proc Control &gt; Timing</b> Pilot Startup Delay Time: As desired <b>Settings &gt; Outputs &gt; Valves</b> Pilot Valve PWM: 100%	<a href="#">Solenoid Output – 12V/24V</a>
Normally Closed Pilot Gas Shutoff Valve – Constant current	<b>Settings &gt; Proc Control &gt; Configuration</b> Pilot Off Mode: As desired Pilot 2: As desired Minimum Pilots Running: As desired Reignition: As desired <b>Settings &gt; Proc Control &gt; Timing</b> Pilot Startup Delay Time: As desired <b>Settings &gt; Outputs &gt; Valves</b> Pilot Valve PWM: 100%	<a href="#">Solenoid Output – 12V/24V</a>

### 4.6.3 SYSTEM BEHAVIOR



System State	Pilot 1 Output
Power On	De-energized
Lockout	De-energized
Alarm	De-energized
Ready	De-energized
Waiting	De-energized
Startup Checks	De-energized
Proven Pre-Purge	De-energized
Ignition	Energized
Pilot	Energized <sup>1</sup>
Main Light Off	Energized <sup>1 2</sup>
Process Control	Energized <sup>1 2</sup>
Main Turndown	Energized <sup>1 2</sup>

<sup>1</sup> De-energized following automatic reignition failure

<sup>2</sup> De-energized when **Pilot Off Mode** is set to **Interrupted**

## Feature Note

### Pilot Off Mode

-  Settings
-  Process Control
-  Configuration

The **Pilot Off Mode** settings allows the user to specify the circumstances at which the pilot valve outputs are to be de-energized to avoid overheating. The Pilot valves will de-energize as follows:

1. **Disabled:** when the process temperature exceeds its configured **High Temp Setpoint**.
2. **Off at Pilot Off Setpoint:** when the process temperature exceeds its configured **Pilot Off Setpoint**
3. **Off at Main Off Setpoint:** when the process temperature exceeds its configured **Main Off Setpoint**
4. **Interrupted:** after successful main light off when monitoring main flame with a UV flame scanner.



## 4.7 PILOT 2 VALVE SOLENOID OUTPUT

### 4.7.1 DETAILS

Item	
Terminals	17 & 18
Name	PILOT 2
Type	Powered solenoid valve output with configurable PWM

### 4.7.2 INTENDED FIELD DEVICE CONNECTIONS

Field Device	Configuration Requirements	Connection Diagrams
Normally Closed Pilot Gas Shutoff Valve - Peak and Hold	<b>Settings &gt; Proc Control &gt; Configuration</b> Pilot Off Mode: As desired Pilot 2: Enabled Minimum Pilots Running: As desired Reignition: As desired <b>Settings &gt; Outputs &gt; Valves</b> Pilot Valve PWM: As desired	<a href="#">Solenoid Output – 12V/24V</a>
Normally Closed Pilot Gas Shutoff Valve – Constant current	<b>Settings &gt; Proc Control &gt; Configuration</b> Pilot Off Mode: As desired Pilot 2: Enabled Minimum Pilots Running: As desired Reignition: As desired <b>Settings &gt; Outputs &gt; Valves</b> Pilot Valve PWM: 100%	<a href="#">Solenoid Output – 12V/24V</a>
Not Used	<b>Settings &gt; Proc Control &gt; Configuration</b> Pilot 2: Disabled	N/A

### 4.7.3 SYSTEM BEHAVIOR



Configuration Details	System State	Pilot 2 Output
Pilot 2: Disabled	Any	De-energized
Pilot 2: Enabled	Power On	De-energized
	Lockout	De-energized
	Alarm	De-energized
	Ready	De-energized
	Waiting	De-energized
	Startup Checks	De-energized
	Proven Pre-Purge	De-energized
	Ignition	Energized
	Pilot	Energized <sup>1</sup>
	Main Light Off	Energized <sup>1 2</sup>
	Process Control	Energized <sup>1 2</sup>
	Main Turndown	Energized <sup>1 2</sup>

<sup>1</sup> De-energized following automatic reignition failure

<sup>2</sup> De-energized when **Pilot Off Mode** is set to **Interrupted**

## Feature Note Pilot Reignition

When the **Reignition** setting is **Enabled**, the system will automatically attempt to relight a lost pilot flame provided there is a proven flame on the other pilot. The system will continue to run in its current state; it will keep the lost pilot valve output energized and will energize its associated coil output to attempt a relight. The coil output will remain energized for 2 minutes or until the flame has been successfully re-established, whichever is shorter. If the flame has not been re-established within the 2 minute time limit, the lost pilot valve output and associated coil output will be de-energized and the system will continue to run with a single pilot flame. After this point, the user must manually initiate reignition using (1) the START button on the keypad, or (2) the external ignition switch if a relight is desired. This will cause the system to transition to the Proven Pre-Purge state to prepare for an ignition attempt. If flame is not detected on at least one pilot at any point during the reignition, the system will abort the reignition sequence and behave as though a flame loss has occurred.

-  Settings
-  Process Control
-  Configuration

Additional Configuration Requirements:  
 Settings > Process Control > Configuration > **Pilot 2: Enabled**  
 Settings > Process Control > Configuration > **Minimum Pilots Running: 1**

## 4.8 MAIN VALVE SOLENOID OUTPUTS

### 4.8.1 DETAILS

Item	
Terminals	19 & 20 and 21 & 22
Name	SSV
Type	Powered solenoid valve output with configurable PWM

### 4.8.2 INTENDED FIELD DEVICE CONNECTIONS

Field Device	Configuration Requirements	Connection Diagrams
Normally Closed Main Gas Shutoff Valves - Peak and Hold	<b>Settings &gt; Outputs &gt; Valves</b> SSV PWM: As desired	<a href="#">Solenoid Output – 12V/24V</a>
Normally Closed Main Gas Shutoff Valves – Constant current	<b>Settings &gt; Outputs &gt; Valves</b> SSV PWM: 100%	<a href="#">Solenoid Output – 12V/24V</a>

### 4.8.3 SYSTEM BEHAVIOR

System State	SSV Outputs
Power On	De-energized
Lockout	De-energized
Alarm	De-energized
Ready	De-energized
Waiting	De-energized
Startup Checks	De-energized
Proven Pre-Purge	De-energized
Ignition	De-energized
Pilot	De-energized
Main Light Off	Energized
Process Control	Energized
Main Turndown	Energized

## 4.9 FAN OUTPUT

### 4.9.1 DETAILS

Item	
Terminals	23 & 24
Name	FAN
Type	Powered output

### 4.9.2 INTENDED FIELD DEVICE CONNECTIONS

Field Device	Configuration Requirements	Connection Diagrams
Forced Draft Fan	<b>Settings &gt; Outputs &gt; Valves</b> Fan Mode: Forced Draft <b>Settings &gt; Inputs &gt; Proof of Airflow</b> All settings: As desired	<a href="#">Fan Output Wiring</a>
Purge Fan for natural draft applications only. * See Warning below	<b>Settings &gt; Outputs &gt; Valves</b> Fan Mode: Purge Only <b>Settings &gt; Inputs &gt; Proof of Airflow</b> All settings: As desired	<a href="#">Fan Output Wiring</a>
Not Used	N/A	N/A

### 4.9.3 SYSTEM BEHAVIOR

System State	Forced Draft Mode	Purge Only Mode
Power On	De-energized	De-energized
Lockout	De-energized <sup>1</sup>	De-energized <sup>1</sup>
Alarm	De-energized <sup>1</sup>	De-energized <sup>1</sup>
Ready	De-energized <sup>1</sup>	De-energized <sup>1</sup>
Waiting	De-energized <sup>1</sup>	De-energized <sup>1</sup>
Startup Checks	De-energized	De-energized
Proven Pre-Purge – Request Purge Position	Energized	Energized
Proven Pre-Purge – Prove Airflow	Energized	Energized
Proven Pre-Purge – Pre-Purge	Energized	Energized
Proven Pre-Purge – Request Pilot Position	Energized	De-energized
Ignition	Energized	De-energized
Pilot	Energized	De-energized
Main Light Off	Energized	De-energized
Process Control	Energized	De-energized
Main Turndown	Energized	De-energized

<sup>1</sup> Energized when system is purging



Warning: The **Purge Only** Fan output mode must not be used for applications which require fan-assisted combustion air. This mode is only intended to be used in natural draft applications where a fan is only required during the purge cycle to lower the purge-time requirement. Improper use of this mode may result in inadequate airflow during combustion causing an unsafe fuel mixture and/or flame blow-back which may result in death, serious injury, property damage or equipment damage.

## 4.10 STATUS CONTACT

### 4.10.1 DETAILS

Item	
Terminals	25 & 27
Name	RUN STATUS
Type	Normally open dry contact

### 4.10.2 INTENDED FIELD DEVICE CONNECTIONS

Field Device	Configuration Requirements	Connection Diagrams
Site equipment status panel	<b>Settings &gt; Outputs &gt; Status</b> Mode: As desired	<a href="#">Run Status – External AC Source</a> <a href="#">Run Status – External DC Source</a> <a href="#">Run Status – BMS Power</a>
Tank pump motor enable via relay	<b>Settings &gt; Outputs &gt; Status</b> Mode: Level/Flow Control Level/Flow Control Setpoint: As desired	<a href="#">Run Status – Pump Control</a>

### 4.10.3 STATUS CONTACT BEHAVIOR

System State	Run Status Mode	Heating Status Mode	Low Temp Warning Mode		Level/Flow Control Mode	
			Process Temp Below Low Temp Setpoint	Process Temp Above Low Temp Setpoint	Level/Flow Input Below Level/Flow Control Setpoint	Level/Flow Input Above Level/Flow Control Setpoint
Power On	OPEN	OPEN	OPEN	OPEN	CLOSED	OPEN
Lockout	OPEN	OPEN	OPEN	OPEN	CLOSED	OPEN
Alarm	OPEN	OPEN	OPEN	OPEN	CLOSED	OPEN
Ready	OPEN	OPEN	OPEN	OPEN	CLOSED	OPEN
Waiting	CLOSED	OPEN	OPEN	CLOSED	CLOSED	OPEN
Startup Checks	CLOSED	OPEN	OPEN	CLOSED	CLOSED	OPEN
Proven Pre-Purge	CLOSED	OPEN	OPEN	CLOSED	CLOSED	OPEN
Ignition	CLOSED	CLOSED	OPEN	CLOSED	CLOSED	OPEN
Pilot	CLOSED	CLOSED	OPEN	CLOSED	CLOSED	OPEN
Main Light Off	CLOSED	CLOSED	OPEN	CLOSED	CLOSED	OPEN
Process Control	CLOSED	CLOSED	OPEN	CLOSED	CLOSED	OPEN
Main Turndown	CLOSED	CLOSED	OPEN	CLOSED	CLOSED	OPEN

### Feature Note Run Status Pump Control

The Run Status dry contact **Mode** can be set to **Level/Flow Control** and used to control a pump motor based on a level or flow input to the BMS. The contact behavior depends on the user configured **Run Status Level/Control Setpoint** that is set independently of the Level/Flow setpoints used for process control. The contact remains closed (pump energized) as long as the measured Level/Flow input reading is below the Run Status Level/Control Setpoint and remains open (pump de-energized) as long as the measured Level/Flow input reading is above the **Run Status Level/Control Setpoint** minus the configured **Level/Flow 4-20 Deadband** setting.

-  Settings
-  Outputs
-  Status

Additional Configuration Requirements:  
 Settings > Inputs > Level/Flow > **Type:** 4-20  
 Settings > Inputs > Level/Flow > **4-20 Span Min/Max:** per transmitter  
 Settings > Inputs > Level/Flow > **4-20 Deadband:** as desired

## 4.11 CONTROLLER POWER INPUT

### 4.11.1 DETAILS

Item	
Terminals	28, 29, 30, 31, 32
Name	POWER IN
Type	BMS power input

### 4.11.2 INTENDED FIELD DEVICE CONNECTIONS

Field Device	Configuration Requirements	Connection Diagrams
12V Power Supply	<b>Settings &gt; Setup &gt; Commissioning</b> Voltage Setting: 12V	<a href="#">Power Input Wiring</a>
24V Power Supply	<b>Settings &gt; Setup &gt; Commissioning</b> Voltage Setting: 24V	<a href="#">Power Input Wiring</a>

Use the Power Diagnostics Screen (System > Diagnostics > Power) to see real time voltage and power consumption numbers.

## 4.12 EMERGENCY SHUTDOWN INPUT

### 4.12.1 DETAILS

Item	
Terminals	33 & 34
Name	ESD
Type	Digital input

### 4.12.2 INTENDED FIELD DEVICE CONNECTIONS

Field Device	Configuration Requirements	Connection Diagrams
External Emergency Stop Pushbutton		<a href="#">Digital Input – Dry Contact</a>
Shutdown signal from PLC	N/A – ESD Input is always enabled	<a href="#">Digital Input – Wet Contact</a>
Plant ESD loop		

### 4.12.3 SYSTEM BEHAVIOR

ESD Input state	State Transition if running	State Transition if Stopped	Alerts Pane
De-energized	Lockout	Alarm	ESD Contact Open Alarm
Energized	No effect	No effect	N/A

## 4.13 REMOTE START INPUT

### 4.13.1 DETAILS

Item	
Terminals	35 & 36
Name	START
Type	Digital input

### 4.13.2 INTENDED FIELD DEVICE CONNECTIONS

Field Device	Configuration Requirements	Connection Diagrams
Remote Control Panel BMS Start Switch	<b>Settings &gt; Inputs &gt; Remote Start</b> Remote Start: Enabled	<a href="#">Digital Input – Dry Contact</a> <a href="#">Digital Input – Wet Contact</a>
Start signal from PLC	<b>Settings &gt; Inputs &gt; Remote Start</b> Remote Start: Enabled	<a href="#">Digital Input – Dry Contact</a> <a href="#">Digital Input – Wet Contact</a>
Not Used	<b>Settings &gt; Inputs &gt; Remote Start</b> Remote Start: Disabled	N/A

### 4.13.3 SYSTEM BEHAVIOR

Configuration Details	Event		State Transition	Alerts Pane
	Initial System State	Start Input State		
Remote Start: Enabled	Any	Energized	No effect	N/A
	Any Stopped	De-energized	No effect	Start Contact Open Wait
	Any Running	De-energized	Waiting <sup>1</sup>	Start Contact Open Wait
	Lockout	Energized to de-energized to energized	Ready/Alarm	N/A
	Ready	Energized to de-energized to energized	Startup	N/A
Remote Start: Disabled	Any	Any	No effect	N/A

<sup>1</sup> System transitions to Waiting state via the Main Turndown state when coming from the Process Control state.

Toggling the Remote Start Input from energized to de-energized to energized within 30 seconds will (1) acknowledge on-screen lockout messages and transition the system out of the Lockout state, or (2) start the system if it is in the Ready state.

## 4.14 AUXILIARY OUTPUTS

### 4.14.1 DETAILS

Item	
Terminals	37 & 38 and 39 & 40
Name	AUX OUT 1 and AUX OUT 2
Type	4-20mA output

### 4.14.2 INTENDED FIELD DEVICE CONNECTIONS

Field Device	Configuration Requirements	Connection Diagrams
BMS Temperature input echo to PLC	<b>Settings &gt; Outputs &gt; Aux</b> Mode: As desired Temp Echo Spans: As desired <b>Settings &gt; Setup &gt; Units</b> Temperature: As desired	<a href="#">Analog Output – 4-20mA echo to PLC</a>
BMS input echo to PLC	<b>Settings &gt; Outputs &gt; Aux</b> Mode: As desired Temp Echo Spans: Ignored	<a href="#">Analog Output – 4-20mA echo to PLC</a>
Modbus Register Echo to PLC	<b>Settings &gt; Outputs &gt; Aux</b> Mode: Modbus Echo Temp Echo Spans: Ignored <b>Settings &gt; Setup &gt; Modbus</b> RTU Communication: Enabled All other settings: As desired <b>Modbus Setup:</b> Write desired value (x10) to <i>Remote Echo for Aux</i> Modbus register	<a href="#">Analog Output – 4-20mA echo to PLC</a>

### 4.14.3 SYSTEM BEHAVIOR

Configuration Details	Aux Out Behavior	Example
Mode: Any Temperature Echo mode	Temperature input value is echoed out on the Aux Output as a 4-20mA signal mapped between the Temp Echo Span values	Mode: Bath Temp Echo Temp Echo Span Min (4mA): 0 °F Temp Echo Span Max (20mA): 100 °F Actual Bath Temperature: 50 °F  Aux Output Value: 12mA
Mode: Any BMS input Echo mode	BMS input value is echoed out on the Aux Output as an identical 4-20mA signal	Mode: Level/Flow Echo Actual Level/Flow Input Value: 12mA  Aux Output Value: 12mA
Mode: Modbus Echo	Value written to <i>Remote Echo for Aux</i> Modbus register is echoed out on the Aux Output as a 4-20mA signal mapped between 0 and 100%. Note: Written value is interpreted as 10x the intended echo value (i.e. value of 255 written to Modbus register corresponds to a 25.5% output)	<b>Settings &gt; Outputs &gt; Aux</b> Mode: Modbus Echo <b>Settings &gt; Setup &gt; Modbus</b> RTU Communication: Enabled Actual value written to <i>Remote Echo for Aux</i> Modbus register: 500 (50.0%)  Aux Output Value: 12mA

Refer to PF2200-FD Modbus Configuration Guide detailed Modbus register information.



## 4.15 LEVEL/FLOW INPUT

### 4.15.1 DETAILS

Item	
Terminals	41 & 42
Name	Level/Flow
Type	Configurable digital or 4-20mA input

### 4.15.2 INTENDED FIELD DEVICE CONNECTIONS

Field Device	Configuration Requirements	Connection Diagrams
Digital level or flow switch	<b>Settings &gt; Inputs &gt; Level/Flow</b> Type: Digital Digital Mode: As desired Level/Flow Delay: As desired All other settings: Ignored <b>System &gt; Customization &gt; Status Priority</b> As desired	<a href="#">Digital Input – Dry Contact</a> <a href="#">Digital Input – Wet Contact</a>
4-20mA level transmitter	<b>Settings &gt; Inputs &gt; Level/Flow</b> Type: 4-20 Digital Mode: Ignored Span Min/Max: Transmitter Min/Max All other settings: As desired <b>Settings &gt; Setup &gt; Units</b> Level: As desired Level/Flow Input Units: Level <b>System &gt; Customization &gt; Status Priority</b> As desired	<a href="#">Analog Input - Loop Powered 4-20mA Transmitter</a> <a href="#">Analog Input – Self Powered 4-20mA Transmitter</a>
4-20mA flow transmitter	<b>Settings &gt; Inputs &gt; Level/Flow</b> Type: 4-20 Digital Mode: Ignored Span Min/Max: Transmitter Min/Max All other settings: As desired <b>Settings &gt; Setup &gt; Units</b> Flow: As desired Level/Flow Input Units: Flow <b>System &gt; Customization &gt; Status Priority</b> As desired	<a href="#">Analog Input - Loop Powered 4-20mA Transmitter</a> <a href="#">Analog Input – Self Powered 4-20mA Transmitter</a>
Not Used	<b>Settings &gt; Inputs &gt; Level/Flow</b> Type: Disabled	N/A

### 4.15.3 SYSTEM BEHAVIOR

	Configuration Details	Level/Flow Input State	State Transition if Running	Alerts Pane
Type: Digital	Digital Mode: Alarm	De-energized	Lockout	Level/Flow Contact Open Alarm
	Digital Mode: Wait	De-energized	Waiting <sup>1</sup>	Level/Flow Contact Open Wait
	Digital Mode: Warning	De-energized	No effect	Level/Flow Contact Open Warning
	Digital Mode: Any	Energized	No effect	N/A
Type: 4-20	Any	Out of Range	Lockout	Level/Flow Range Alarm
	High Trip Mode: Alarm	High	Lockout	High Level/Flow Alarm
	High Trip Mode: Wait	High	Waiting <sup>1</sup>	High Level/Flow Wait
	High Trip Mode: Warning	High	No effect	High Level/Flow Warning
	Low Trip Mode: Alarm	Low	Lockout	Low Level/Flow Alarm
	Low Trip Mode: Wait	Low	Waiting <sup>1</sup>	Low Level/Flow Wait
	Low Trip Mode: Warning	Low	No effect	Low Level/Flow Warning
	Any	Valid Range	No effect	N/A

<sup>1</sup> System transitions to Waiting state via the Main Turndown state when coming from the Process Control state.

## 4.16 PROOF OF AIRFLOW INPUT

### 4.16.1 DETAILS

Item	
Terminals	43 & 44
Name	PROOF OF AIR
Type	Configurable digital or 4-20mA input

### 4.16.2 INTENDED FIELD DEVICE CONNECTIONS

Field Device	Configuration Requirements	Connection Diagrams
Digital proof of airflow switch	<b>Settings &gt; Inputs &gt; Proof of Airflow</b> Type: Digital All other settings: Ignored <b>Settings &gt; Proc Control &gt; Timing</b> Airflow Proving Timeout: As desired	<a href="#">Digital Input - Dry Contact</a> <a href="#">Digital Input - Wet Contact</a>
4-20mA airflow transmitter	<b>Settings &gt; Inputs &gt; Proof of Airflow</b> Type: 4-20 Span Min/Max: Transmitter Min/Max All other settings: As desired <b>Settings &gt; Proc Control &gt; Timing</b> Airflow Proving Timeout: As desired <b>Settings &gt; Setup &gt; Units</b> Airflow: As desired <b>System &gt; Customization &gt; Status Priority</b> As desired	<a href="#">Analog Input - Loop Powered 4-20mA Transmitter</a> <a href="#">Analog Input - Self Powered 4-20mA Transmitter</a>

### 4.16.3 SYSTEM BEHAVIOR

Type Setting	Scenario		System State Transition	Alerts Pane/Lockout Message
	Initial System State	PoA Input State		
Digital	Any	Out of range	Lockout if running Alarm if stopped	Proof of Airflow Out of Range
	Startup Checks	Energized	Lockout	Airflow Input Stuck
		De-energized	Proven Pre-Purge	N/A
	Proven Pre-Purge - Request Purge Position	Any	No effect	N/A
	Proven Pre-Purge - Prove Airflow	Energized	Ignition via Proven Pre-Purge sequence	N/A
	Pre-Purge Request Light Off Position <sup>1</sup>	De-energized	Lockout	Failed to Prove Airflow
	Any Fuel state <sup>1</sup>	Energized	No effect	N/A
		De-energized	Lockout	Failed to Prove Airflow
4-20	Any	Out of range	Lockout if running Alarm if stopped	
	Any	High	Lockout if running Alarm if stopped	High Proof of Airflow
	Startup Checks	Valid range	Lockout	Airflow Input Stuck
		Low	Proven Pre-Purge	N/A
	Proven Pre-Purge - Request Purge Position	Low or valid range	No effect	N/A
	Proven Pre-Purge - Prove Airflow	Valid range	Ignition via Proven Pre-Purge sequence	N/A
	Pre-Purge Request Light Off Position <sup>1</sup>	Low	Lockout	Failed to Prove Airflow
	Any Fuel state <sup>1</sup>	Valid range	No effect	N/A
Low		Lockout	Failed to Prove Airflow	

<sup>1</sup> Proof of Airflow input is ignored in all states after Pre-Purge when **Fan Mode** setting is set to **Purge Only**

## 4.17 AUXILIARY INPUTS

### 4.17.1 DETAILS

Item	
Terminals	45 & 46 and 47 & 48
Name	AUX IN 1 and AUX IN 2
Type	Configurable digital or 4-20mA inputs

### 4.17.2 INTENDED FIELD DEVICE CONNECTIONS

Field Device	Configuration Requirements	Connection Diagrams
Digital input switch or Temperature control valve with digital proof of purge or pilot position switch	<b>Settings &gt; Inputs &gt; Aux 1/2</b> Type: Digital Digital Trip Mode: As desired All other settings: Ignored <b>System &gt; Customization &gt; Status Priority</b> As desired	<a href="#">Digital Input – Dry Contact</a> <a href="#">Digital Input – Wet Contact</a>
4-20mA input transmitter	<b>Settings &gt; Inputs &gt; Aux 1/2</b> Type: 4-20 4-20 Mode: High/Low Trip Digital Trip Mode: Ignored 4-20 Span Min/Max: Transmitter Min/Max All other settings: As desired <b>Settings &gt; Setup &gt; Units</b> Aux In 1/2: As desired <b>System &gt; Customization &gt; Status Priority</b> As desired	<a href="#">Analog Input - Loop Powered 4-20mA Transmitter</a> <a href="#">Analog Input – Self Powered 4-20mA Transmitter</a> <a href="#">Analog Input – Input from PLC</a>
4-20mA flame quality output from UV scanner	<b>Settings &gt; Inputs &gt; Aux 1/2</b> Type: 4-20 4-20 Mode: UV Flame Quality All other settings: Ignored <b>System &gt; Customization &gt; Status Priority</b> As desired	<a href="#">UV Flame Scanner Wiring</a>
External Firing rate input from PLC	<b>Settings &gt; Inputs &gt; Aux 1/2</b> Type: 4-20 4-20 Mode: Appliance Firing Rate All other settings: Ignored <b>Settings &gt; Proc Control &gt; Configuration</b> Process Control Mode: External Firing Rate <b>System &gt; Customization &gt; Status Priority</b> As desired	<a href="#">Analog Input – Input from PLC</a>
External Bath <sup>1</sup> Setpoint adjustment input from PLC	<b>Settings &gt; Inputs &gt; Aux 1/2</b> Type: 4-20 4-20 Mode: Bath <sup>1</sup> Process SP Adjust 4-20 Span Min/Max: As desired All other settings: Ignored <b>Settings &gt; Temps &gt; Bath<sup>1</sup></b> Mode: Process Control <b>Settings &gt; Setup &gt; Units</b> Aux In X: Temperature <b>System &gt; Customization &gt; Status Priority</b> As desired	<a href="#">Analog Input – Input from PLC</a>
Not Used	<b>Settings &gt; Inputs &gt; Aux 1/2</b> Type: Disabled	N/A

<sup>1</sup> Aux Input can also be configured as a setpoint adjustment input for the Outlet temperature input.

4.17.3 SYSTEM BEHAVIOR

	Configuration Details	Aux In Input State	State Transition if Running	Alerts Pane
Type: Digital	Digital Mode: Alarm	De-energized	Lockout	Aux In Contact Open Alarm
	Digital Mode: Wait	De-energized	Waiting	Aux In Contact Open Wait
	Digital Mode: Warning	De-energized	No effect	Aux In Contact Open Warning
	Digital Mode: Main Permissive	De-energized	Pilot – from main fuel state No effect otherwise	Aux In Contact Open Main Permissive
	Digital Mode: Any Above	Energized	No effect	N/A
Type: 4-20 Mode: High/Low Trip	High Trip Mode: Alarm	Too high	Lockout	Aux In High Trip Alarm
	High Trip Mode: Wait	Too high	Waiting	Aux In High Trip Wait
	High Trip Mode: Warning	Too high	No effect	Aux In High Trip Warning
	High Trip Mode: Main Permissive	Too high	Pilot – from main fuel state No effect otherwise	Aux In High Trip Main Permissive
	Low Trip Mode: Alarm	Too low	Lockout	Aux In Low Trip Alarm
	Low Trip Mode: Wait	Too low	Waiting	Aux In Low Trip Wait
	Low Trip Mode: Warning	Too low	No effect	Aux In Low Trip Warning
	Low Trip Mode: Main Permissive	Too low	Pilot – from main fuel state No effect otherwise	Aux In Low Trip Main Permissive
Type: 4-20 Mode: Any	Any	Out of Range	Lockout	Aux In Range Alarm
	Any	Valid Range	No effect	N/A



4.17.4 SYSTEM BEHAVIOR – DIGITAL PROOF OF PURGE

Digital Mode	Initial System State	Aux In Input State	State Transition	Alerts Pane
Purge Position	Startup Checks	De-energized	No effect	N/A
	Proven Pre-Purge - Request Purge Position	Energized	Lockout	Failed to Prove Purge Position
		De-energized	Lockout	Failed to Prove Purge Position
	Proven Pre-Purge - Prove Airflow	Energized	No effect	No effect
	Proven Pre-Purge - Pre-Purge	Energized	No effect	No effect
Any state not listed above	Any	No effect	N/A	

4.17.5 SYSTEM BEHAVIOR – DIGITAL PROOF OF PILOT

Digital Mode	Initial System State	Aux In Input State	State Transition	Alerts Pane
Pilot Position	Startup Checks	De-energized	No effect	N/A
	Proven Pre-Purge - Request Pilot Position	Energized	Lockout	Failed to Prove Pilot Position
		De-energized	Lockout	Failed to Prove Pilot Position
	Ignition Pilot	De-energized	Lockout	Failed to Prove Pilot Position
	Pilot – Pilot Startup Delay	Energized	No effect	No effect
	Any state not listed above	Any	No effect	N/A

**Feature Note**  
**Process Setpoint Adjustment Input**

-  Settings
-  Inputs
-  Aux In 1/Aux In 2

Configuring the **Aux In 4-20 Mode** setting as **Process SP Adjust** allows a process setpoint to be updated remotely from an external 4-20mA signal. This can be used for applications that require seasonal setpoint adjustments or other process temperature compensation. The Process Setpoint Adjust input can change the configured **Process Setpoint** of a desired temperature input between its configured **Low Temp Setpoint** and **Main Off Setpoint**. A 4mA input signal corresponds to the configured **Aux In 4-20 Span Min** setting and a 20mA input signal corresponds to the configured **Aux In 4-20 Span Max** setting. The Process Setpoint will be clamped between the configured **Low Temp Setpoint** and **Main Off Setpoint** regardless of the setpoint adjustment input signal (e.g. All setpoint adjustment signals below the configured **Low Temp Setpoint** will change the **Process Setpoint** to match the **Low Temp Setpoint**.)

## 4.18 UV FLAME DETECTION INPUTS

### 4.18.1 DETAILS

Item	
Terminals	49, 50, 51, 52
Name	UV SCANNER
Type	Digital inputs

### 4.18.2 INTENDED FIELD DEVICE CONNECTIONS

Field Device	Configuration Requirements	Connection Diagrams
UV main flame scanner	<b>Settings &gt; Proc Control &gt; Configuration</b> UV Flame Detect Mode: Main Only Pilot Off Mode: As desired <b>Settings &gt; Inputs &gt; Aux 1/2</b> Configure for UV flame quality if desired <b>System &gt; Customization &gt; Status Priority</b> As desired	<a href="#">UV Flame Scanner Wiring</a>
UV pilot and main flame scanner	<b>Settings &gt; Proc Control &gt; Configuration</b> UV Flame Detect Mode: Pilot and Main Pilot Off Mode: Interrupted Pilot 2: Disabled <b>Settings &gt; Inputs &gt; Aux 1/2</b> Configure for UV flame quality if desired <b>System &gt; Customization &gt; Status Priority</b> As desired	<a href="#">UV Flame Scanner Wiring</a>
Not Used	<b>Settings &gt; Proc Control &gt; Configuration</b> UV Flame Detect Mode: Disabled	N/A

The PF2200-FD supports flame scanners with digital outputs for (1) device fault, (2) flame presence detected and (3) flame absence detected. The flame failure response time of the flame scanner must be 3 seconds or less to ensure that the overall UV flame failure response time of the system is within 4 seconds. A 4-20mA flame quality output is optional. The following UV flame scanners are approved for use with the PF2200-FD:

1. Fireye 65UV5-1004E
2. Zeeco ZPF-120 \*

\* Zeeco ZPF-120 scanner does not have a separate fault output. Internal faults are conveyed as a mismatch on the Flame On and Flame Off outputs. When using this scanner, the UV PWR output and UV Fault input (terminals 49 and 50) must be shorted together with a jumper. Note that a scanner fault will be annunciated in the Alerts Pane as a UV Flame Detect Mismatch.

### 4.18.3 SYSTEM BEHAVIOR – UV FAULT INPUT

UV Fault Input state	State Transition if running	State Transition if Stopped	Alerts Pane
De-energized	Lockout	Alarm	UV Flame Detect Fault Alarm
Energized	No effect	No effect	N/A

### 4.18.4 SYSTEM BEHAVIOR – UV FLAME ON AND FLAME OFF INPUTS

UV Flame On Input state	UV Flame Off Input State	System Interpretation	State Transition if Running	State Transition if Stopped	Alerts Pane
De-energized	De-energized	Mismatch	Lockout	Alarm	UV Flame Detect Mismatch Alarm
Energized	Energized	Mismatch	Lockout	Alarm	N/A
De-energized	Energized	UV flame absent	Refer to Operating Sequence Section for state specific behavior		N/A
Energized	De-energized	UV flame present			N/A

## 4.19 PILOT IGNITION I/O

### 4.19.1 DETAILS

Item	
Terminals	53, 54, 55, 56 and 57, 58, 59, 60
Name	PILOT 1 ION/COIL and PILOT 2 ION/COIL
Type	ION – Ionization flame detection signal utilizing flame rectification COIL – Powered ignition output

### 4.19.2 INTENDED FIELD DEVICE CONNECTIONS

Field Device	Configuration Requirements	Connection Diagrams
Profire Ignition Coil	<b>Settings &gt; Proc Control &gt; Ignition</b> Mode: Coil	<a href="#">Single Rod Ignition Wiring</a>
	<b>Settings &gt; Proc Control &gt; Configuration</b> Pilot 2: As desired	<a href="#">Dual Rod Ignition Wiring</a>
Separate ignition module with DC input	<b>Settings &gt; Proc Control &gt; Ignition</b> Mode: HEI	<a href="#">Dual Rod Ignition Wiring</a>
	<b>Settings &gt; Proc Control &gt; Configuration</b> Pilot 2: As desired	

### 4.19.3 SYSTEM BEHAVIOR – COIL OUTPUTS

Configuration Details	System State	Coil 1 Output Behavior	Coil 2 Output Behavior
Mode: Coil	Ignition	Energized - Pulsed	De-energized <sup>2</sup>
	Any other state	De-energized <sup>1</sup>	De-energized <sup>2</sup>
Mode: HEI	Ignition	Energized - Steady	De-energized <sup>2</sup>
	Any other state	De-energized <sup>1</sup>	De-energized <sup>2</sup>

<sup>1</sup> Energized under Reignition conditions when **Reignition** setting is **Enabled**

<sup>2</sup> Follows behavior of Coil 1 output when **Pilot 2** is **Enabled**

### 4.19.4 SYSTEM BEHAVIOR – IONIZATION INPUTS

Flame Voltage Readings	System Interpretation	
Strength	Greater than 800 mV	Strong Flame Detected
	Between 400 mV and 800 mV	Weak Flame Detected
	Less than 400 mV	No Flame Detected
DC High	Above 2500 mV	Flame Voltage is within acceptable range
	Below 2500 mV	Flame Voltage Fault
AC	Above 500 mV <sub>pk-pk</sub>	Flame Load Monitor Check passed
	Below 500 mV <sub>pk-pk</sub>	Flame Load Monitor Check failed

Check the Flame Diagnostics Screen (System > Diagnostics > Flame) to see real-time flame strength and voltage readings.

### 4.19.5 SYSTEM BEHAVIOR – FLAME DETECTION

Configuration Details	Pilot 1 Flame Presence	Pilot 2 Flame Presence	System Interpretation
Pilot 2: Disabled	Present	Any	Pilot flame present
	Absent	Any	Pilot flame absent
Pilot 2: Enabled	Present	Any	Pilot flame present
	Any	Present	Pilot flame present
Minimum Pilots Running: 1	Absent	Absent	Pilot flame absent
	Present	Present	Pilot flame present
Pilot 2: Enabled	Absent	Any	Pilot flame absent
	Any	Absent	Pilot flame absent

## 4.20 EXTERNAL IGNITION SWITCH INPUT

### 4.20.1 DETAILS

**Item**

Terminals	PWR, IGN, RUN
Name	SWITCH
Type	Digital input

### 4.20.2 INTENDED FIELD DEVICE CONNECTIONS

Field Device	Configuration Requirements	Connection Instructions
Profire PF2200 Ignition Switch	N/A – Always enabled	Connect factory wired switch connector to BMS Switch terminal header.
Not Used	N/A – Always enabled	Add wire jumper between Switch PWR and RUN terminals

### 4.20.3 SYSTEM BEHAVIOR

Initial Burner state	External Switch Position	State Transition	Alerts Pane
Any	Run	No effect	N/A
Any	Ignite for less than 1s	No effect	N/A
Ready	Ignite for more than 1s	Startup	N/A
Any fuel state	Ignite for more than 1s	Proven Pre-Purge	N/A
Any non-running state	Ignite for more than 5s	Alarm	External Switch Stuck Alarm
Any running state	Ignite for more than 5s	Lockout	External Switch Stuck Alarm
Any non-running state	Stop	Alarm	User Stop via External Switch Alarm
Any running state	Stop	Lockout	User Stop via External Switch Alarm
Lockout	Run to Stop to Run	Ready/Alarm	N/A

Toggling the External Ignition Switch from Run position to Stop position to Run position within 30 seconds will acknowledge on-screen lockout messages and transition the system out of the Lockout state. Toggling the External Ignition Switch to the Ignite position while in a fuel state will transition the system to the Proven Pre-Purge state and initiate pilot reignition. This is useful upon loss of a single pilot flame when controlling a dual pilot application; the pilots can be reignited without stopping the system.

## 4.21 BATH TEMPERATURE INPUT

### 4.21.1 DETAILS

Item	
Terminals	61, 62, 63 and 64, 65, 66
Name	BATH
Type	Configurable Type K Thermocouple or PT-100 RTD temperature input

### 4.21.2 INTENDED FIELD DEVICE CONNECTIONS

Field Device	Configuration Requirements	Connection Diagrams
Type K Thermocouple installed in Appliance Bath (Grounded or Ungrounded)	<b>Settings &gt; Temps &gt; Bath</b> Type: TC Input: As desired <sup>1</sup> All other settings: As desired <b>Settings &gt; Proc Control &gt; Configuration</b> Process Control Mode: As desired Pilot Off Mode: As desired <b>Settings &gt; Setup &gt; Units</b> Temperature: As desired <b>System &gt; Customization &gt; Status Priority</b> As desired	<a href="#">Temperature Input- Dual Type K Thermocouple</a> <a href="#">Temperature Input- Single Type K Thermocouple</a>
PT100 RTD installed in Appliance Bath	<b>Settings &gt; Temps &gt; Bath</b> Type: RTD Input: As desired <sup>1</sup> All other settings: As desired <b>Settings &gt; Proc Control &gt; Configuration</b> Process Control Mode: As desired Pilot Off Mode: As desired <b>Settings &gt; Setup &gt; Units</b> Temperature: As desired <b>System &gt; Customization &gt; Status Priority</b> As desired	<a href="#">Temperature Input- Dual 3-Wire RTD</a> <a href="#">Temperature Input- Single 3-wire RTD</a>

<sup>1</sup> Bath **Input** setting is required to be set to **Dual** if the Bath Input is specified as a safety function.

### 4.21.3 SYSTEM BEHAVIOR

Temperature Reading	State transition when running for each Bath Input Mode	
	Process Control	High Temp ESD
Open/Out of Range	Lockout	Lockout
Short in RTD Mode	Lockout	Lockout
Above High Temp Setpoint	Lockout	Lockout
Below High Temp Setpoint and Above Pilot Off Setpoint		No effect
Below Pilot Off Setpoint and Above Main Off Setpoint		No effect
Below Main Off Setpoint and Above Process Setpoint	Refer to Operating Sequence Section for state specific behavior	No effect
Below Process Setpoint and Above Low Temp Setpoint		No effect
Below Low Temp Setpoint		No effect



## 4.22 OUTLET TEMPERATURE INPUT

### 4.22.1 DETAILS

Item	
Terminals	67, 68, 69
Name	OUTLET
Type	Configurable Type K Thermocouple or PT-100 RTD temperature input

### 4.22.2 INTENDED FIELD DEVICE CONNECTIONS

Field Device	Configuration Requirements	Connection Diagrams
Single Element Type K Thermocouple installed at Appliance Outlet (Grounded or Ungrounded)	<b>Settings &gt; Temps &gt; Outlet</b> Type: TC Mode: As desired <b>Settings &gt; Setup &gt; Units</b> Temperature: As desired <b>System &gt; Customization &gt; Status Priority</b> As desired	<a href="#">Temperature Input- Single Type K Thermocouple</a>
Single Element PT100 RTD installed at Appliance Outlet	<b>Settings &gt; Temps &gt; Outlet</b> Type: RTD Mode: As desired <b>Settings &gt; Setup &gt; Units</b> Temperature: As desired <b>System &gt; Customization &gt; Status Priority</b> As desired	<a href="#">Temperature Input- Single 3-wire RTD</a>
Not Used	<b>Settings &gt; Temps &gt; Outlet</b> Mode: Disabled	N/A

### 4.22.3 SYSTEM BEHAVIOR

Temperature Reading	State transition when running for each Outlet Input Mode			
	Process Control	High Temp ESD	Display Only	Disabled
Open/Out of Range	Lockout	Lockout	No effect*	No effect
Short in RTD Mode	Lockout	Lockout	No effect	No effect
Above High Temp Setpoint	Lockout	Lockout	No effect	No effect
Below High Temp Setpoint and Above Pilot Off Setpoint		No effect	No effect	No effect
Below Pilot Off Setpoint and Above Main Off Setpoint	Refer to Operating	No effect	No effect	No effect
Below Main Off Setpoint and Above Process Setpoint	Sequence Section for	No effect	No effect	No effect
Below Process Setpoint and Above Low Temp Setpoint	state specific behavior	No effect	No effect	No effect
Below Low Temp Setpoint		No effect	No effect	No effect

\* Out of Range warning displayed in Alerts Pane

## 4.23 STACK TEMPERATURE INPUT

### 4.23.1 DETAILS

Item	
Terminals	70, 71, 72
Name	STACK
Type	Configurable Type K Thermocouple or PT-100 RTD temperature input

### 4.23.2 INTENDED FIELD DEVICE CONNECTIONS

Field Device	Configuration Requirements	Connection Diagrams
Single Element Type K Thermocouple installed in Appliance Stack (Grounded or Ungrounded)	<b>Settings &gt; Temps &gt; Stack</b> Type: TC Mode: As desired <b>Settings &gt; Setup &gt; Units</b> Temperature: As desired <b>System &gt; Customization &gt; Status Priority</b> As desired	<a href="#">Temperature Input- Single Type K Thermocouple</a>
Single Element PT100 RTD installed in Appliance Stack	<b>Settings &gt; Temps &gt; Stack</b> Type: RTD Mode: As desired <b>Settings &gt; Setup &gt; Units</b> Temperature: As desired <b>System &gt; Customization &gt; Status Priority</b> As desired	<a href="#">Temperature Input- Single 3-wire RTD</a>
Not Used	<b>Settings &gt; Temps &gt; Stack</b> Mode: Disabled	N/A

### 4.23.3 SYSTEM BEHAVIOR

Temperature Reading	State transition when running for each Stack Input Mode		
	High Temp ESD	Display Only	Disabled
Open/Out of Range	Lockout	No effect*	No effect
Short in RTD Mode	Lockout	No effect	No effect
Above High Temp Setpoint	Lockout	No effect	No effect
Below High Temp Setpoint	No effect	No effect	No effect

\* Out of Range warning displayed in Alerts Pane

# 5 OPERATING SEQUENCE

The PF2200-FD utilizes a state-based control scheme to safely monitor and control a burner. Each system state has specific entry and exit requirements and defined output behavior. The sections below outline the system transitions, output behavior and configuration settings related to each system state.

The current system state is always displayed in the Status Bar located at the top of the User Interface screen.

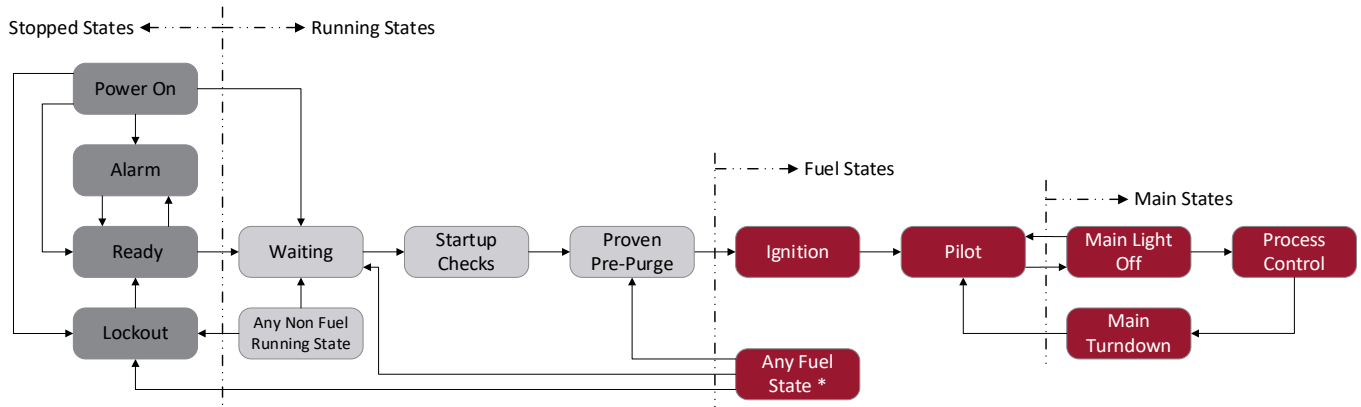

\* The system cannot transition from the Process Control state to the Waiting state without going through the Main Turndown state first.

State Name	Coil Outputs	Pilot Outputs	SSV Outputs	Fan Output
Power On	De-energized	De-energized	De-energized	De-energized
Alarm	De-energized	De-energized	De-energized	De-energized <sup>3</sup>
Ready	De-energized	De-energized	De-energized	De-energized <sup>3</sup>
Lockout	De-energized	De-energized	De-energized	De-energized <sup>3</sup>
Waiting	De-energized	De-energized	De-energized	De-energized <sup>3</sup>
Startup Checks	De-energized	De-energized	De-energized	De-energized
Proven Pre-Purge	De-energized	De-energized	De-energized	Energized <sup>4</sup>
Ignition	Energized	Energized	De-energized	Energized <sup>5</sup>
Pilot	De-energized <sup>1</sup>	Energized	De-energized	Energized <sup>5</sup>
Main Light Off	De-energized <sup>1</sup>	Energized <sup>2</sup>	Energized	Energized <sup>5</sup>
Process Control	De-energized <sup>1</sup>	Energized <sup>2</sup>	Energized	Energized <sup>5</sup>
Main Turndown	De-energized <sup>1</sup>	Energized <sup>2</sup>	Energized	Energized <sup>5</sup>

<sup>1</sup> Coil outputs can be energized in this state upon flame loss when **Reignition** setting is **Enabled**

<sup>2</sup> Pilot outputs are de-energized in this state when **Pilot Off Mode** is set to **Interrupted**

<sup>3</sup> Fan output is energized when system is post-purging

<sup>4</sup> Fan output is de-energized when **Fan Mode** is set to **Purge Only** and system is in Request Pilot Position stage of the Proven Pre-Purge state.

<sup>5</sup> Fan output is de-energized when **Fan Mode** is set to **Purge Only**

Alert types displayed in the Alerts Pane on the Status Screen:

1. **Alarm** – Prevents the system from entering any running state.
2. **Wait** – Prevents the system from entering any fuel state.
3. **Main Permissive** – Prevents the system from entering any main fuel state.
4. **Warning** – Displayed on screen only - does not affect system state.

## 5.1 POWER ON STATE

The Power On state is the default state of the system upon initial powered up. All safety outputs are de-energized upon entering the state.

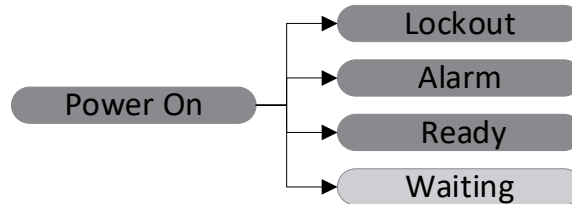

### 5.1.1 POWERED OUTPUT BEHAVIOR IN THE POWER ON STATE

Output	Behavior
Coil 1 Output	De-energized
Coil 2 Output	De-energized
Pilot 1 Valve Output	De-energized
Pilot 2 Valve Output	De-energized
Main SSV Outputs	De-energized
Fan Output	De-energized <sup>1</sup>
TCV Output	Off Position

<sup>1</sup> Fan output is energized until purge time has elapsed if system was purging at last power down

### 5.1.2 TRANSITIONS TO THE POWER ON STATE

From	Scenario	Condition
Power Off	System has just powered up	Any

### 5.1.3 TRANSITIONS FROM THE POWER ON STATE

To	Scenario	Condition
Lockout	Any	Unacknowledged lockout message present at last power down
Alarm	Any	Alarm condition present
Ready	Burner was not running at last power down	<b>Voltage Restart</b> setting <b>Enabled</b> , AND No alarm condition present
	Any	<b>Voltage Restart</b> setting <b>Disabled</b> , AND No alarm condition present
Waiting	System was running at last power down	<b>Voltage Restart</b> setting <b>Enabled</b> , AND No alarm condition present

The **Voltage Restart** setting dictates whether a running system will be automatically restarted following a power loss event. The system will only restart automatically if there are no alarms present.

### 5.1.4 RELATED SETTINGS – POWER ON STATE

Setting	Navigation
Voltage Restart	Settings > Setup > Commissioning

## 5.2 LOCKOUT STATE

The Lockout state holds all safety outputs in the de-energized position, triggers a post purge and prevents the system from entering any other state until the user acknowledges an on-screen lockout message.

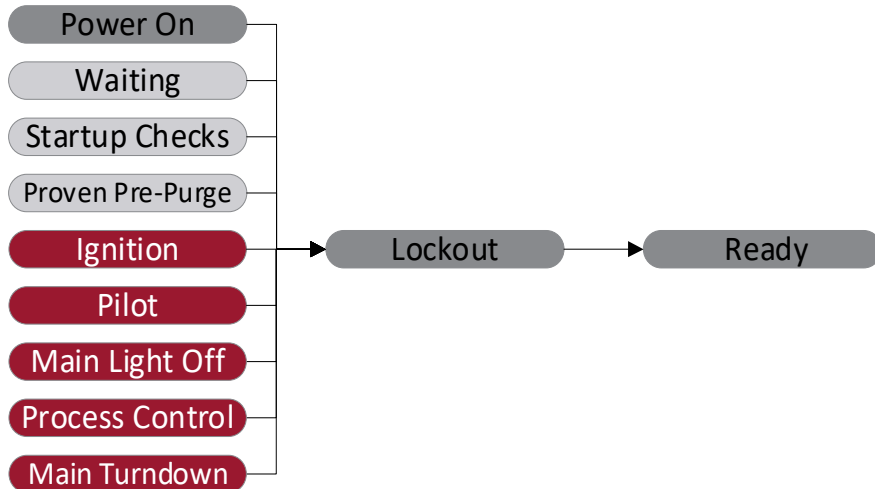

### 5.2.1 POWERED OUTPUT BEHAVIOR IN THE LOCKOUT STATE

Output	Behavior
Coil 1 Output	De-energized
Coil 2 Output	De-energized
Pilot 1 Valve Output	De-energized
Pilot 2 Valve Output	De-energized
Main SSV Outputs	De-energized
Fan Output	De-energized <sup>1</sup>
TCV Output	Off Position <sup>2</sup>

<sup>1</sup> Fan Output is energized while system is purging

<sup>2</sup> TCV Output will (1) remain in its pre-Lockout position or (2) move to its configured **Purge Position** while system is purging and **Post Purge Mode** setting is set to **Last Position** or **Purge Position**, respectively.

### 5.2.2 TRANSITIONS TO THE LOCKOUT STATE

From	Scenario	Condition
Power On	System has just powered up	Lockout message present at last power down
Waiting	Any	Alarm condition present
	System stopped by user	Any
Startup Checks	Any	Alarm condition present
	Flame Detected	Any
	System stopped by user	Any
	Airflow Failure	Any
Proven Pre-Purge	Proof of Position Failure	PoP/Aux In configured for position proving
	Any	Alarm condition present
	System stopped by user	Any
	Failed to prove purge position	PoP/Aux In configured for purge position proving
Ignition	Failed to prove airflow	Any
	Failed to prove pilot position	PoP/Aux In configured for pilot position proving
	Any	Alarm condition present
	System stopped by user	Any
Pilot	Pilot fails to ignite	Ignition attempt limit has been exceeded
	Any	Alarm condition present
	System stopped by user	Any
	Flame failure	<b>Relight Attempts</b> limit has been exceeded
Main Light Off	Failed to prove light off position	System is in Request Light Off Position stage of Pilot state AND Proof of Position <b>Type</b> is not <b>Disabled</b>
	Main Flame detected	System is in Request Light Off Position stage of Pilot state AND <b>UV Flame Detect Mode</b> is set to <b>Main Only</b>
	Any	Alarm condition present
Process Control	System stopped by user	Any
Main Turndown	Flame failure	<b>Relight Attempts</b> limit has been exceeded

There are 4 ways to stop the system:

1. USER INTERFACE: Press **STOP** then confirm by pressing **OK** or **STOP** again.
2. START/STOP SWITCH: Turn switch to STOP position.
3. ESD INPUT: Toggle input to de-energized position.
4. MODBUS: Write Stop command to the Start/Stop Modbus register.

Refer to the Forced Draft Modbus Configuration Guide for Modbus register addresses and commands.

**5.2.3 TRANSITIONS FROM THE LOCKOUT STATE**

To	Scenario	Condition
Ready	Lockout message acknowledged by user	No alarm condition present

There are 4 ways to acknowledge a Lockout:

1. USER INTERFACE: Press  on the keypad.
2. START/STOP SWITCH: Toggle switch from RUN to STOP to RUN position.
3. REMOTE START INPUT: Toggle input from energized to de-energized to energized.
4. MODBUS: Write Acknowledge command to the Clear Shutdown Code Modbus register.

Refer to the Forced Draft Modbus Configuration Guide for Modbus register addresses and commands.

**5.2.4 RELATED SETTINGS – LOCKOUT STATE**

Setting	Navigation
Relight Attempts	Settings > Proc Control > Ignition
Purge Time	Settings > Proc Control > Timing
Remote Start	Settings > Inputs > Remote Start
RTU Communication	Settings > Setup > Modbus

### 5.3 ALARM STATE

The Alarm state is the state to which the system will transition when an alarm is present and the system is not running. The system cannot transition out of the Alarm state until all alarms are cleared. Check the Alerts Pane on the screen to see a list of active alarms.



#### 5.3.1 POWERED OUTPUT BEHAVIOR IN THE ALARM STATE

Output	Behavior
Coil 1 Output	De-energized
Coil 2 Output	De-energized
Pilot 1 Valve Output	De-energized
Pilot 2 Valve Output	De-energized
Main SSV Outputs	De-energized
Fan Output	De-energized <sup>1</sup>
TCV Output	Off Position <sup>2</sup>

<sup>1</sup> Fan Output is energized while system is purging

<sup>2</sup> TCV Output will (1) remain in its pre-Lockout position or (2) move to its configured **Purge Position** while system is purging and **Post Purge Mode** setting is set to **Last Position** or **Purge Position**, respectively.

#### 5.3.2 TRANSITIONS TO THE ALARM STATE

From	Scenario	Condition
Power On	System has just powered up	Alarm condition present
Ready	Any	Alarm condition present

#### 5.3.3 TRANSITIONS FROM THE ALARM STATE

To	Scenario	Condition
Ready	Any	No alarm conditions present

The UI Alerts Pane only displays active alerts – once an alarm condition is cleared, the corresponding alarm is removed from the Alerts Pane. Check the Event Log (System Screen > Logging > Events) for a history of all alarm events.

#### 5.3.4 RELATED SETTINGS – ALARM STATE

Setting	Navigation
Comm Loss Alarm	Settings > Setup > Commissioning



## 5.4 READY STATE

The Ready state is the state to which the system transitions when all alarm conditions are cleared and the system is safe to start. Users are only able to start the system from the Ready state.

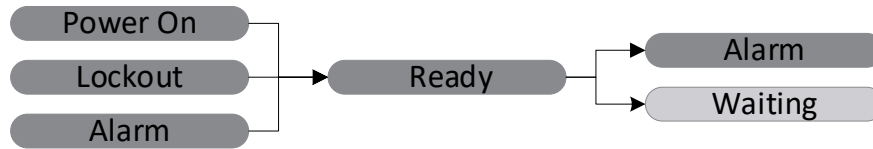

### 5.4.1 POWERED OUTPUT BEHAVIOR IN THE READY STATE

Output	Behavior
Coil 1 Output	De-energized
Coil 2 Output	De-energized
Pilot 1 Valve Output	De-energized
Pilot 2 Valve Output	De-energized
Main SSV Outputs	De-energized
Fan Output	De-energized <sup>1</sup>
TCV Output	Off Position <sup>2</sup>

<sup>1</sup> Fan Output is energized while system is purging

<sup>2</sup> TCV Output will (1) remain in its pre-Lockout position or (2) move to its configured **Purge Position** while system is purging and **Post Purge Mode** setting is set to **Last Position** or **Purge Position**, respectively.

### 5.4.2 TRANSITIONS TO THE READY STATE

From	Scenario	Condition
Power On	System has just powered up	No alarm conditions present
Lockout	Lockout message acknowledged by user	No alarm conditions present
Alarm	Alarm condition has been cleared	No additional alarm conditions present

### 5.4.3 TRANSITIONS FROM THE READY STATE

To	Scenario	Condition
Alarm	Any	Alarm condition present
Waiting	Burner started by user	Any

There are 4 ways to start a burner from the Ready state:

1. USER INTERFACE: Press **START** and confirm start by pressing **OK**.
2. START/STOP SWITCH: Turn switch to the Ignite position and hold for 1 second.
3. REMOTE START INPUT: Toggle input from energized to de-energized to energized.
4. MODBUS: Write Start command to the Start Stop Modbus register.

Refer to the Modbus Register Document for register addresses and commands.

### 5.4.4 RELATED SETTINGS – READY STATE

Setting	Navigation
Remote Start	Settings > Inputs > Remote Start
RTU Communication	Settings > Setup > Modbus

## 5.5 WAITING STATE

The Waiting state is a running state that does not admit fuel to the burner. The system will initiate a post purge when entering the Waiting state from a fuel state. The burner will only proceed to the Startup Checks state when all wait conditions are cleared.

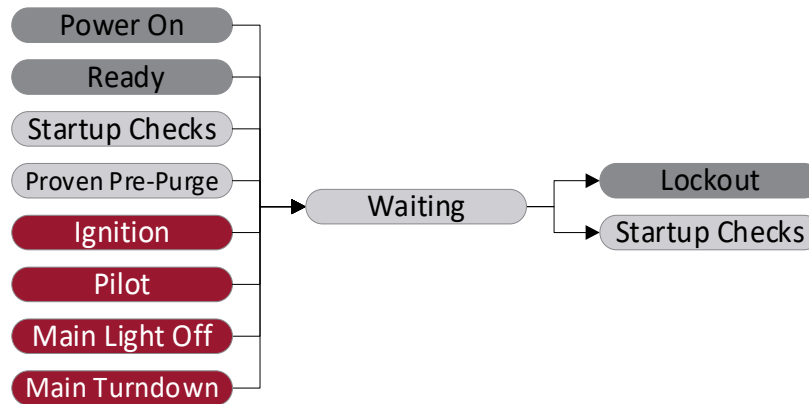

### 5.5.1 POWERED OUTPUT BEHAVIOR IN THE WAITING STATE

Output	Behavior
Coil 1 Output	De-energized
Coil 2 Output	De-energized
Pilot 1 Valve Output	De-energized
Pilot 2 Valve Output	De-energized
Main SSV Outputs	De-energized
Fan Output	De-energized <sup>1</sup>
TCV Output	Off Position <sup>2</sup>

<sup>1</sup> Fan Output is energized while system is purging

<sup>2</sup> TCV Output will move to its configured **Purge Position** while system is purging.

### 5.5.2 TRANSITIONS TO THE WAITING STATE

From	Scenario	Condition
Power On	System was running at last power down	<b>Voltage Restart</b> setting <b>Enabled</b> , AND No alarm condition present
Ready	System started by user	Any
Startup Checks	Any	Wait condition is present
Proven Pre-Purge		
Ignition		
Pilot		
Main Light Off		
Main Turndown	Main Turndown complete	Wait condition is present

### 5.5.3 TRANSITIONS FROM THE WAITING STATE

To	Scenario	Condition
Lockout	Any	Alarm condition present
	System stopped by user	Any
Startup Checks	Any	All waits have been cleared

### 5.5.4 RELATED SETTINGS - WAITING STATE

Setting	Navigation
Voltage Restart	Settings > Setup > Commissioning

## 5.6 STARTUP CHECKS STATE

The Startup Checks state is a running state that does not admit fuel to the burner. The system will initiate a series of safety checks to ensure that the system is in a known state before proceeding to the Proven Pre-Purge state to prepare for an ignition attempt. The burner will only proceed to the Proven Pre-Purge state when all the following safety checks are successful:

1. Confirm no flame is detected
2. Confirm Light Off Position input is not satisfied \*
3. Confirm Pilot Position input is not satisfied \*
4. Confirm Purge Position input is not satisfied \*
5. Confirm Proof of Airflow input is not satisfied

\* Ignored if not enabled

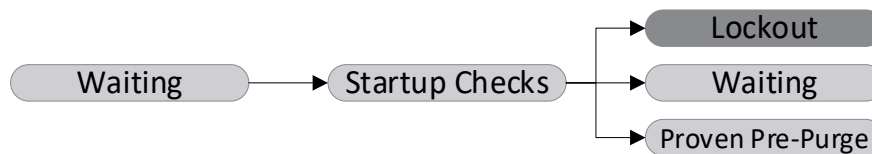

### 5.6.1 POWERED OUTPUT BEHAVIOR IN THE STARTUP CHECKS STATE

Output	Behavior
Coil 1 Output	De-energized
Coil 2 Output	De-energized
Pilot 1 Valve Output	De-energized
Pilot 2 Valve Output	De-energized
Main SSV Outputs	De-energized
Fan Output	De-energized
TCV Output	Off Position

### 5.6.2 TRANSITIONS TO THE STARTUP CHECKS STATE

From	Scenario	Condition
Waiting	Any	All waits have been cleared

### 5.6.3 TRANSITIONS FROM THE STARTUP CHECKS STATE

To	Scenario	Condition
Lockout	Any	Alarm condition is present
	System stopped by user	Any
	Flame detected	Any
	Airflow failure	Any
	Proof of Position failure	PoP/Aux input configured for position proving
Waiting	Any	Wait condition is present
Proven Pre-Purge	Any	All startup checks successful

### 5.6.4 RELATED SETTINGS – STARTUP CHECKS STATE

Setting	Navigation
Startup Check Timeout	Settings > Proc Control > Timing
Proof of Position Type	Settings > Inputs > Proof of Position
Proof of Airflow	Settings > Inputs > Proof of Airflow
Aux Digital Purge Position or Pilot Position	Settings > Inputs > Aux 1 or Aux 2

## 5.7 PROVEN PRE-PURGE STATE

The Proven Pre-Purge state is a running state that does not admit fuel to the burner. The system will energize the Fan output, prove airflow and hold for the user configured **Pre-Purge** Time to ensure that it is safe to proceed with burner ignition.

The Proven Pre-Purge state consists of the following sub states. Each of which are annunciated separately in the UI Status Bar:

1. Request Purge Position
2. Prove Airflow
3. Pre-Purge
4. Request Pilot Position

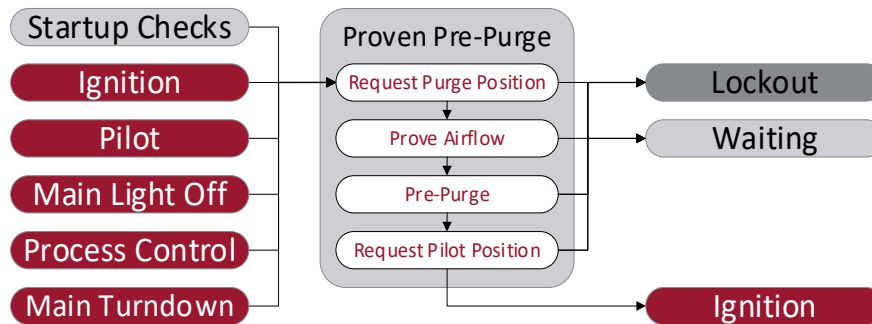

### 5.7.1 POWERED OUTPUT BEHAVIOR IN THE PROVEN PRE-PURGE STATE

Output	Request Purge Position	Prove Airflow	Pre-Purge	Request Pilot Position
Fan Output	Energized	Energized	Energized	Energized <sup>1</sup>
TCV Output	Purge Position			Pilot Position
Coil 1 Output				De-energized
Coil 2 Output				De-energized
Pilot 1 Valve Output				De-energized
Pilot 2 Valve Output				De-energized
Main SSV Outputs				De-energized

<sup>1</sup> Fan output is de-energized when **Fan Mode** is set to **Purge Only**

### 5.7.2 TRANSITIONS TO THE PROVEN PRE-PURGE STATE

From	Scenario	Condition
Startup Checks	Any	All startup checks successful
Ignition	Pilot fails to ignite	Ignition attempt limit not yet exceeded
Pilot	Flame failure	<b>Relight attempts</b> limit not yet exceeded
Process Control	Reignition command issued by the user	Any
Main Light Off	Flame failure	<b>Relight attempts</b> limit not yet exceeded
	Reignition command issued by the user	Any
	Process Temperature is too high	<b>Pilot Off Mode</b> is set to <b>Interrupted</b>
Main Turndown	Main Permissive condition is present	<b>Pilot Off Mode</b> is set to <b>Interrupted</b>
	Flame failure	<b>Relight attempts</b> limit not yet exceeded
	Reignition command issued by the user	Any
	Main Turndown complete	<b>Pilot Off Mode</b> is set to <b>Interrupted</b>

**5.7.3 TRANSITIONS WITHIN THE PROVEN PRE-PURGE STATE**

From	To	Scenario	Condition
Request Purge Position	Prove Airflow	Proof of purge position input is satisfied	PoP/Aux input configured for purge position proving
		<b>Purge Position Timeout</b> has elapsed	PoP/Aux input is not configured for purge position proving
Prove Airflow	Pre-Purge	Proof of Airflow input has been satisfied	<b>Airflow Proving Timeout</b> has not elapsed
Pre-Purge	Request Pilot Position	<b>Pre-Purge</b> time has elapsed	Any

**5.7.4 TRANSITIONS FROM THE PROVEN PRE-PURGE STATE**

To	Scenario	Condition
Lockout	Any	Alarm condition present
	System stopped by user	Any
	Failed to prove purge position	PoP/Aux input configured for purge position proving AND <b>Purge Position Timeout</b> has elapsed
	Failed to prove airflow	Any
Waiting Ignition	Failed to prove pilot position	PoP/Aux input configured for pilot position proving
	Any	Wait condition is present
	All Proven Pre-Purge sub states have been satisfied AND Proof of pilot position input is satisfied	PoP/Aux input configured for pilot position proving
	All Proven Pre-Purge sub states have been satisfied AND <b>Pilot Position Timeout</b> has elapsed	PoP/Aux input is not configured for pilot position proving

**5.7.5 RELATED SETTINGS – PROVEN PRE-PURGE STATE**

Setting	Navigation
Purge Position	Settings > Outputs > TCV
Pilot Position	Settings > Outputs > TCV
Pilot Position Timeout	Settings > Proc Control > Timing
Purge Position Timeout	Settings > Proc Control > Timing
Pre-Purge Time	Settings > Proc Control > Timing
Airflow Proving Timeout	Settings > Proc Control > Timing
Relight Attempts	Settings > Proc Control > Ignition
Pilot Off Mode	Settings > Proc Control > Configuration
Reignition	Settings > Proc Control > Configuration

## 5.8 IGNITION STATE

The Ignition state is the first fuel state in the burner startup sequence. The coil output(s) are energized, then the pilot valve output(s) are energized to attempt to light off the pilot burner(s). Successful pilot ignition is required before the burner can transition into any other fuel state.



### 5.8.1 POWERED OUTPUT BEHAVIOR IN THE IGNITION STATE

Output	Behavior
Coil 1 Output	Energized
Coil 2 Output	De-energized <sup>1</sup>
Pilot 1 Valve Output	Energized
Pilot 2 Valve Output	De-energized <sup>1</sup>
Main SSV Outputs	De-energized
Fan Output	Energized <sup>2</sup>
TCV Output	Pilot Position

<sup>1</sup> Energized when **Pilot 2** is **Enabled**

<sup>2</sup> Fan Output is de-energized when **Fan Mode** is set to **Purge Only**

If **Pilot 2** is **Enabled** and **Minimum Pilots Running** is set to **2**, successful pilot ignition requires flame to be established on both Pilot 1 and Pilot 2. If **Minimum Pilots Running** is set to **1**, successful pilot ignition requires flame to be established on one of Pilot 1 or Pilot 2 only.

### 5.8.2 TRANSITIONS TO THE IGNITION STATE

From	Scenario	Condition
Proven Pre-Purge	Any	Proven Pre-Purge sequence successful

### 5.8.3 TRANSITIONS FROM THE IGNITION STATE

To	Scenario	Condition
Lockout	Any	Alarm condition present
	System stopped by user	Any
	Pilot fails to ignite	Ignition attempt limit has been exceeded
Waiting	Any	Wait condition is present
Proven Pre-Purge	Pilot fails to ignite within the the declared <u>Pilot-Flame Establishing Period.</u>	Ignition attempt limit not yet exceeded
Pilot	Pilot ignition successful within the the declared <u>Pilot-Flame Establishing Period.</u>	Any

The **Relight Attempts** setting dictates only the number of relight attempts allowed following a flame-loss event. The system can attempt pilot ignition 3 times upon a fresh user start, regardless of the setting value.

### 5.8.4 RELATED SETTINGS - IGNITION STATE

Setting	Navigation
Relight Attempts	Settings > Proc Control > Ignition
Pilot 2	Settings > Proc Control > Configuration
Minimum Pilots Running	Settings > Proc Control > Configuration

## 5.9 PILOT STATE

The Pilot state ensures that a reliable pilot flame is established prior to lighting off the main burner. The system can remain in the pilot state when heat demand is low and will transition to a main state when the heat demand increases.

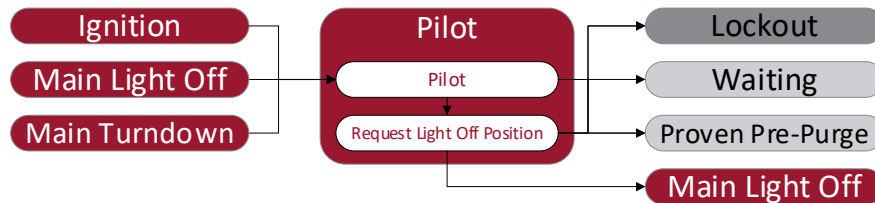

### 5.9.1 POWERED OUTPUT BEHAVIOR IN THE PILOT STATE

Output	Pilot	Request Light Off Position
TCV Output	Pilot Position	Light Off Position
Coil 1 Output		De-energized <sup>1</sup>
Coil 2 Output		De-energized <sup>1</sup>
Pilot 1 Valve Output		Energized <sup>2</sup>
Pilot 2 Valve Output		De-energized <sup>2 3</sup>
Main SSV Outputs		De-energized
Fan Output		Energized <sup>4</sup>

<sup>1</sup> Energized under Reignition conditions when **Reignition** setting is **Enabled**

<sup>2</sup> De-energized when single pilot flame is lost and **Pilot 2** is enabled and **Minimum Pilots Running** is **1**

<sup>3</sup> Energized when **Pilot 2** is **Enabled**

<sup>4</sup> Fan Output is de-energized when **Fan Mode** is set to **Purge Only**

### 5.9.2 TRANSITIONS TO THE PILOT STATE

From	Scenario	Condition
Ignition	Pilot ignition successful	Any
Main Light Off	Process Temperature is too high	<b>Pilot Off Mode</b> is not set to <b>Interrupted</b>
	Main Permissive condition present	<b>Pilot Off Mode</b> is not set to <b>Interrupted</b>
Main Turndown	Main Turndown Timer has elapsed	<b>Pilot Off Mode</b> is not set to <b>Interrupted</b>

After successful pilot flame establishment, the system will hold in the Pilot state for the duration of the user configured **Pilot Startup Delay** Time before it can transition to a main state. The Request Light Off Position sub-state allows for the TCV to move to its configured **Light Off Position** prior to entering the Main Light Off state. If the Proof of Position Input **Type** is **Disabled**, the system will hold in the Request Light Off Position sub-state for the duration of the configured **Light Off Position Timeout**. If the Proof of Position input **Type** is **Digital** or **4-20**, the system will transition out of the Request Light Off Position sub-state only once the Proof of Position input is satisfied. If it is not satisfied within the configured **Light Off Position Timeout**, the system will transition to the Lockout state.

5.9.3 TRANSITIONS FROM THE PILOT STATE

To	Scenario	Condition
Lockout	Any	Alarm condition present
	Burner stopped by user	Any
	Flame failure	<b>Relight attempts</b> limit has been exceeded
Waiting	Any	Wait condition present
Proven Pre-Purge	Flame failure	<b>Relight attempts</b> limit not yet exceeded
	Reignition command issued by the user	Any
Main Light Off	Process Temperature is too low	PoP <b>Type</b> is <b>Disabled</b> AND <b>Light Off Position Timeout</b> has elapsed
	Process Temperature is too low	PoP <b>Type</b> is not <b>Disabled</b> AND PoP input is satisfied

5.9.4 RELATED SETTINGS – PILOT STATE

Setting	Navigation
Relight Attempts	Settings > Proc Control > Ignition
Pilot Startup Delay	Settings > Proc Control > Timing
Pilot Off Mode	Settings > Proc Control > Configuration
Pilot 2	Settings > Proc Control > Configuration
Minimum Pilots Running	Settings > Proc Control > Configuration
Reignition	Settings > Proc Control > Configuration



## 5.10 MAIN LIGHT OFF STATE

The Main Light Off state allows for the controlled light off of the main burner before admitting maximum fuel to the burner. The main burner is lit with the TCV at its configured **Light Off Position** and is held there for the duration of the state to allow the burner to heat up gradually before transitioning into the Process Control state.

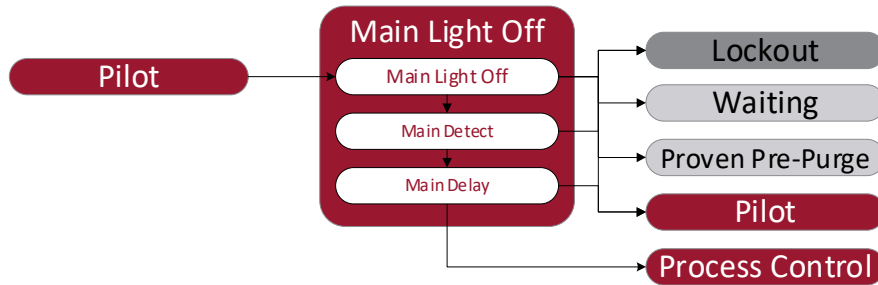

### 5.10.1 POWERED OUTPUT BEHAVIOR IN THE MAIN LIGHT OFF STATE

Output	Behavior
Coil 1 Output	De-energized <sup>1</sup>
Coil 2 Output	De-energized <sup>1</sup>
Pilot 1 Valve Output	Energized <sup>2</sup>
Pilot 2 Valve Output	De-energized <sup>2 3</sup>
Main SSV Outputs	Energized
Fan Output	Energized <sup>4</sup>
TCV Output	Light Off Position

<sup>1</sup> Energized under Reignition conditions when **Reignition** setting is **Enabled**

<sup>2</sup> De-energized following energization of Main SSV outputs when **Pilot Off Mode** is set to **Interrupted**

<sup>3</sup> Follows behavior of Pilot 1 Valve output when **Pilot 2** is **Enabled**

<sup>4</sup> Fan Output is de-energized when **Fan Mode** is set to **Purge Only**

### 5.10.2 TRANSITIONS TO THE MAIN LIGHT OFF STATE

From	Scenario	Condition
Pilot	Process Temperature is too low	No Main Permissive condition present

### 5.10.3 TRANSITIONS WITHIN THE MAIN LIGHT OFF STATE

From	To	Scenario	Condition
Main Light Off	Main Detect	Any	<b>UV Flame Detect Mode</b> is not <b>Disabled</b>
	Main Delay	Any	<b>UV Flame Detect Mode</b> is <b>Disabled</b>
Main Detect	Main Delay	Main flame established successfully	Any

When entering the Main Light Off state following a user start, the burner will hold the TCV at its configured **Light Off Position** in the Main delay sub-state for the duration of the user configurable **Main Startup Delay** before transitioning to the Process Control state. If the burner is re-entering the Main Light Off state after having previously been running in Process Control, the **Main Startup Delay Time** is ignored and the system holds in the Main Delay sub-state for 5 seconds before transitioning to the Process control state.

5.10.4 TRANSITIONS FROM THE MAIN LIGHT OFF STATE

To	Scenario	Condition
Lockout	Any	Alarm condition present
	System stopped by user	Any
	Flame failure	<b>Relight Attempts</b> limit has been exceeded
Waiting	Any	Wait condition present
Proven Pre-Purge	Flame failure	<b>Relight attempts</b> limit not yet exceeded
	Reignition command issued by the user	Any
	Process Temperature is too high	<b>Pilot Off Mode</b> is set to <b>Interrupted</b>
	Main Permissive condition is present	<b>Pilot Off Mode</b> is set to <b>Interrupted</b>
Pilot	Process Temperature is too high	<b>Pilot Off Mode</b> is not set to <b>Interrupted</b>
	Main Permissive condition is present	<b>Pilot Off Mode</b> is not set to <b>Interrupted</b>
Process Control	Main Delay sub-state has completed	Any

5.10.5 RELATED SETTINGS – MAIN LIGHT OFF STATE

Setting	Navigation
Relight Attempts	Settings > Proc Control > Ignition
Light Off Position Timeout	Settings > Proc Control > Timing
Main Startup Delay	Settings > Proc Control > Timing
Pilot Off Mode	Settings > Proc Control > Configuration
UV Flame Detect Mode	Settings > Proc Control > Configuration

## 5.11 PROCESS CONTROL STATE

The Process Control state is the state to which the system transitions when its heat demand is the highest. The Process Control state is annunciated as either PID Control or External Firing Rate in the UI Status Bar when **Process Control Mode** is set to **PID Control** or **External Firing Rate**, respectively.



### 5.11.1 POWERED OUTPUT BEHAVIOR IN THE PROCESS CONTROL STATE

Output	Behavior
Coil 1 Output	De-energized <sup>1</sup>
Coil 2 Output	De-energized <sup>1</sup>
Pilot 1 Valve Output	Energized <sup>2</sup>
Pilot 2 Valve Output	De-energized <sup>2 3</sup>
Main SSV Outputs	Energized
Fan Output	Energized <sup>4</sup>
TCV Output	Modulated to maintain Process Temperature setpoint <sup>5</sup>

<sup>1</sup> Energized under Reignition conditions when **Reignition** setting is **Enabled**

<sup>2</sup> De-energized when **Pilot Off Mode** is set to **Interrupted**

<sup>3</sup> Follows behavior of Pilot 1 Valve output when **Pilot 2** is **Enabled**

<sup>4</sup> Fan Output is de-energized when **Fan Mode** is set to **Purge Only**

<sup>5</sup> TCV output ignores Process Temperature setpoint and echoes External Firing Rate input when **Process Control Mode** is set to **External Firing Rate**

### 5.11.2 TRANSITIONS TO THE PROCESS CONTROL STATE

From	Scenario	Condition
Main Light Off	Main Delay sub-state has completed	Any

### 5.11.3 TRANSITIONS FROM THE PROCESS CONTROL STATE

To	Scenario	Condition
Lockout	Any	Alarm condition present
	System stopped by user	Any
	Flame failure	<b>Relight Attempts</b> limit has been exceeded
Proven Pre-Purge	Flame failure	<b>Relight attempts</b> limit not yet exceeded
	Reignition command issued by the user	Any
Main Turndown	Any	Wait condition is present
	Any	Main permissive condition is present
	Process Temperature is too high	Any

### 5.11.4 RELATED SETTINGS – PROCESS CONTROL STATE

Setting	Navigation
Relight Attempts	Settings > Proc Control > Ignition
Process Control Mode	Settings > Proc Control > Configuration
Pilot Off Mode	Settings > Proc Control > Configuration
Reignition	Settings > Proc Control > Configuration
PID Parameters	Settings > Proc Control > PID Control
TCV Minimum Position	Settings > Outputs > TCV
Aux Firing Rate Settings	Setting > Inputs > Aux 1 or Aux 2

## 5.12 MAIN TURNDOWN STATE

The Main Turndown state allows for the system to reliably transition from the Process Control state to a lower heat demand state. The firing rate output (and thus mechanically linked air damper output) decreases slowly to allow the airflow volume to reduce to a stable pilot operating level before de-energizing the main valves.



### 5.12.1 POWERED OUTPUT BEHAVIOR IN THE MAIN TURNDOWN STATE

Output	Behavior
Coil 1 Output	De-energized <sup>1</sup>
Coil 2 Output	De-energized <sup>1</sup>
Pilot 1 Valve Output	Energized <sup>2</sup>
Pilot 2 Valve Output	De-energized <sup>2 3</sup>
Main SSV Outputs	Energized
Fan Output	Energized <sup>4</sup>
TCV Output	Light Off Position

<sup>1</sup> Energized under Reignition conditions when **Reignition** setting is **Enabled**

<sup>2</sup> De-energized following energization of Main SSV outputs when **Pilot Off Mode** is set to **Interrupted**

<sup>3</sup> Follows behavior of Pilot 1 Valve output when **Pilot 2** is **Enabled**

<sup>4</sup> Fan Output is de-energized when **Fan Mode** is set to **Purge Only**

### 5.12.2 TRANSITIONS TO THE MAIN TURNDOWN STATE

From	Scenario	Condition
Process Control	Any	Wait condition is present
	Any	Main permissive condition is present
	Process Temperature is too high	Any

### 5.12.3 TRANSITIONS FROM THE MAIN TURNDOWN STATE

To	Scenario	Condition
Lockout	Any	Alarm condition present
	System stopped by user	Any
	Flame failure	<b>Relight Attempts</b> limit has been exceeded
Waiting	Main Turndown complete	Wait condition present
Proven Pre-Purge	Flame failure	<b>Relight attempts</b> limit not yet exceeded
	Reignition command issued by the user	Any
	Main Turndown complete	<b>Pilot Off Mode</b> is set to <b>Interrupted</b>
Pilot	Main Turndown complete	<b>Pilot Off Mode</b> is not set to <b>Interrupted</b>

### 5.12.4 RELATED SETTINGS – MAIN TURNDOWN STATE

Setting	Navigation
Light Off Position	Settings > Outputs > TCV
Pilot Off Mode	Settings > Proc Control > Configuration
Relight Attempts	Settings > Proc Control > Ignition

## 6 INSTALLATION



Warning: Installation and modification shall not be performed while the system is energized. Disconnect power source prior to connecting devices or modifying wiring.

Installers and commissioners of the PF2200-FD system must:

- Understand local codes and how they apply to the installation (for both electrical and mechanical aspects of the installation).
- Understand the electrical and mechanical limitations of the product and how that relates to the installation.
- Understand the safety and operational effects of modifying system settings or wiring.
- Verify all required safety functions prior to completing the commissioning of the appliance.
- Be fluent in the English language (the only language this product supports).
- Be familiar with navigating the product menus and modifying settings.

### 6.1 MOUNTING CONSIDERATIONS

The enclosure should be mounted:

- Upright in such a way that the screen is clearly visible and the keypad is easy to access. Recommended mounting height is 1.5m (5ft) above ground.
- Near to the appliance being controlled in order to minimize cable run lengths to the valve train (solenoids), burner assembly (ignition coil and flame rod) and thermocouple elements.
- In such a way as to avoid direct sunlight exposure on the screen. Extended UV exposure may compromise viewability.
- Such that the enclosure door can be fully opened during maintenance and commissioning.

## 6.2 CONNECTION DIAGRAMS



Caution: Electrical devices connected to the controller must meet local electrical codes and be within the voltage limits specified in this manual.



Caution: All field wiring must be properly fused and sized in accordance with local codes.



Caution: Wires must be installed such that the connection does not rely on the structural integrity of the wire insulation, and that no more than one conductor is terminated in a single terminal.

### 6.2.1 DIGITAL INPUT - DRY CONTACT

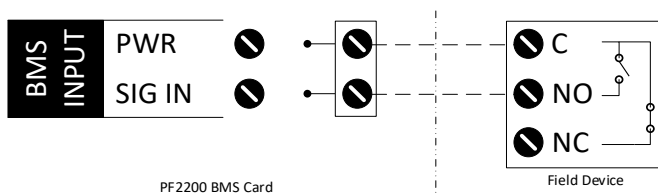

Installation Notes:

1. The BMS uses energized-to-run logic for all digital inputs.
2. PWR terminal output matches system voltage up to 13.5V.

### 6.2.2 DIGITAL INPUT - WET CONTACT

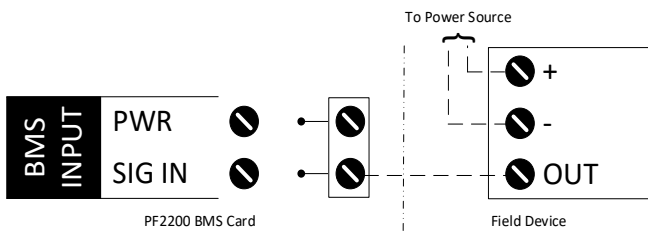

Installation Notes:

1. The BMS uses energized-to-run logic for all digital inputs.
2. External power source must be Earth grounded.
3. External power source must be referenced about BMS card terminal 29 such that the supplied voltage (1) does not exceed  $30V_{DC}$  with reference to BMS Power In -, and (2) does not drop below -0.5V with reference to BMS Power In -.

### 6.2.3 ANALOG INPUT - LOOP POWERED 4-20mA TRANSMITTER

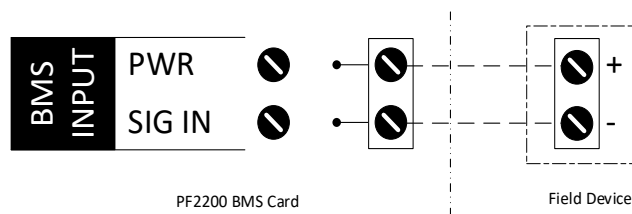

Installation Notes:

1. PWR terminal output matches system voltage up to 13.5V.

6.2.4 ANALOG INPUT – SELF POWERED 4-20mA TRANSMITTER

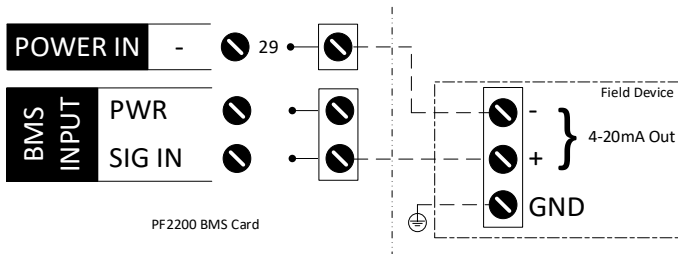

Installation Notes:

1. Field Device must be Earth grounded.
2. Power source must be referenced about BMS card terminal 29 such that the supplied voltage (1) does not exceed 30V<sub>DC</sub> with reference to BMS Power In -, and (2) does not drop below -0.5V with reference to BMS Power In -.

6.2.5 ANALOG INPUT – INPUT FROM PLC

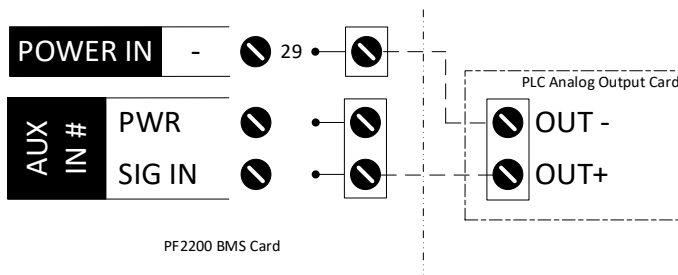

Installation Notes:

1. PLC power source must be referenced about BMS card terminal 29 such that the supplied voltage (1) does not exceed 30V<sub>DC</sub> with reference to BMS Power In -, and (2) does not drop below -0.5V with reference to BMS Power In -.

6.2.6 TCV OUTPUT WIRING

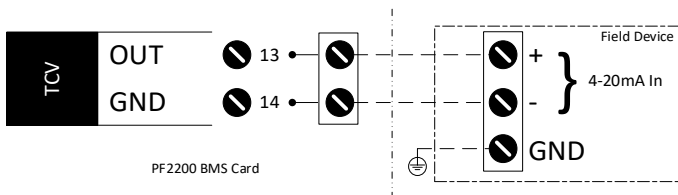

Installation Notes:

1. 4-20mA Input - terminal must be run back to BMS terminal 14 (Local ground) to ensure proper output functionality.

6.2.7 SOLENOID OUTPUT – 12V/24V

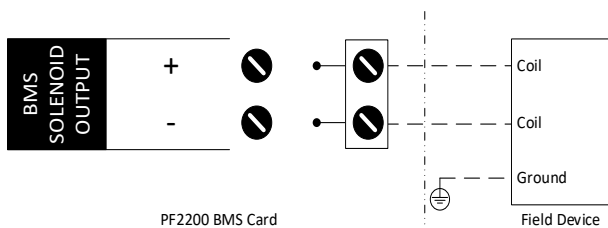

Installation Notes:

1. Solenoid powered outputs are rated to 5A max individually, however the power input to the BMS is fused at 10A. Care must be taken as to not exceed the 10A max input when using multiple high-powered solenoids.
2. Solenoid valve outputs are assumed to be in safe state when de-energized. Normally closed valves must be used such that gas-flow to the burner is stopped when the output is in the de-energized state. Solenoid valve outputs can also be connected to normally open bleed valves when utilizing a double block and bleed configuration.





Caution: Do not connect solenoid device minus (-) terminals to ground, as the BMS solenoid output minus (-) terminals are not grounded.

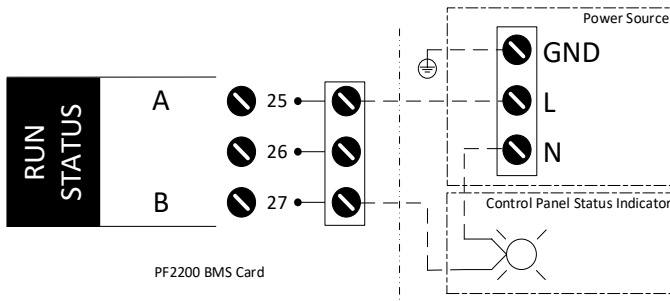

Caution: Do not jumper solenoid minus terminals together under any circumstance, as this will compromise the safety integrity of the system.

**6.2.8 RUN STATUS – EXTERNAL AC SOURCE**





Warning: 120VAC wiring should be installed by a qualified electrician.

**6.2.9 RUN STATUS – EXTERNAL DC SOURCE**

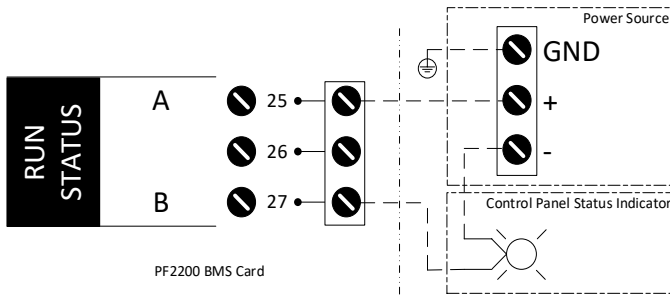

**6.2.10 RUN STATUS – BMS POWER**

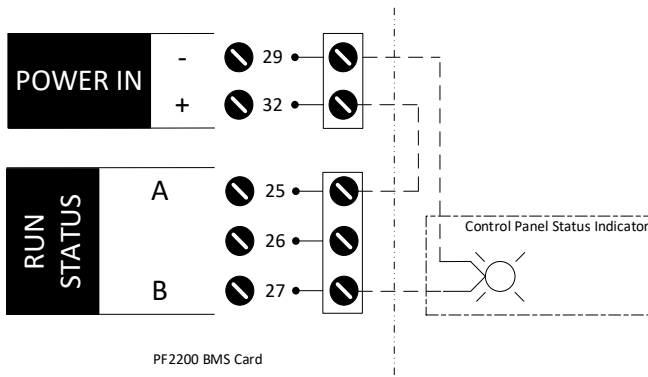



6.2.11 RUN STATUS – PUMP CONTROL

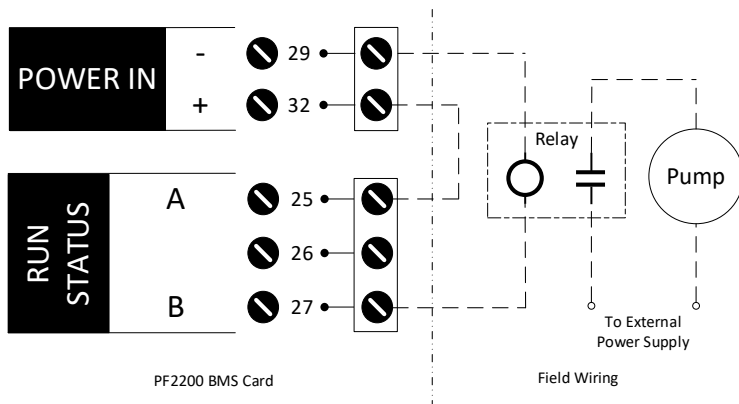

Installation Notes:

1. A relay must be used to isolate the Run Status contact from high-transient currents associated with motors and pumps.



Warning: 120VAC wiring should be installed by a qualified electrician.

6.2.12 POWER INPUT WIRING

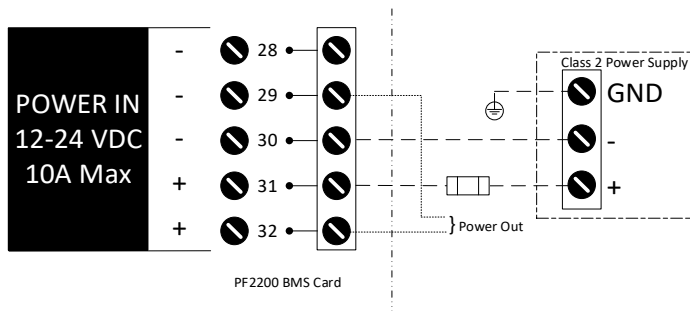

6.2.13 ANALOG OUTPUT – 4-20mA ECHO TO PLC

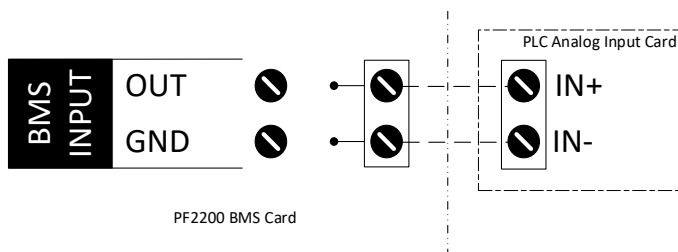

Installation Notes:

1. 4-20mA Input IN- terminal must be run back to BMS Input GND terminal (Local ground) to ensure proper output functionality.

### 6.2.14 SINGLE ROD IGNITION WIRING

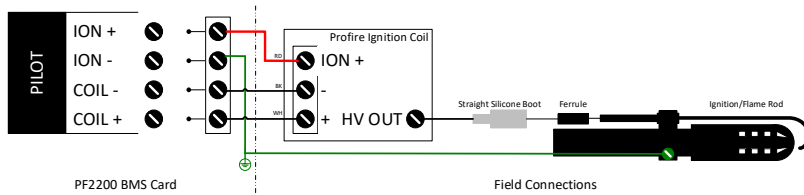

Installation Notes:

1. The wire length between the ignition coil and pilot should be no more than 5m (15ft).
2. For long run lengths connect burner housing to ION - terminal with ignition cable to avoid ground-loading



Warning: Failure to provide a low-impedance path from the burner assembly to the PF2200 may result in electric shock, product damage, failure to ignite the pilot, or failure to detect flame.

### 6.2.15 DUAL ROD IGNITION WIRING

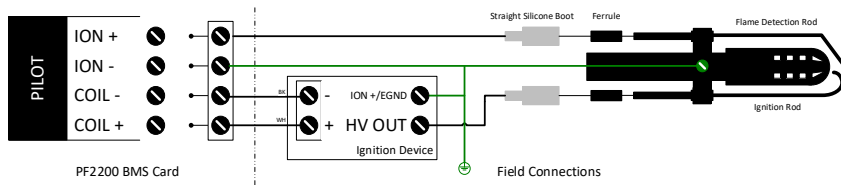

Installation Notes:

1. The wire length between the ignition coil and pilot should be no more than 5m (15ft).
2. For long run lengths connect burner housing to ION - terminal with ignition cable to avoid ground-loading



Warning: Failure to provide a low-impedance path from the burner assembly to the PF2200 may result in electric shock, product damage, failure to ignite the pilot, or failure to detect flame.

### 6.2.16 TEMPERATURE INPUT- DUAL TYPE K THERMOCOUPLE

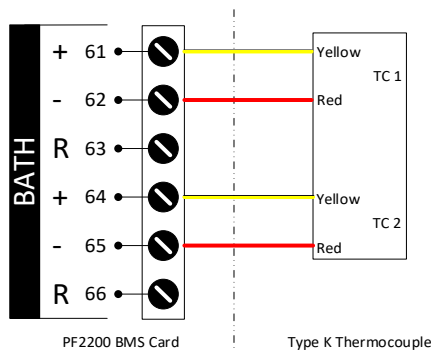

Installation Notes:

1. Thermocouple must be grounded or ungrounded Type K.
2. Thermocouple wire run lengths should be minimized where possible.
3. Thermocouple wires should not be run in the same conduit as high-noise signals (e.g. valve wires, motor wires, etc.)

### 6.2.17 TEMPERATURE INPUT- DUAL 3-WIRE RTD

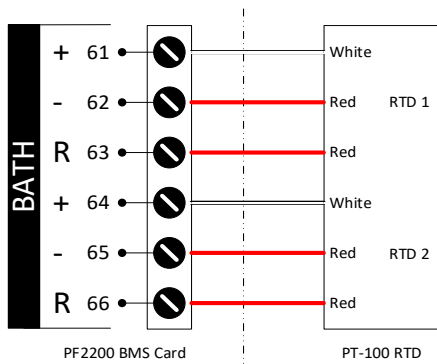

### 6.2.18 TEMPERATURE INPUT- SINGLE TYPE K THERMOCOUPLE

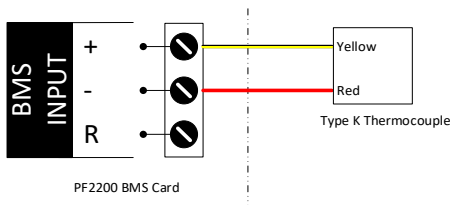

Installation Notes:

1. Thermocouple must be grounded or ungrounded Type K.
2. Thermocouple wire run lengths should be minimized where possible.
3. Thermocouple wires should not be run in the same conduit as high-noise signals (e.g. valve wires, motor wires, etc.)

### 6.2.19 TEMPERATURE INPUT- SINGLE 3-WIRE RTD

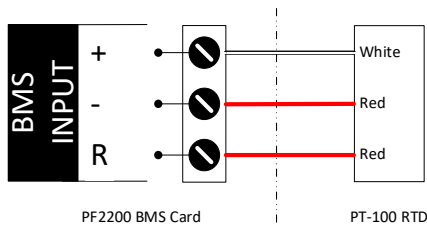

### 6.2.20 MODBUS INPUT WIRING

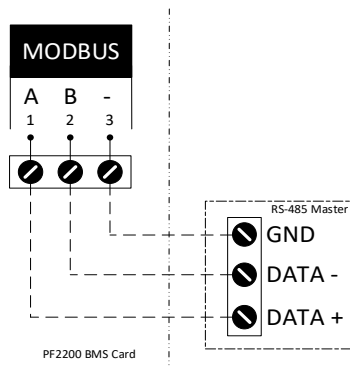

Installation Notes:

1. Modbus wires should not be run in the same conduit as high-noise signals (e.g. valve wires, motor wires, etc.)

6.2.21 UV FLAME SCANNER WIRING

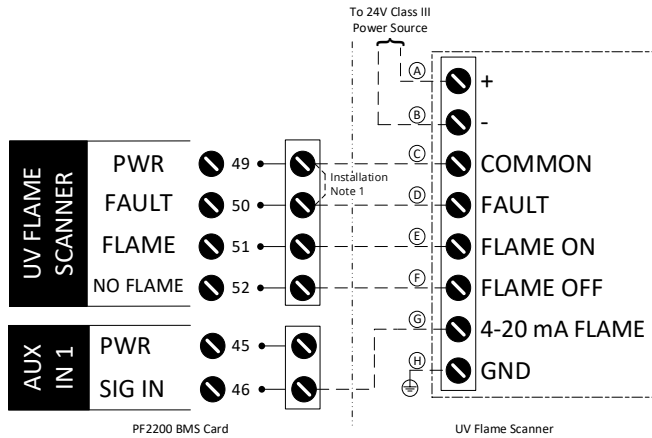

Wire Colors for approved UV Flame Scanners:

Wire	Fireye 65UV5-1004E	Zeeco ZPF-120
A	Brown	Red
B	White	Blue
C	Blue	Brown
D	Black	N/A
E	Yellow	Green
F	Red	White
G	Orange	Pink
H	Green	Grey

Installation Notes:

1. When using Zeeco ZPF-120 flame scanner, a wire jumper must be installed between BMS terminals 49 and 50, as the scanner does not have a separate fault output.

6.2.22 FAN OUTPUT WIRING

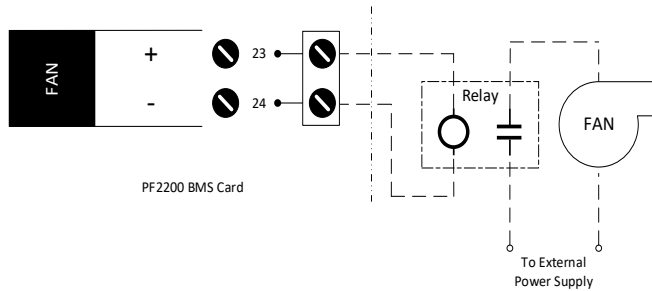

# 7 SYSTEM CONFIGURATION

The following section describes each configuration setting found in the menus of the PF2200-FD. All settings changes must be verified prior to starting the system and functional tests must be performed to ensure that all expected alerts ring in correctly. The best way to verify the system configuration is to manually force an alarm condition on each connected input or output device independently and verify that the PF2200 annunciates the appropriate alarm.



Warning: System settings must only be modified by qualified personnel who have an understanding of the appliance under control and its effect on the other plant processes.

## 7.1 TEMPERATURES

### 7.1.1 BATH INPUT

Name	Default	Options / Range	Description
<b>Type</b>	RTD	TC RTD	Temperature sensing element type. Type K Thermocouple (grounded or ungrounded) or PT100 RTD.
<b>Input</b>	Dual	Dual Single	Configuration control for the Bath input. Dual requires two unique temperature sensing elements, whereas single only requires one.
Input setting is required to be set to Dual if the Bath Input is specified as a safety function.			
<b>Mode</b>	Process Control	Process Control High Temp ESD	Mode for the temperature input, used by the system to determine how the input is to be used.
At least one of Bath Mode or Outlet Mode must be set to Process Control			
<b>High Temp Setpoint</b>	90 °C 194 °F	0 °C - 1350 °C 32 °F - 2462 °F	Temperature threshold at which the system shuts down.
High Temp Setpoint must be greater than Pilot Off Setpoint and If Type setting is set to RTD, High Temp Setpoint must be less than 850 °C (1562 °F)			
<b>Pilot Off Setpoint</b>	85 °C 185 °F	0 °C - 1350 °C 32 °F - 2462 °F	Temperature threshold at which the system turns off the pilot valve(s).
Pilot Off Setpoint must be greater than Main Off Setpoint and less than High Temp Setpoint			
<b>Main Off Setpoint</b>	85 °C 185 °F	0 °C - 1350 °C 32 °F - 2462 °F	Temperature threshold at which the system turns off the main valve(s).
Main Off Setpoint must be greater than Process Setpoint and less than Pilot Off Setpoint			
<b>Process Setpoint</b>	80 °C 176 °F	0 °C - 1350 °C 32 °F - 2462 °F	Temperature that the system attempts to maintain when in Process Control mode.
Process Setpoint must be greater than Low Temp Setpoint and less than Main Off Setpoint			
<b>Low Temp Setpoint</b>	0 °C 32 °F	0 °C - 1350 °C 32 °F - 2462 °F	Temperature threshold at which, if not exceeded, the system warns the user.
Low Temp Setpoint must be less than Process Setpoint			
<b>Deadband</b>	2 °C 3.6 °F	0 °C - 100 °C 0 °F - 180 °F	The deadband prevents bouncing between states when the input reading is close to the corresponding setpoint.

**7.1.2 OUTLET INPUT**

<b>Name</b>	<b>Default</b>	<b>Options / Range</b>	<b>Description</b>
<b>Type</b>	RTD	TC RTD	Temperature sensing element type. Can be Type K Thermocouple (grounded or ungrounded) or PT100 RTD.
<b>Mode</b>	Disabled	Disabled Process Control High Temp ESD Display Only	Mode for the temperature input, used by the system to determine how the input is to be used. See Temperature Inputs section for more details.
At least one of Bath Mode or Outlet Mode must be set to Process Control			
<b>High Temp Setpoint</b>	90 °C 194 °F	0 °C - 1350 °C 32 °F - 2462 °F	Temperature threshold at which, if exceeded, the system will shut down.
Only applicable if the mode is set to High Temp ESD or Process Control. High Temp must be greater than Pilot Off Setpoint AND If Type is RTD, must be less than 850 °C (1562 °F)			
<b>Pilot Off Setpoint</b>	85 °C 185 °F	0 °C - 1350 °C 32 °F - 2462 °F	Temperature threshold at which the system will turn off the pilot valve(s).
Pilot Off Setpoint must be greater than Main Off Setpoint and less than High Temp Setpoint			
<b>Main Off Setpoint</b>	85 °C 185 °F	0 °C - 1350 °C 32 °F - 2462 °F	Temperature threshold at which the system will turn off the main valve(s).
Main Off Setpoint must be greater than Process Setpoint and less than Pilot Off Setpoint			
<b>Process Setpoint</b>	80 °C 176 °F	0 °C - 1350 °C 32 °F - 2462 °F	Temperature that the system attempts to maintain when in Process Control mode.
Process Setpoint must be greater than Low Temp Setpoint and less than Main Off Setpoint			
<b>Low Temp Setpoint</b>	0 °C 32 °F	0 °C - 1350 °C 32 °F - 2462 °F	Temperature threshold at which, if not exceeded, the system will warn the user.
Low Temp Setpoint must be less than Process Setpoint			
<b>Deadband</b>	2 °C 3.6 °F	0 °C - 100 °C 0 °F - 180 °F	The deadband prevents bouncing between states when the input reading is close to the corresponding setpoint.

**7.1.3 STACK INPUT**

<b>Name</b>	<b>Default</b>	<b>Options / Range</b>	<b>Description</b>
<b>Type</b>	RTD	TC RTD	Temperature sensing element type. Can be Type K Thermocouple (grounded or ungrounded) or PT100 RTD.
<b>Mode</b>	Disabled	Disabled High Temp ESD Display Only	Mode for the temperature input, used by the system to determine how the input is to be used.
<b>High Temp Setpoint</b>	90 °C 194 °F	0 °C - 1350 °C 32 °F - 2462 °F	Temperature threshold at which the system will shut down.
Only applicable if the mode is set to High Temp ESD If Type is RTD, High Temp Setpoint must be less than 850 °C (1562°F)			
<b>Deadband</b>	2 °C 3.6 °F	0 °C - 100 °C 0 °F - 180 °F	The deadband prevents bouncing between states when the input reading is close to the corresponding setpoint.

## 7.2 INPUTS

### 7.2.1 LEVEL/FLOW INPUT

Name	Default	Options / Range	Description
<b>Type</b>	Digital	Disabled Digital 4-20	Level/Flow sensor type. Can be configured as a switch (digital), transmitter (4-20), or disabled.
<b>Digital Mode</b>	Alarm	Alarm Wait Warning	Action the system will take when a de-energized contact occurs.
Type must be set to Digital			
<b>4-20 Low Trip Mode</b>	Alarm	Alarm Wait Warning	Action the system will take when a low-trip event occurs.
Type must be set to 4-20			
<b>4-20 High Trip Mode</b>	Alarm	Alarm Wait Warning	Action the system will take when a high-trip event occurs.
Type must be set to 4-20			
<b>4-20 Low Trip Setpoint</b>	60 L 15.9 gal	Span Min to Max	Input threshold at which the system will initiate a low-trip event in accordance with the 4-20 Low Trip Mode setting.
Type must be set to 4-20			
<b>4-20 High Trip Setpoint</b>	117 L 30.9 gal	Span Min to Max	Input threshold at which the system will initiate a high-trip event in accordance with the 4-20 High Trip Mode setting.
Type must be set to 4-20			
<b>4-20 Deadband</b>	1.5 L 0.4 gal	0 - 6.25% of span	The deadband prevents bouncing between states when the input reading is close to the corresponding trip point.
To clear a low trip, input must be greater than 4-20 Low Trip plus deadband.			
To clear a high trip, input must be less than 4-20 High Trip minus deadband.			
<b>4-20 Span Min</b>	0 L 0 gal	0 - 10000000 L 0 - 2641720 gal	Level/Flow value corresponding to 4mA output from the 4-20mA transmitter.
Span Min must be less than Span Max and 4-20 Low Trip			
<b>4-20 Span Max</b>	120 L 31.7 gal	0 - 10000000 L 0 - 2641720 gal	Level/Flow value corresponding to 20mA output from the 4-20mA transmitter.
Span Max must be greater than Span Min and 4-20 High Trip			
<b>Level/Flow Delay</b>	2 sec	2 sec - 20 sec	The amount of time the system requires a low-input event be consistent for before performing the low-trip action.

7.2.2 PRESSURE INPUT

Name	Default	Options / Range	Description
<b>Type</b>	Digital	Disabled Digital 4-20	Pressure sensor type. Can be configured as a switch (digital), transmitter (4-20), or disabled.
<b>4-20 Low Trip</b>	0 kPa 0 psi	Span Min to Max	Input threshold at which the system will initiate a low-trip event in accordance with the Low Pressure Mode setting.
Type must be set to 4-20			
<b>4-20 High Trip</b>	177 kPa 25.7 psi	Span Min to Max	Pressure threshold that, if exceeded, the system will shutdown.
Type must be set to 4-20			
<b>4-20 Deadband</b>	2.6 kPa 0.4 psi	0 - 6.25% of span	The deadband prevents bouncing between states when the input reading is close to the corresponding trip point.
To clear a low trip, input must be greater than 4-20 Low Trip plus deadband.			
To clear a high trip, input must be less than 4-20 High Trip minus deadband.			
<b>4-20 Span Min</b>	0 kPa 0 psi	0 - 100000 kPa 0 psi - 14504 psi	Pressure value corresponding to 4mA output from the 4-20mA transmitter.
Span Min must be less than Span Max and 4-20 Low Trip			
<b>4-20 Span Max</b>	207 kPa 30 psi	0 - 100000 kPa 0 psi - 14504 psi	Pressure value corresponding to 20mA output from the 4-20mA transmitter.
Span Max must be greater than Span Min and 4-20 High Trip			
<b>Low Pressure Mode</b>	Alarm	Alarm Wait Warning Main Permissive	Action the system will take when a low-pressure event occurs.
<b>Low Pressure Delay</b>	2 sec	2 sec - 20 sec	The amount of time a low-pressure condition must be present before the system takes any action.

7.2.3 PRESSURE HIGH INPUT

Name	Default	Options / Range	Description
<b>Pressure High</b>	Enabled	Disabled Enabled	See High Pressure Input section for more details.



**7.2.4 AUX IN 1 & AUX IN 2 INPUTS**

<b>Name</b>	<b>Default</b>	<b>Options / Range</b>	<b>Description</b>
<b>Type</b>	Digital	Disabled Digital 4-20	Input sensor type. Can be configured as a switch (digital), transmitter (4-20), or disabled.
<b>4-20 Mode</b>	High/Low Trip	High/Low Trip Appliance Firing Rate Bath Process SP Adjust Outlet Process SP Adjust UV Flame Quality	Various modes for the Aux input when configured as a 4-20 type. See Auxiliary Inputs section for more details.
Type must be set to 4-20			
<b>Digital Mode</b>	Alarm	Alarm Wait Warning Main Permissive Pilot Position Purge Position	Defines the system behavior when a de-energized contact occurs.
Type must be set to Digital			
<b>4-20 Low Trip Mode</b>	Alarm	Alarm Wait Warning Main Permissive	Action the system will take when a low-trip event occurs.
Type must be set to 4-20			
<b>4-20 High Trip Mode</b>	Alarm	Alarm Wait Warning Main Permissive	Action the system will take when a high-trip event occurs.
Type must be set to 4-20			
<b>4-20 Low Trip</b>	0%	0 - 100%	Input threshold at which the system will initiate a low-trip event in accordance with the 4-20 Low Trip Mode setting.
Type must be set to 4-20			
<b>4-20 High Trip</b>	100%	0 - 100%	Input threshold at which the system will initiate a high-trip event in accordance with the 4-20 High Trip Mode setting.
Type must be set to 4-20			
<b>4-20 Deadband</b>	1.2%	0 - 6.2%	The deadband prevents the system from bouncing between states when the input reading is close to the corresponding trip point.
Type must be set to 4-20			
To clear a low trip, input must be greater than 4-20 Low Trip plus deadband.			
To clear a high trip, input must be less than 4-20 High Trip minus deadband.			
<b>4-20 Span Min</b>	0%	0% - 100%	Input value corresponding to 4mA output from the 4-20mA transmitter.
Type must be set to 4-20			
Span Max must be greater than Span Min			
<b>4-20 Span Max</b>	100%	0% - 100%	Input value corresponding to 20mA output from the 4-20mA transmitter.
Type must be set to 4-20			
Span Max must be greater than Span Min			

**7.2.5 PROOF OF POSITION INPUT**

<b>Name</b>	<b>Default</b>	<b>Options / Range</b>	<b>Description</b>
<b>Type</b>	Disabled	Disabled Digital (POLO) 4-20	Position input device type.
<b>Tolerance</b>	2.0%	0 - 100%	Allowable position error tolerance of the Position Input device.

Type must be set to 4-20

**7.2.6 PROOF OF AIRFLOW INPUT**

<b>Name</b>	<b>Default</b>	<b>Options / Range</b>	<b>Description</b>
<b>Type</b>	Digital	Digital 4-20	Airflow sensor type
<b>Low Trip Setpoint</b>	60 CFM	Span Min to Max	Input threshold at which the system will initiate a low-trip event
<b>High Trip Setpoint</b>	120 CFM	Span Min to Max	Input threshold at which the system will initiate a high-trip event
<b>Deadband</b>	1.5 CFM	0 - 6.25% of span	The deadband prevents bouncing between states when the input reading is close to the corresponding trip point.
<b>Span Min</b>	0 CFM	0 - 100000 CFM	Airflow value corresponding to 4mA output from the 4-20mA transmitter.
<b>Span Max</b>	120 CFM	0 - 100000 CFM	Airflow value corresponding to 20mA output from the 4-20mA transmitter.

**7.2.7 PROOF OF CLOSURE INPUT**

<b>Name</b>	<b>Default</b>	<b>Options / Range</b>	<b>Description</b>
<b>Proof of Closure</b>	Enabled	Disabled Enabled	Controls whether the Proof of Closure input is enabled or disabled. See Proof of Closure Input section for details.

**7.2.8 REMOTE START INPUT**

<b>Name</b>	<b>Default</b>	<b>Options / Range</b>	<b>Description</b>
<b>Remote Start</b>	Disabled	Disabled Enabled	Controls whether the Remote Start input is enabled or disabled. See Remote Start Input section for more details.

## 7.3 PROCESS CONTROL

### 7.3.1 CONFIGURATION

Name	Default	Options / Range	Description
<b>Process Control Mode</b>	Bath PID Control	External Firing Rate Bath PID Control Outlet PID Control Cascaded PID Control	Control mode of the system.
<b>Post Purge Mode</b>	Purge Position	Purge Position Last Position	Defines the TCV position when post purging
<b>Pilot Off Mode</b>	Disabled	Disabled Off at Pilot Off Setpoint Off at Main Off Setpoint Interrupted	Defines when the system turns off the Pilot valve while running:
When set to Interrupted – UV Flame Detect must be set to Main Only OR Pilot and Main			
<b>Pilot 2</b>	Disabled	Disabled Enabled	Enables the second Pilot valve output and flame detection input.
When Enabled – UV Flame Detect Mode must be set to Disabled OR Main Only			
<b>Minimum Pilots Running</b>	1	1 - 2	Specifies the number of pilots that must be lit for the system to remain running.
When set to 2 – Pilot 2 must be enabled			
<b>Reignition</b>	Disabled	Disabled Enabled	Specifies whether the system will automatically attempt to reignite a lost pilot flame.
Pilot 2 must be enabled Minimum Pilots Running must be set to 1			
<b>UV Flame Detect Mode</b>	Disabled	Disabled Main Only Pilot and Main	Specifies where UV flame detection will be used.

### 7.3.2 TIMING

Name	Default	Options / Range	Description
<b>Pilot Position Timeout</b>	60 sec	5 sec – 900 sec	Time allowed for TCV to reach its configured Pilot position
<b>Light Off Position Timeout</b>	60 sec	5 sec – 900 sec	Time allowed for TCV to reach its configured Light Off position
<b>Purge Position Timeout</b>	60 sec	5 sec – 900 sec	Time allowed for TCV to reach its configured Purge position
<b>Pre-Purge Time</b>	60 sec	10 sec – 900 sec	Time that the system will remain in the Pre-Purge state.
<b>Post-Purge Time</b>	60 sec	10 sec – 900 sec	Time that the system will Post-Purge for
<b>Startup Check Timeout</b>	60 sec	5 sec – 900 sec	Time allowed for the system to complete its startup checks
<b>Airflow Proving Timeout</b>	60 sec	10 sec – 900 sec	Time allowed for airflow to be proven
<b>Pilot Startup Delay</b>	15 sec	5 sec – 900 sec	Time that the system will hold in the Pilot state before transitioning to a higher heat demand state
<b>Main Startup Delay</b>	30 sec	30 sec – 600 sec	Time that the system will hold in the TCV at its Light Off position before transitioning to the Process Control state

7.3.3 IGNITION

Name	Default	Options / Range	Description
Ignition Mode	Coil	Coil HEI	Controls the Coil output behavior when in the ignition state: Coil: Pulsed output mode HEI: constant output mode
Relight Attempts	3	0 - 3 attempts	Determines the number of relight attempts the system will use when establishing flame.

7.3.4 PID CONTROL

Name	Default	Options / Range	Description
Process Proportional Band	10 °C 18 °F	0 °C - 1000 °C 0 °F - 1800 °F	This is the proportional Band used for the PID calculation. In cascaded control mode this value applies to the bath PID loop.
Process Integral Time	4 mins/rep	0 - 1000 mins/rep	This is the integral time used for the PID calculation.
Process Derivative Time	0 min	0 min - 1000 min	This is the derivative time used for the PID calculation.
Process Integral Reset Range	10 °C 18 °F	0 °C - 1000 °C 0 °F - 1800 °F	Process temperature range in which the integral term will accumulate.
Cascade Proportional Band	10 °C 18 °F	0 °C - 1000 °C 0 °F - 1800 °F	Proportional Band setting for cascaded PID. Inputs > Process Control > Configuration > Process Control Mode must be set to Cascaded PID Control
Cascade Integral Time	0 mins/rep	0 mins/rep - 1000 mins/rep	Integral time setting for cascaded PID. Inputs > Process Control > Configuration > Process Control Mode must be set to Cascaded PID Control
Cascade Derivative Time	0 min	0 min - 1000 min	Derivative time setting for cascaded PID. Inputs > Process Control > Configuration > Process Control Mode must be set to Cascaded PID Control
Cascade Integral Reset Range	10 °C 18 °F	0 °C - 1000 °C 0 °F - 1800 °F	In cascaded mode this is the boundary of the integral windup range for the outlet temperature. If the outlet temperature is outside of this range the integral term will not accumulate.
Output Rate Limit	100 %/sec	0.1 - 100 %/sec	This is the limit for the maximum output change of the TCV per second. A larger value allows for a quicker change in output. A smaller value slows down any change in output. This can help prevent fast movements from the TCV.
Ramp Time	10 sec	0 sec - 255 sec	Once the system enters process control mode after light off delay it will slowly ramp to the requested firing rate over this time.

## 7.4 OUTPUTS

### 7.4.1 STATUS OUTPUT

Name	Default	Options / Range	Description
<b>Status Contact Mode</b>	Run Status	Run Status Heating Status Low Temp Warning Level/Flow Control	Defines the behavior of the Status Contact. See Status Relay Output section for more details.
<b>Level/Flow Control Setpoint</b>	18 mA	4mA – 20mA	Defines the Level/Flow setpoint at which the Status Contact changes state.

Status Contact Mode must be set to Level/Flow Control

### 7.4.2 VALVES / FAN OUTPUTS

Name	Default	Options / Range	Description
<b>Pilot Valve PWM</b>	60%	1 % - 100 %	Duty cycle of the output. Higher value corresponds to higher average output.
<b>SSV PWM</b>	60%	1 % - 100 %	Duty cycle of the output. Higher value corresponds to higher average output.
<b>Fan Mode</b>	Forced Draft	Forced Draft Purge Only	Type of device connected to the Fan output terminals



Warning: The **Purge Only** Fan output mode must not be used for applications which require fan-assisted combustion air. This mode is only intended to be used in natural draft applications where a fan is only required during the purge cycle to lower the purge-time requirement. Improper use of this mode may result in inadequate airflow during combustion causing an unsafe fuel mixture and/or flame blow-back which may result in death, serious injury, property damage or equipment damage.

### 7.4.3 AUX OUT 1 & AUX OUT 2 OUTPUTS

Name	Default	Options / Range	Description
<b>Mode</b>	Disabled	Disabled Level/Flow Echo Proof of Air Echo Aux In 1 Echo Aux In 2 Echo Proof of Position Echo Modbus Echo Bath Temp Echo Outlet Temp Echo Stack Temp Echo	Defines the behavior of the Auxiliary Output. See Auxiliary Outputs section for more details.
<b>Temp Echo Span Min</b>	0 °C 32 °F	-100 °C - 1350 °C -148 °F - 2462 °F	Temperature value corresponding to 4mA from the Auxiliary Output.
Span Max must be greater than Span Min			
<b>Temp Echo Span Max</b>	1350 °C 2462 °F	-100 °C - 1350 °C -148 °F - 2462 °F	Temperature value corresponding to 20mA from the Auxiliary Output.
Span Max must be greater than Span Min			

7.4.4 TCV OUTPUT

Name	Default	Options / Range	Description
Manual Override	Disabled	Disabled Enabled	Manual override of TCV functionality and proof of position alarms
Manual Position	0%	0 % - 100 %	Position of TCV when Manual Override is enabled.
Off Position	0%	0 % - 100 %	Position of TCV when system is stopped and not purging.
Min Position	40%	0 % - 70 %	Minimum position of the TCV output while in a Process Control state.
Purge Position	100%	0 % - 100 %	Position of the TCV output while system is purging.
Pilot Position	40%	0 % - 100 %	Position of the TCV output while in the Pilot state or while preparing for pilot ignition.
Light Off Position	40%	0 % - 100 %	Position of the TCV output while in the Main Light Off or Main Turndown state



Warning: The TCV **Manual Override** setting is to be used during commissioning only. Enabling **Manual Override** disables all position proving and may result in an unsafe fuel mixture and/or flame blow-back which may result in death, serious injury, property damage or equipment damage.

## 7.5 SETUP

### 7.5.1 COMMISSIONING

Name	Default	Options / Range	Description
<b>Voltage Setting</b>	12V	12V 24V	Sets the expected input voltage for the system.
<b>Voltage Restart</b>	Disabled	Disabled Enabled	Allows the system to automatically restart after a low voltage event while running.
<b>L1 Password Enable</b>	Disabled	Disabled Enabled	Enabling this mode allows L1 password control on some non-safety critical settings.
<b>Comm Loss Alarm</b>	Disabled	Disabled Enabled	Specifies whether the system will shut down when the BMS and UI lose communication with one another.
<b>Commissioning Complete</b>	Incomplete	Incomplete Complete	Setting to confirm all commissioning checks have been performed.
<b>Current Date/Time</b>	Jan 1 2000 12:00 AM		Sets the date and time for accurate event and data logging.

### 7.5.2 MODBUS

Name	Default	Options / Range	Description
<b>RTU Communication</b>	Disabled	Disabled Enabled	Enables or disables Modbus communication.
<b>Termination</b>	Disabled	Disabled Enabled	Enables or disables Modbus termination resistor.
<b>Baud Rate</b>	9600	9600 19200	Baud rate for the RS-485 link.
<b>Stop Bits</b>	1	1 2	Number of stop bits. Used for configuring the RS-485 protocol.
<b>Parity</b>	None	None Odd Even	Parity bit support. Used for configuring the RS-485 protocol.
<b>Slave Address</b>	1	1 - 247	Modbus slave address of the PF2200.

**7.5.3 UNITS**

<b>Name</b>	<b>Default</b>	<b>Options / Range</b>	<b>Description</b>
<b>Temperatures</b>	Celsius	Celsius Fahrenheit	Display units for Temperature inputs.
<b>Pressure</b>	kPa	kPa psi inch wc oz/in <sup>2</sup> kg/cm <sup>2</sup> Percent Milliamps	Display units for Pressure input.
<b>Level</b>	Litres	Litres m <sup>3</sup> US Gallons bbl ft <sup>3</sup> Percent Milliamps	Display units for Level/Flow input when configured as a Level input
<b>Flow</b>	L/sec	L/sec L/min m <sup>3</sup> /sec m <sup>3</sup> /min US Gal/sec US Gal/min bbl/sec bbl/min ft <sup>3</sup> /sec ft <sup>3</sup> /min Percent Milliamps	Display units for Level/Flow input when configured as a Flow input
<b>Airflow</b>	CFM	CFM m <sup>3</sup> /hr kPa psi inch wc Percent Milliamps	Display units for Proof of Airflow input
<b>Level/Flow Input Units</b>	Level	Level Flow	Sets whether Level/Flow Input is used as a Level input or a Flow input
<b>Aux In 1</b>	Percent	Percent Milliamps Temperature Pressure Level Flow	Display units for Aux In 1
<b>Aux In 2</b>	Percent	Percent Milliamps Temperature Pressure Level Flow	Display units for Aux In 2



## 8 MAINTENANCE

### 8.1 TRANSPORTATION AND STORAGE CONDITIONS

Transportation of the product shall be in the original product packaging or equivalent. Transportation of cards without enclosure is not recommended and should be done with the utmost care utilizing an Anti-Static/ESD bag.

Storage temperature should be kept within the operating temperature listed in Section 3 in a dry area. Avoid moisture buildup inside the enclosure.

### 8.2 REPAIR AND REPLACEMENT

Profire does not support on-site repairs for cards. For replacement cards contact Profire customer service.

In the event replacement card(s) are used, care must be taken to ensure proper firmware is loaded on both the User Interface and BMS cards. If the User Interface and BMS cards have different software bundles loaded on them, the system will fail to operate correctly and will require a firmware update to match.

BMS cards must be securely fastened into the back of the enclosure with six #10-32 machine screws.

UI cards must not be removed from the enclosure door. Should a UI card replacement be required, an entire door assembly will be shipped.

### 8.3 DECOMMISSIONING

When decommissioning the system, the appliance should be safely shut down (i.e. all safety outputs are turned off and there are no gas leaks on site). Once the appliance is in a safe state, the power should be disconnected from the PF2200. All cards should be treated like any other piece of electronics (e.g. be sent to a recycling depot).

### 8.4 USEFUL LIFE

The useful life of the PF2200 is 10 years. Prior to the expiry of that period the customer should contact Profire for a suitable replacement.

### 8.5 MANUFACTURER NOTIFICATION

Any detected failures that compromise the functional safety of the system must be reported to Profire customer service immediately.



Warning: Do not modify any system wiring or handle the electronics while the system is powered.



Caution: Do not disassemble or modify the cards in any way. The cards are not field repairable and must be sent back to Profire for replacement if damaged.



Caution: The enclosure door must be securely closed after opening. Improper closure may result in moisture or other environmental damage and may compromise the integrity of the product.

## 9 TROUBLESHOOTING

Problem	Proposed Solutions
System has visible flame but cannot detect	<ol style="list-style-type: none"> <li>1. Ensure pilot assembly, flame rod, and the gap between are fully engulfed in flame. If not, adjust rod position</li> <li>2. Ensure flame detection wiring does not exceed the recommended maximum length</li> <li>3. Ensure burner assembly has a low impedance path to Ion- terminal of BMS</li> <li>4. For longer run lengths, ensure ignition cable is used to avoid ground-loading</li> </ol>
Card is unresponsive or BMS card will not communicate with User Interface card	<ol style="list-style-type: none"> <li>1. Ensure the Status LEDs for both cards are functioning. If status LED is not functioning, cycle power (if safe to do so) and check again.</li> <li>2. Check the wiring between the BMS card and the User Interface Card.</li> </ol>
Ignition transformer "clicks" but no visible spark	<ol style="list-style-type: none"> <li>1. Ensure all wires in the ignition path are properly terminated and that there is a low impedance path from the primary-windings to the BMS card as well as the secondary-windings to the ignition rod.</li> <li>2. Ensure the gap between the ignition rod and the burner housing is within the tolerances specified in the <a href="#">Product Declarations</a> section under "High Voltage Spark Gap Range".</li> </ol>
Solenoids are not turning on, or turning on then over time turn off	<ol style="list-style-type: none"> <li>1. Ensure the solenoid is wired correctly and to the appropriate terminals. To ensure proper solenoid wiring, a multi-meter in OHM mode can be used to measure the resistance between the + and - terminal of the associated output. Note: this measurement should be done with the BMS card powered off. If properly wired, the multi-meter should read a resistance of the solenoid coil plus the run length (i.e. if the multimeter reads open, there is likely a problem with wiring).</li> <li>2. Ensure the PWM setting is correct for the appropriate solenoid. If using a peak-and-hold solenoid, the appropriate PWM setting can be found in the solenoid data sheet. Typically add a margin of 5-10% to allow for temperature variance. If using a non-peak-and-hold solenoid, ensure the PWM setting is set to 100%.</li> </ol>
Digital input will not energize	<ol style="list-style-type: none"> <li>1. Ensure the input is properly wired. See <a href="#">Connection Diagrams</a> section. In the case of a dry contact, ensure the PWR terminal is connected and is sourcing the correct voltage.</li> <li>2. Ensure adequate amount of wetting current is being applied to through contact. Run a current meter in series with the digital input switch and verify the energized state meets the requirements outlined in the <a href="#">BMS Card Electrical Ratings</a> section. If the wetting current is not adequate, the digital input either has too high of an impedance or the wiring has been compromised.</li> </ol>

# 10 ALERT CODES & RESPONSE TIMES

## 10.1 ALARMS

ID	Name	Alarm Condition	Set
AL001	Proof of Closure Contact Open	POC input is open while SSV outputs de-energized	2s
AL002	ESD Contact Open	ESD input is open	1s
AL003	Pressure Out of Range	Pressure Input in 4-20 mode: Input is less than 3 mA OR greater than 21 mA Pressure Input in Digital mode: Input is not within valid range <sup>[1]</sup>	1s
AL004	Low Pressure	Pressure Input in 4-20 mode: Input is less than Pressure Low Trip setting Pressure Input in Digital mode: Input is open	Low Pressure Delay setting
AL005	High Pressure 4-20	Pressure Input in 4-20 mode: Input is greater than High Trip setpoint AND SSV outputs energized Pressure Input in Digital mode: This alarm cannot be set	2s
AL006	High Pressure Out of Range	High Pressure input is not within valid range <sup>[1]</sup>	1s
AL007	High Pressure Contact	High Pressure input is open	2s
AL008	Pressure Configuration Error	Pressure High Trip setting is less than Pressure Low Trip plus Pressure Deadband OR Pressure Span Max is less than Pressure Span Min	0
AL009	Proof of Position Out of Range	Proof of Position Input in 4-20 mode: Input is less than 3 mA OR greater than 21 mA Proof of Position Input in Digital mode: Input is not within a valid range <sup>[1]</sup>	1s
AL010	Failed to Prove Pilot Position	Proof of Position Input in 4-20 mode: Pilot position not proven in Request Pilot Position, Ignition or Pilot state Aux In 1 or Aux In 2 in Digital Pilot Position Mode: Pilot position input stuck energized during Startup Checks state OR de-energized in Request Pilot Position, Ignition or Pilot states	2s
AL011	Failed to Prove Airflow	Fan Mode is set to Forced Draft: Airflow not proven during any running state after Startup Checks Fan Mode is set to Purge Only: Airflow is not proven during Pre-Purge state	2s
AL012	Failed to Prove Purge Position	Proof of Position Input in 4-20 mode: Purge position not proven in Request Purge Position, Prove Airflow or Pre-Purge states. Aux In 1 or Aux In 2 in Digital Pilot Position Mode: Purge position input stuck energized during Startup Checks state OR de-energized in Request Purge Position, Prove Airflow or Pre-Purge states.	2s
AL013	Failed to Prove Light Off Position	Proof of Position Input in 4-20 mode: Light Off position not proven in Request Light Off Position and Main Light Off states. Proof of Position Input in Digital Mode: Light Off position input stuck energized during Startup Checks state OR de-energized in Request Light Off Position and Main Light Off states.	2s
AL014	Level/Flow Out of Range	Level Input in 4-20 mode: Input is less than 3 mA OR greater than 21 mA Level Input in Digital mode: Input is not within a valid range <sup>[1]</sup>	1s
AL015	Low Level/Flow	Level Input in 4-20 mode: Input is less than Level Low Trip setting Level Input in Digital mode: Input is open	Level/Flow Delay setting
AL016	High Level/Flow	Level input in 4-20 mode: Input is greater than Level High Trip Level input in Digital mode: This alarm cannot be set	Level/Flow Delay setting
AL017	Level/Flow Configuration Error	Level High Trip setting is less than Level Low Trip plus Level Deadband OR Level Span Max less than Level Span Min	0
AL018	High Proof of Airflow	Proof of Airflow Input in 4-20 mode: Input is greater than High Trip setpoint Proof of Airflow Input in Digital mode: This alarm cannot be set	2s
AL019	Proof of Airflow Configuration Error	Proof of Airflow High Trip setting is less than Low Trip plus Level Deadband OR Proof of Airflow Span Max less than Span Min	0
AL020	Aux In 1 Contact Open	Aux In 1 input in 4-20 mode: This alarm cannot be set Aux In 1 input in Digital mode and Digital Trip Mode is Alarm: Input is open	2s
AL021	Aux In 1 Out of Range	Aux In 1 Input in 4-20 mode: Input is less than 3 mA OR greater than 21 mA Aux In 1 Input in Digital mode: Input is not within a valid range <sup>[1]</sup>	1s
AL022	Aux In 1 Low Trip	Aux In 1 Input in 4-20 mode: Input is less than Aux In 1 Low Trip setting Aux In 1 Input in Digital mode: This alarm cannot be set	2s
AL023	Aux In 1 High Trip	Aux In 1 Input in 4-20 mode: Input is greater than Aux In 1 High Trip setting Aux In 1 Input in Digital mode: This alarm cannot be set	2s

ID	Name	Alarm Condition	Set
		Input High Trip less than Input Low Trip plus Input Deadband OR Input Span Max less than Input Span Min OR Input High Trip greater than Input Span Max OR Input Low Trip less than Input Span Min	
AL024	Aux In 1 Configuration Error	OR Mode is Appliance Firing Rate AND Process Control Mode is not External Firing Rate OR Both Aux In 1 and Aux in 2 are set up as Appliance Firing Rate inputs OR Both Aux In 1 and Aux in 2 are set up as Process Setpoint Adjust inputs OR Both Aux In 1 and Aux in 2 are set up as UV Flame Quality inputs OR Both Aux In 1 and Aux in 2 are set up as Pilot Position inputs OR Both Aux In 1 and Aux in 2 are set up as Purge Position inputs	0
AL025	Aux In 2 Contact Open	Aux In 2 input in 4-20 mode: This alarm cannot be set Aux In 2 input in Digital mode and Digital Trip Mode is Alarm: Input is open	2s
AL026	Aux In 2 Out of Range	Aux In 2 Input in 4-20 mode: Input is less than 3 mA OR greater than 21 mA Aux In 2 Input in Digital mode: Input is not within a valid range <sup>[1]</sup>	1s
AL027	Aux In 2 Low Trip	Aux In 2 Input in 4-20 mode: Input is less than Aux In 2 Low Trip setting Aux In 2 Input in Digital mode: This alarm cannot be set	2s
AL028	Aux In 2 High Trip	Aux In 2 Input in 4-20 mode: Input is greater than Aux In 2 High Trip setting Aux In 2 Input in Digital mode: This alarm cannot be set	2s
		Input High Trip less than Input Low Trip plus Input Deadband OR Input Span Max less than Input Span Min OR Input High Trip greater than Input Span Max OR Input Low Trip less than Input Span Min	
AL029	Aux In 2 Configuration Error	OR Mode is Appliance Firing Rate AND Process Control Mode is not External Firing Rate OR Both Aux in 1 and Aux in 2 are set up as Appliance Firing Rate inputs OR Both Aux in 1 and Aux in 2 are set up as Process Setpoint Adjust inputs OR Both Aux in 1 and Aux in 2 are set up as UV Flame Quality inputs OR Both Aux In 1 and Aux in 2 are set up as Pilot Position inputs OR Both Aux In 1 and Aux in 2 are set up as Purge Position inputs	0
AL030	Process Setpoint Adjust Lacks Process Temp	Process Setpoint Adjust input is configured to use a temperature that is not set up for Process Control	0
AL031	Process Setpoint Adjust Unit Configuration Error	Process Setpoint Adjust Input units are not set to a valid temperature unit	0
AL032	Bath High Temp ESD	Bath Temperature Input is greater than High Temp ESD setpoint	2s
AL033	Bath Temp Mismatch	Bath Temperature Input 1 does not match Bath Temperature Input 2	2s
		Bath High Temp Setpoint is out of range OR Pilot Off Setpoint (if enabled) is greater than or equal to the High Temp Setpoint OR Main Off Setpoint is greater than or equal to the High Temp Setpoint	
AL034	Bath Temp Configuration Range Error	OR Main Off Setpoint is greater than the Pilot Off Setpoint (if enabled) OR Process Setpoint is greater than or equal to the High Temp Setpoint OR Process Setpoint is greater than the Pilot Off Setpoint (if enabled) OR Process Setpoint is greater than the Main Off Setpoint OR Low Temp Setpoint is greater than the Process Setpoint	0
AL035	Bath 1 Sensor Open	Bath Input 1 sensor has an open circuit	6s
AL036	Bath 1 Sensor Short	Bath Input 1 in RTD Mode: Input is measuring a short circuit Bath Input 1 in Thermocouple Mode: This alarm cannot be set	6s
AL037	Bath 1 Out of Range	Bath Input 1 in RTD Mode: Input is outside valid RTD range Bath Input 1 in Thermocouple Mode: Input is outside valid Thermocouple range	6s
AL038	Bath 1 Stale Data	Bath Input 1 is not reading valid data	6s
AL039	Bath 2 Sensor Open	Bath Input 2 sensor has an open circuit	6s
AL040	Bath 2 Sensor Short	Bath Input 2 in RTD Mode: Input is measuring a short circuit Bath Input 2 in Thermocouple Mode: This alarm cannot be set	6s
AL041	Bath 2 Out of Range	Bath Input 2 in RTD Mode: Input is outside valid RTD range Bath Input 2 in Thermocouple Mode: Input is outside valid Thermocouple range	6s
AL042	Bath 2 Stale Data	Bath Temperature Input 2 is not reading valid data	6s
AL043	Outlet High Temp ESD	Outlet Temperature Input is greater than High Temp ESD setpoint	2s
		Outlet High Temp Setpoint is out of range OR Pilot Off Setpoint (if enabled) is greater than or equal to the High Temp Setpoint OR Main Off Setpoint is greater than or equal to the High Temp Setpoint	
AL044	Outlet Temp Configuration Range Error	OR Main Off Setpoint is greater than the Pilot Off setpoint (if enabled) OR Process Setpoint is greater than or equal to the High Temp Setpoint OR Process Setpoint is greater than the Pilot Off Setpoint (if enabled) OR Process Setpoint is greater than the Main Off Setpoint OR Low Temp Setpoint is greater than the Process Setpoint	0
AL045	Outlet Sensor Open	Outlet Input sensor has an open circuit	6s

ID	Name	Alarm Condition	Set
AL046	Outlet Sensor Short	Outlet Input in RTD Mode: Input is measuring a short circuit Outlet Input in Thermocouple Mode: This alarm cannot be set	6s
AL047	Outlet Out of Range	Outlet Input in RTD Mode: Input is outside valid RTD range Outlet Input in Thermocouple Mode: Input is outside valid Thermocouple range	6s
AL048	Outlet Stale Data	Outlet Temperature Input is not reading valid data	6s
AL049	Stack High Temp ESD	Stack Temperature Input is greater than High Temp ESD setpoint	2s
AL050	Stack Temp Configuration Range Error	Stack High Temp Setpoint is out of range	0
AL051	Stack Sensor Open	Stack Input sensor has an open circuit	6s
AL052	Stack Sensor Short	Stack Input in RTD Mode: Input is measuring a short circuit Stack Input in Thermocouple Mode: This alarm cannot be set	6s
AL053	Stack Out of Range	Stack Input in RTD Mode: Input is outside valid RTD range Stack Input in Thermocouple Mode: Input is outside valid Thermocouple range	6s
AL054	Stack Stale Data	Stack Input is not reading valid data	6s
AL055	Ambient Temp Mismatch	Ambient Temperature Measurement mismatch between sensors <sup>[2]</sup>	6s
AL056	Ambient Temp 1 Invalid	Ambient Temperature sensor 1 on BMS card is reporting an invalid reading <sup>[2]</sup>	6s
AL057	Ambient Temp 2 Invalid	Ambient Temperature sensor 2 on BMS card is reporting an invalid reading <sup>[2]</sup>	6s
AL058	No Process Temp Configured	Neither Bath nor Outlet temperature input is configured to be in Process Control mode	0
AL059	Pilot 1 Flame Fail	Pilot 1 has lost flame OR failed to ignite	0
AL060	Pilot 2 Flame Fail	Pilot 2 has lost flame OR failed to ignite	0
AL061	Pilot 1 Flame Detected While Off	Flame has been detected on Pilot 1 input before Pilot ignition	0
AL062	Pilot 2 Flame Detected While Off	Flame has been detected on Pilot 2 input before Pilot ignition	0
AL063	UV Flame Detected While Off	UV Detect Mode is Disabled: This alarm cannot be set UV Detect Mode is Main Only: UV Flame detected before Pilot Ignition or Main Light Off UV Detect Mode is Pilot and Main: UV Flame detected before Pilot Ignition	0
AL064	Reserved		
AL065	Reserved		
AL066	Reserved		
AL067	Airflow Input Stuck	Airflow detected during Startup Checks state	0
AL068	Flame 1 Ion+ Wiring Fault	AC voltage on Pilot 1 input too low to reliably detect flame <i>Note: Usually caused by loading of the flame rod to ground</i>	3s
AL069	Flame 2 Ion+ Wiring Fault	AC voltage on Pilot 2 input too low to reliably detect flame <i>Note: Usually caused by loading of the flame rod to ground</i>	3s
AL070	Pilot ADC Start Fault	Internal BMS Card fault <sup>[2]</sup>	2s
AL071	Pilot ADC Read Fault	Internal BMS Card fault <sup>[2]</sup>	2s
AL072	Pilot ADC Stop Fault	Internal BMS Card fault <sup>[2]</sup>	2s
AL073	Flame 1 Voltage Fault	Pilot Flame 1 flame test failure <sup>[2]</sup>	3s
AL074	Flame 2 Voltage Fault	Pilot Flame 2 flame test failure <sup>[2]</sup>	3s
AL075	Low Voltage	In 12V Mode: System Voltage is less than 9.5V In 24V Mode: System Voltage is less than 19.0V	2s
AL076	High Voltage	In 12V Mode: System Voltage is greater than 16.8V In 24V Mode: System Voltage is greater than 33.6V	2s
AL077	System ADC Start Fault	Internal BMS Card fault <sup>[2]</sup>	2s
AL078	System ADC Read Fault	Internal BMS Card fault <sup>[2]</sup>	2s
AL079	System ADC Stop Fault	Internal BMS Card fault <sup>[2]</sup>	2s
AL080	Commissioning Setting is Set to Incomplete	The Commissioning Complete setting is set to Incomplete	0
AL081	Cross Compare Failure	Internal BMS Card fault <sup>[2]</sup>	2s
AL082	External Switch Stuck	External switch input is stuck in the Ignite position	5s
AL083	External Switch Invalid	External switch input is in an invalid position	0
AL084	User Stop via External Switch	External switch input is in the off position	0
AL085	User Stop via Interface	The BMS card received a stop command from the UI or remote Modbus device	0
AL086	Settings CRC Failed	Settings have been corrupted and cannot be verified	0
AL087	State Mismatch	Internal BMS Card fault <sup>[2]</sup>	1s
AL088	Pressure I2C Bus Fault	Internal BMS Card fault <sup>[2]</sup>	2s
AL089	High Pressure I2C Bus Fault	Internal BMS Card fault <sup>[2]</sup>	2s
AL090	Reserved		
AL091	Level/Flow I2C Bus Fault	Internal BMS Card fault <sup>[2]</sup>	2s

ID	Name	Alarm Condition	Set
AL092	Reserved		
AL093	Aux In 1 I2C Bus Fault	Internal BMS Card fault <sup>[2]</sup>	2s
AL094	Aux In 2 I2C Bus Fault	Internal BMS Card fault <sup>[2]</sup>	2s
AL095	Pilot 1 I2C Bus Fault	Internal BMS Card fault <sup>[2]</sup>	2s
AL096	Pilot 2 I2C Bus Fault	Internal BMS Card fault <sup>[2]</sup>	2s
AL097	SSV1 I2C Bus Fault	Internal BMS Card fault <sup>[2]</sup>	2s
AL098	SSV2 I2C Bus Fault	Internal BMS Card fault <sup>[2]</sup>	2s
AL099	Reserved		
AL100	System Voltage Current I2C Bus Fault	Internal BMS Card fault <sup>[2]</sup>	2s
AL101	IO Short Switch Run Fault	Internal BMS Card fault <sup>[2]</sup>	1.5s
AL102	IO Short Switch Ignition Fault	Internal BMS Card fault <sup>[2]</sup>	1.5s
AL103	IO Short Start Fault	Internal BMS Card fault <sup>[2]</sup>	1.5s
AL104	IO Short POC Fault	Internal BMS Card fault <sup>[2]</sup>	1.5s
AL105	IO Short UV Flame Off Fault	Internal BMS Card fault <sup>[2]</sup>	1.5s
AL106	IO Short UV Fault	Internal BMS Card fault <sup>[2]</sup>	1.5s
AL107	IO Short ESD Fault	Internal BMS Card fault <sup>[2]</sup>	1.5s
AL108	Reserved		
AL109	Reserved		
AL110	Reserved		
AL111	Flash Failed To Read	Internal BMS Card fault <sup>[2]</sup>	0
AL112	Flash Failed To Write	Internal BMS Card fault <sup>[2]</sup>	0
AL113	Descriptor Failure	Internal BMS Card fault <sup>[2]</sup>	0
AL114	Descriptor Mismatch	Internal BMS Card fault <sup>[2]</sup>	0
AL115	Pilot 1 Valve Output Voltage Fault	Pilot 1 output is de-energized and voltage at BMS terminal 15 is greater than 5V	10s
AL116	Pilot 2 Valve Output Voltage Fault	Pilot 2 output is de-energized and voltage at BMS terminal 17 is greater than 5V	10s
AL117	SSV1 Output Voltage Fault	SSV 1 output is de-energized and voltage at BMS terminal 19 is greater than 5V	10s
AL118	SSV2 Output Voltage Fault	SSV 2 output is de-energized and voltage at BMS terminal 21 is greater than 5V	10s
AL119	Proof of Airflow Out of Range	Proof of Airflow Input in 4-20 mode: Input is less than 3 mA OR greater than 21 mA Proof of Airflow Input in Digital mode: Input is not within a valid range <sup>[1]</sup>	1s
AL120	Start Contact Out of Range	Input is not within a valid range <sup>[1]</sup>	2s
AL121	POC Contact Out of Range	Input is not within a valid range <sup>[1]</sup>	2s
AL122	ESD Contact Out of Range	Input is not within a valid range <sup>[1]</sup>	2s
AL123	UV Flame On Contact Out of Range	Input is not within a valid range <sup>[1]</sup>	2s
AL124	UV Flame Off Contact Out of Range	Input is not within a valid range <sup>[1]</sup>	2s
AL125	UV Flame Fault Contact Out of Range	Input is not within a valid range <sup>[1]</sup>	2s
AL126	Digital Input ADC Start Fault	Internal BMS Card fault <sup>[2]</sup>	2s
AL127	Digital Input ADC Read Fault	Internal BMS Card fault <sup>[2]</sup>	2s
AL128	Digital Input ADC Stop Fault	Internal BMS Card fault <sup>[2]</sup>	2s
AL129	Safety Output Mismatch	Internal BMS Card fault <sup>[2]</sup>	2s
AL130	Processor Reset	Internal BMS Card fault <sup>[2]</sup>	0
AL131	Calibration CRC Failed	Internal BMS Card fault <sup>[2]</sup>	0
AL132	Brownout Reset Voltage Incorrect	Internal BMS Card fault <sup>[2]</sup>	0
AL133	Flame 1 DC Input Open	Internal BMS Card fault <sup>[2]</sup>	3s
AL134	Flame 2 DC Input Open	Internal BMS Card fault <sup>[2]</sup>	3s
AL135	Factory Calibration Error	Internal BMS Card fault <sup>[2]</sup>	0
AL136	UV Flame Detect Mismatch	UV Flame Scanner Flame input and No Flame Input are both open or both closed	1s
AL137	UV Flame Detect Fault	UV Flame Scanner Fault input is open	1s
AL138	Interrupted Pilot Requires Main Flame Detection	Pilot Off Mode is Interrupted and UV Flame Detect Mode is disabled	0
AL139	Proof of Position Configuration Error	Proof of Position input in 4-20 Mode: Aux In 1 and or Aux In 2 are configured as digital proof of pilot or proof of purge inputs. Proof of Position input in Digital Mode: This alarm cannot be set	0
AL140	UV Flame Fail	Loss of UV flame	0
AL141	Appliance Firing Rate Aux Input Not Enabled	Process Control Mode is Firing Rate and Aux In 1/2 not set up as Firing Rate input	0
AL142	Shutdown Failed To Set	Internal BMS Card fault <sup>[2]</sup>	0

ID	Name	Alarm Condition	Set
AL143	Reserved		
AL144	Fan Output Voltage Fault	Fan output is de-energized and voltage at BMS terminal 23 is greater than 5V	10s
AL145	Pilot 2 Enabled with UV Pilot Detect	Pilot 2 is enabled when UV Flame Detect Mode is set to Pilot and Main	0
AL146	System Voltage Mismatch	Internal BMS Card fault <sup>[2]</sup>	10s
AL147	Proof of Position I2C Bus Fault	Internal BMS Card fault <sup>[2]</sup>	2s
AL148	Proof of Air I2C Bus Fault	Internal BMS Card fault <sup>[2]</sup>	2s
AL149	Fan I2C Bus Fault	Internal BMS Card fault <sup>[2]</sup>	2s
AL150	Level/Flow Control Setpoint Configuration Error	Run Status Level/Flow Control setting is outside Level/Flow Low and High Trip setpoints	0
AL151	UI Comm Loss	Comm Loss Alarm setting enabled: Communication loss between BMS and UI Cards Comm Loss Alarm setting disabled: This alarm cannot be set	10s
AL152	Invalid Aux Out Mode Selected	Configured Aux Output Mode is not supported	0
AL153	Reignition Configuration Error	Reignition enabled: Minimum Pilots Running is 2 OR Pilot 2 is disabled Reignition disabled: This alarm cannot be set	0
AL154	Pilot 2 Disabled While Min Pilots is 2	Minimum Pilots Running is 2 and Pilot 2 is disabled	0
AL155	PID Configuration Error	Process Control Mode is set to PID control with a temperature input that is not set to process control	0
AL156	Level/Flow Control Requires 4-20 Input	Run Status Mode is Level/Flow Control: Level/Flow input type is disabled or digital Run Status Mode is not Level/Flow Control: This alarm cannot be set	0
AL157	Flame Detect Software Watchdog Trip	Internal BMS Card fault	0

<sup>[1]</sup> This fault can occur in one of two scenarios: a negative voltage is present on the Signal In terminal OR the BMS card has been compromised

<sup>[2]</sup> This fault usually occurs when the BMS card has been compromised

## 10.2 WAITS

<b>ID</b>	<b>Name</b>	<b>Wait Condition</b>	<b>Set</b>
<b>WT001</b>	Low Voltage	In 12V Mode: Voltage Restart is enabled AND System Voltage is less than 9.5V In 24V Mode: Voltage Restart is enabled AND System Voltage is less than 19.0V	2s
<b>WT002</b>	High Voltage	In 12V Mode: Voltage Restart is enabled AND System Voltage is greater than 16.8V In 24V Mode: Voltage Restart is enabled AND System Voltage is greater than 33.6V	2s
<b>WT003</b>	Low Pressure <sup>1</sup>	Pressure Input in 4-20 mode: Input is less than Pressure Low Trip setting Pressure Input in Digital mode: Input is open	Low Pressure Delay setting
<b>WT004</b>	Low Level/Flow <sup>1</sup>	Level Input in 4-20 mode: Input is less than Level Low Trip setting Level Input in Digital mode: Input is open	Level/Flow Delay setting
<b>WT005</b>	High Level/Flow <sup>1</sup>	Level input in 4-20 mode: Input is greater than Level High Trip Level input in Digital mode: This wait cannot be set	Level/Flow Delay setting
<b>WT006</b>	High Bath Temp	Bath temperature is too high to require the system to be in a fuel state. Refer to Operating Sequence section for configuration specific behavior	2s
<b>WT007</b>	High Outlet Temp	Outlet temperature is too high to require the system to be in a fuel state. Refer to Operating Sequence section for configuration specific behavior	2s
<b>WT008</b>	Start Contact Open	Start contact open	1s
<b>WT009</b>	Aux In 1 Contact Open <sup>1</sup>	Aux In 1 input in 4-20 mode: This wait cannot be set Aux In 1 input in Digital mode: Input is open	2s
<b>WT010</b>	Aux In 1 Low Trip <sup>1</sup>	Aux In 1 Input in 4-20 mode: Input is less than Aux In 1 Low Trip setting Aux In 1 Input in Digital mode: This wait cannot be set	2s
<b>WT011</b>	Aux In 1 High Trip <sup>1</sup>	Aux In 1 Input in 4-20 mode: Input is greater than Aux In 1 High Trip setting Aux In 1 Input in Digital mode: This wait cannot be set	2s
<b>WT012</b>	Aux In 2 Contact Open <sup>1</sup>	Aux In 2 input in 4-20 mode: This wait cannot be set Aux In 2 input in Digital mode: Input is open	2s
<b>WT013</b>	Aux In 2 Low Trip <sup>1</sup>	Aux In 2 Input in 4-20 mode: Input is less than Aux In 2 Low Trip setting Aux In 2 Input in Digital mode: This wait cannot be set	2s
<b>WT014</b>	Aux In 2 High Trip <sup>1</sup>	Aux In 2 Input in 4-20 mode: Input is greater than Aux In 2 High Trip setting Aux In 2 Input in Digital mode: This wait cannot be set	2s

<sup>1</sup> Associated Trip Mode setting must be configured as a Wait



### 10.3 WARNINGS

ID	Name	Warning Condition	Set
WN001	Low Voltage	In 12V Mode: System Voltage is less than 10.2V In 24V Mode: System Voltage is less than 20.4V	2s
WN002	High Voltage	In 12V Mode: System Voltage is greater than 16.2V In 24V Mode: System Voltage is greater than 32.4V	2s
WN003	Low Level/Flow <sup>1</sup>	Level Input in 4-20 mode: Input is less than Level Low Trip setting Level Input in Digital mode: Input is open	Level/Flow Delay setting
WN004	High Level/Flow <sup>1</sup>	Level input in 4-20 mode: Input is greater than Level High Trip Level input in Digital mode: This warning cannot be set	Level/Flow Delay setting
WN005	Low Bath Temp	Bath Temperature reading is at or below the Bath Low Temp Setpoint	2s
WN006	Low Outlet Temp	Outlet Temperature reading is at or below the Outlet Low Temp Setpoint	2s
WN007	High Pressure 4-20	Pressure in 4-20 mode: Input is greater than High Trip setpoint AND SSV outputs de-energized Pressure in Digital mode: This warning cannot be set	2s
WN008	Low Pressure <sup>1</sup>	Pressure Input in 4-20 mode: Input is less than Pressure Low Trip setting Pressure Input in Digital mode: Input is open	Low Pressure Delay setting
WN009	Aux In 1 Contact Open <sup>1</sup>	Aux In 1 input in 4-20 mode: This warning cannot be set Aux In 1 input in Digital mode: Input is open	2s
WN010	Aux In 1 Low Trip <sup>1</sup>	Aux In 1 Input in 4-20 mode: Input is less than Aux In 1 Low Trip setting Aux In 1 Input in Digital mode: This warning cannot be set	2s
WN011	Aux In 1 High Trip <sup>1</sup>	Aux In 1 Input in 4-20 mode: Input is greater than Aux In 1 High Trip setting Aux In 1 Input in Digital mode: This warning cannot be set	2s
WN012	Aux In 2 Contact Open <sup>1</sup>	Aux In 2 input in 4-20 mode: This warning cannot be set Aux In 2 input in Digital mode: Input is open	2s
WN013	Aux In 2 Low Trip <sup>1</sup>	Aux In 2 Input in 4-20 mode: Input is less than Aux In 2 Low Trip setting Aux In 2 Input in Digital mode: This warning cannot be set	2s
WN014	Aux In 2 High Trip <sup>1</sup>	Aux In 2 Input in 4-20 mode: Input is greater than Aux In 2 High Trip setting Aux In 2 Input in Digital mode: This warning cannot be set	2s
WN015	POC Contact Failed to Open	Proof of Closure Input enabled: Proof of Closure input closed AND SSV outputs are energized Proof of Closure Input disabled: This warning cannot be set	10s
WN016	Reserved		
WN017	UI to BMS Firmware Mismatch	UI and BMS firmware do not match	0
WN018	BMS Comm Loss	UI Comm Loss Alarm Setting is Enabled AND UI card has lost communications with the BMS card	0
WN019	Hardware Descriptor Error	Internal BMS Card fault	0
WN020	Product Variant Descriptor Error	Internal BMS Card fault	0
WN021	Firmware Descriptor Error	Internal BMS Card fault	0
WN022	Bootloader Descriptor Error	Internal BMS Card fault	0
WN023	UI Descriptor Error	Internal UI Card fault	0
WN024	Outlet Sensor Open	Outlet Mode is Display Only AND Outlet Input has a TC Open or RTD Open fault.	6s
WN025	Outlet Sensor Short	Outlet Mode is Display Only AND Outlet Input has an RTD short fault.	6s
WN026	Outlet Out of Range	Outlet Mode is Display Only AND Outlet Input is outside valid RTD or Thermocouple range	6s
WN027	Outlet Stale Data	Outlet Mode is Display Only AND Outlet Input is not reading valid data	6s
WN028	Stack Sensor Open	Stack Mode is Display Only AND Stack Input has a TC Open or RTD Open fault.	6s
WN029	Stack Sensor Short	Stack Mode is Display Only AND Stack Input has an RTD short fault.	6s
WN030	Stack Out of Range	Stack Mode is Display Only AND Stack Input is outside valid RTD or Thermocouple range	6s
WN031	Stack Stale Data	Stack Mode is Display Only AND Stack Input is not reading valid data	6s
WN032	Aux Output 1 Fault	Aux Output 1 wiring problem or board fault	2s
WN033	Aux Output 2 Fault	Aux Output 2 wiring problem or board fault	2s
WN034	TCV Fault	TCV Output wiring problem or board fault	2s
WN035	Pilot 1 Flame Lost	Minimum Pilots Running is 1: System running with Pilot 2 flame only and Pilot 1 output de-energized Minimum Pilots Running is 2: This warning cannot be set	0
WN036	Pilot 2 Flame Lost	Minimum Pilots Running is 1: System running with Pilot 1 flame only and Pilot 2 output de-energized Minimum Pilots Running is 2: This warning cannot be set	0
WN037	TCV Manual Override Enabled	TCV Manual Override setting is enabled	0

<sup>1</sup> Associated Trip Mode setting must be configured as a Warning

## 10.4 MAIN PERMISSIVES

ID	Name	Main Permissive Condition	Set
MP001	Low Pressure <sup>1</sup>	Pressure Input in 4-20 mode: Input is less than Pressure Low Trip setting Pressure Input in Digital mode: Input is open	Low Pressure Delay setting
MP002	Aux In 1 Contact Open <sup>1</sup>	Aux In 1 input in 4-20 mode: This main permissive cannot be set Aux In 1 input in Digital mode: Input is open	2s
MP003	Aux In 1 Low Trip <sup>1</sup>	Aux In 1 Input in 4-20 mode: Input is less than Aux In 1 Low Trip setting Aux In 1 Input in Digital mode: This main permissive cannot be set	2s
MP004	Aux In 1 High Trip <sup>1</sup>	Aux In 1 Input in 4-20 mode: Input is greater than Aux In 1 High Trip setting Aux In 1 Input in Digital mode: This main permissive cannot be set	2s
MP005	Aux In 2 Contact Open <sup>1</sup>	Aux In 2 input in 4-20 mode: This main permissive cannot be set Aux In 2 input in Digital mode: Input is open	2s
MP006	Aux In 2 Low Trip <sup>1</sup>	Aux In 2 Input in 4-20 mode: Input is less than Aux In 2 Low Trip setting Aux In 2 Input in Digital mode: This main permissive cannot be set	2s
MP007	Aux In 2 High Trip <sup>1</sup>	Aux In 2 Input in 4-20 mode: Input is greater than Aux In 2 High Trip setting Aux In 2 Input in Digital mode: This main permissive cannot be set	2s

<sup>1</sup> Associated Trip Mode setting must be configured as a Main Permissive

# 11 GLOSSARY

<b>Alarm</b>	An indication of an abnormal condition in either the equipment or the process.	<b>Non-volatile Lockout</b>	Condition such that a restart can only be accomplished by a manual reset of the system and by no other cause
<b>Continuous Pilot</b>	A pilot which, once placed in operation, is intended to remain ignited continuously until it is manually interrupted	<b>Permanent Operation</b>	System which is intended to remain in the running position for longer than 24 h without interruption
<b>Digital Input</b>	An input to the system that can be one of only two states (Energized or De-energized).	<b>Pilot-flame Establishing Period</b>	Period of time between the signal to energize the pilot fuel flow means and the signal indicating presence of the pilot flame
<b>Electronic Disconnection</b>	Non-cycling interruption by an electronic device of a circuit for functional disconnection which provides a disconnection other than by means of an air gap by satisfying certain electrical requirements in at least one pole	<b>Post-Ignition Time</b>	Period of time between the signal indicating presence of flame and the signal to de-energize the ignition device
<b>Flame Detector</b>	Device which provides the programming unit with a signal indicating the presence of absence of flame	<b>Post-Purge Time</b>	Purge time that takes place immediately following the shutting off of the fuel supply
<b>Flame Detector Response Time</b>	Period of time between loss of the sensed flame and the signal indicating the absence of flame	<b>Pre-Ignition Time</b>	Period of the ignition time between the signal to ignite and the signal to energize the fuel flow means
<b>Flame Detector Self-Checking Rate</b>	Frequency of self-checking function of the flame detector (in number of operations per unit of time)	<b>Pre-Purge Time</b>	Purge time that takes place between initiation of a burner control sequence and the admission of fuel to the burner
<b>Flame Failure Lock-out Time</b>	Period of time between the signal indicating absence of flame and lock-out	<b>Recycle Time</b>	Period of time between the signal to de-energize the fuel flow means following the loss of flame and the signal to begin a new start-up procedure
<b>Full Rate Start</b>	Condition in which the main burner ignition and subsequent flame supervision occur at full fuel rate	<b>Safety Output</b>	A powered electrical output from the PF2200 BMS card designed to control safety actuators (e.g. safety shut off valves, ignition coils, etc.). Safety Outputs of the PF2200 BMS card are as follows: Pilot 1, Pilot 2, SSV, High Fire, Coil 1, and Coil 2.
<b>Ignition Time</b>	Period of time during which the ignition device is energized	<b>Safety-interlock</b>	A term used to describe an input (either switch or Transmitter) that must be satisfied to run. If the interlock is not satisfied (e.g. open switch or out of range transmitter) the system will proceed to lock-out.
<b>Incorporated Control</b>	Control intended for incorporation in, or on, an equipment, but which can be tested separately.	<b>Shutdown</b>	The process the system goes through when it receives an alarm event while running. This is immediately followed by entering the state of Lockout.
<b>Intermittent Pilot</b>	A pilot which is automatically ignited when an appliance is called on to operate and which remains continuously ignited during each period of main burner operation. The pilot is automatically extinguished when each main burner operating cycle is completed	<b>Signal for Absence of Flame</b>	Maximum signal which indicates the loss of flame
<b>Interrupted Ignition</b>	A type of ignition which is energized prior to the admission of fuel to the main burner and which is de-energized when the main flame is established	<b>Signal for Presence of Flame</b>	Minimum signal which indicates the presence of flame when there was previously no flame
<b>Interrupted Pilot</b>	A pilot which is automatically ignited prior to the admission of fuel to the main burner and which is automatically extinguished when the main flame is established	<b>Start-up Lock-out Time</b>	Period of time between the signal to energize the fuel flow means and lock-out
<b>Lockout</b>	A state in which all powered outputs (Valves and Ignition) are de-energized and interaction from the user is required in order to exit the state.	<b>Type 2 Action</b>	Automatic action for which the manufacturing deviation and the drift of its operating value, operating time, or operating sequence have been declared and tested per IEC 60730
<b>Low Rate Start</b>	Condition in which main burner ignition occurs at low fuel rate. Once ignition at low fuel rate occurs and the flame is proven, full main burner fuel rate may be admitted	<b>Wait</b>	An event which causes the BMS to proceed to a state which will de-energize all safety outputs. When all wait events clear, the BMS is free to automatically recycle.
<b>Main Permissive</b>	An event which causes the BMS to de-energize the main solenoid outputs (SSV) and remain in that state until the event clears (or an alarm / wait condition forces the BMS out)	<b>Waiting Time</b>	Period between the start signal and the signal to energize the ignition device. For burners without fans, natural ventilation of the combustion chamber and the flue passages normally takes place during this time.
<b>Maximum Flame-failure Reignition Time</b>	Period of time between the signal indicating absence of flame and the signal to energize the ignition device. During this time period the fuel supply is not shut off.		

## 12 ACRONYMS

<b>1oo1</b>	One out of One deployment	<b>PWM</b>	Pulse Width Modulation
<b>BMS</b>	Burner Management System	<b>RTD</b>	Resistive Thermal Device
<b>ESD</b>	Emergency Shut Down – a mechanism that shuts down the system in the event of a safety emergency	<b>SIL</b>	Safety Integrity Level. A discrete level (one out of a possible four) for specifying the safety integrity requirements of the safety functions to be allocated to the E/E/PE safety-related systems where Safety Integrity Level 4 has the highest level of safety integrity, and Safety Integrity Level 1 has the lowest
<b>HEI</b>	High Energy Ignition	<b>SIF</b>	Safety Instrumented Function. A set of equipment intended to reduce the risk due to a specific hazard (a safety loop)
<b>HFT</b>	Hardware Fault Tolerance	<b>SFF</b>	Safe Failure Fraction. The fraction of the overall failure rate of a device that results in either a safe fault or a diagnosed unsafe fault
<b>HFV</b>	High Fire Valve	<b>SSV</b>	Safety shutoff valve.
<b>I/O</b>	The generic name for a terminal that can be an input, output, or a combination of both.	<b>TCV</b>	Temperature Control Valve
<b>PF2200-FD</b>	The model number for the PF2200 Forced Draft BMS product. Consists of: BMS Card, User Interface Card, keypad, and enclosure.		
<b>PoC</b>	Proof of Closure		
<b>PFN</b>	Profire Network. Method of communication between User Interface Card and BMS Card.		

# 13 DOCUMENT REVISION HISTORY

Document Version	Release Date	Applicable BMS Hardware	Applicable UI Hardware	Applicable Firmware
v4.0	25 OCT 2021	v2.3.x	v3.2.x	FD 2.1.2
v3.0	29 SEP 2021	v2.3.x	v3.2.x	FD 2.1.2
v2.0	02 FEB 2021	v2.3.x	v3.2.x	FD 2.1.2
v1.0	30 SEP 2020	v2.3.0	v3.2.0	FD 2.0.4

## 13.1 CHANGE SUMMARY

### 13.1.1 VERSION 4.0

- Added French safety warnings.

### 13.1.2 VERSION 3.0

- Added UL certification information on p.4
- Added settings modification helper graphic on p.12
- Added firmware update section to p.15
- Corrected Dual Rod Ignition wiring diagram on p.66

### 13.1.3 VERSION 2.0

- Updated to specify that document applies to FD 2.1.2 firmware.
- Fixed duplicated terminal numbers in UI ratings section.
- Fixed psi to gal typo in section 7.2.1
- Updated alarm set times for AL068, 069, 073, 074, 082, 133 and 134.



**UNITED STATES**

1.801.796.5127  
321 South, 1250 West Suite 1  
Lindon, UT 84042, USA  
[support@profireenergy.com](mailto:support@profireenergy.com)

**CANADA**

1.780.960.5278  
9671 - 283 Street  
Acheson, AB T7X 6J5, Canada  
[support@profireenergy.com](mailto:support@profireenergy.com)