



PF3100

Product Manual

DOC-001149 v8.0

PROFIRE

CONTENTS

1	IMPORTANT SAFETY INFORMATION	4	6.4	Main Ionization Flame Detection Input	46
2	DOCUMENT SCOPE	5	6.5	Pilot Ionization Flame Detection Input	46
2.1	Additional Documentation	5	6.6	Pilot Ignition Coil Output	48
3	APPROVALS AND RATINGS	6	6.7	PFRN Port.....	49
3.1	Certifications.....	6	7	PF3102-01 UV PILOT CARD	50
3.2	Product Declarations.....	7	7.1	Terminal Ratings	50
3.3	Product Specifications.....	7	7.2	Ignition Enable Relay Contact	51
3.4	Enclosure Specifications	8	7.3	Required UV Flame Scanner Inputs	52
4	PF3100-00 USER INTERFACE CARD	9	7.4	UV Flame Scanner Flame Strength Input	53
4.1	Terminal Ratings	9	7.5	PFRN Port.....	54
4.2	Keypad.....	10	7.6	Dip Switches	55
4.3	User Interface Display	11	7.7	Power Setting LEDs.....	55
4.4	Status LED	15	8	PF3102-03 PILOT SPARK CARD	56
4.5	PFRN Controller Network Port.....	16	8.1	Terminal Ratings	56
4.6	USB Port	17	8.2	Power Input.....	57
4.7	SD Card Slot.....	17	8.3	Coil Enable Input.....	57
4.8	Battery	17	8.4	Coil Ignition Output	57
5	PF3101-00 BMS CONTROLLER CARD	18	9	PF3103-00 TEMPERATURE CARD	58
5.1	Terminal Ratings	19	9.1	Terminal Ratings	58
5.2	Controller Power Input.....	20	9.2	Thermocouple Inputs.....	59
5.3	Status Contact	21	9.3	PFRN Port.....	61
5.4	High Fire Valve Solenoid Output.....	22	10	PF3106-00 NETWORK CARD	62
5.5	Main Valve Solenoid Output 2.....	23	10.1	Terminal Ratings	62
5.6	Main Valve Solenoid Output 1.....	24	10.2	Power Input.....	63
5.7	Pilot Valve Solenoid Output.....	25	10.3	PFRN Ports.....	64
5.8	Auxiliary 4-20mA Output	26	11	PF3107-00 MODBUS CARD	65
5.9	Remote Start Input	28	11.1	Terminal Ratings	65
5.10	Proof of Closure Input.....	29	11.2	Power Input	66
5.11	Auxiliary Input	30	11.3	Start Input.....	67
5.12	Emergency Shutdown Input.....	33	11.4	Status Output.....	67
5.13	Fuel Pressure Input.....	34	11.5	Modbus Connection	68
5.14	Level/Flow Input.....	36	11.6	PFRN Ports.....	69
5.15	PFRN Controller Network.....	38	12	PF3113-00 I/O EXPANSION CARD	70
5.16	PFRN I/O Network.....	39	12.1	Terminal Ratings	70
5.17	External Ignition Switch Input	41	12.2	Normally Closed Dry Contact.....	71
5.18	BMS Front Panel LED Output	42	12.3	Normally Open Dry Contact.....	72
6	PF3102-00 ION PILOT CARD	43	12.4	4-20 mA Output	73
6.1	Terminal Ratings	43	12.5	Configurable I/O Expansion Inputs	76
6.2	Ion Auxiliary Input.....	44	12.6	PFRN Port.....	83
6.3	Ion Pilot Valve Output	45			

13	OPERATING SEQUENCE	84	17	SYSTEM OPERATION	163
13.1	Power On State	85	17.1	Starting the System	163
13.2	Alarm State	86	17.2	Accessing System Status Information.....	164
13.3	Ready State	87	17.3	Adjusting Setpoints.....	164
13.4	Lockout State.....	88	17.4	Adjusting Input and Output Settings	164
13.5	Waiting State.....	89	17.5	Stopping the System	165
13.6	Startup Checks State	92	17.6	Reigniting a Lost Pilot.....	166
13.7	Proven Pre-Purge Sequence.....	93	17.7	Acknowledging Lockouts	166
13.8	Ignition State.....	97	17.8	Advanced PF3100 Software Features	167
13.9	Pilot State	98	18	SOFTWARE UTILITIES	169
13.10	Low Fire State	101	18.1	Quick Start Setup Tool	169
13.11	Process Control States	103	18.2	Swap Wizard	169
14	INSTALLATION	107	18.3	Diagnostics	172
14.1	Mounting Considerations	107	18.4	Logging.....	173
14.2	Hardware Installation Diagrams.....	109	18.5	Settings.....	175
14.3	Connection Diagrams.....	110	18.6	Firmware.....	177
15	SYSTEM CONFIGURATION	123	19	MAINTENANCE	179
15.1	Appliance	123	19.1	Tools Required	179
15.2	BMS Controller	123	19.2	Regular Maintenance Recommendations ...	179
15.3	I/O Card	123	19.3	Repair and Replacement	179
15.4	Modbus Card	123	19.4	Decommissioning	179
15.5	Network Card	123	19.5	Manufacturer Notification.....	179
15.6	Communication.....	123	20	ALERT CODES	180
15.7	Card Identification	123	20.1	Alarms	180
15.8	System Scaling.....	124	20.2	Waits	190
16	COMMISSIONING	125	20.3	Warnings.....	192
16.1	Passwords.....	125	20.4	Main Permissives.....	195
16.2	Update Firmware	125	21	GLOSSARY	197
16.3	User Interface Settings.....	126	21.1	Terms	197
16.4	Appliance Wizard	127	21.2	Acronyms	197
16.5	Temperature Wizard	128	22	DOCUMENT REVISION HISTORY	198
16.6	Pilot Wizard.....	131	22.1	Hardware and Firmware Versions.....	198
16.7	I/O Expansion Wizard.....	133	22.2	Document Change Summary.....	198
16.8	Output Calibration Wizard.....	136			
16.9	FARC/O ₂ Trim Wizard.....	137			
16.10	BMS Controller Settings	142			
16.11	FARC Tuning Settings.....	160			
16.12	O ₂ Trim Tuning.....	161			
16.13	Test System.....	162			
16.14	Save Settings.....	162			

1 IMPORTANT SAFETY INFORMATION



Warning: All PF3100 installations must follow the installation, commissioning, operation and maintenance procedures outlined in this manual. Failure to comply with the instructions and warnings in this manual may result in death, serious injury, electrocution, property damage, product damage and/or government fines. All PF3100 installations must be performed in accordance with local electrical code(s) by a capable electrician and must be field inspected by the Authority Having Jurisdiction to ensure compliance with local electrical and gas codes.



Warning: Do not disconnect power, open enclosures, or otherwise service the product unless area is known to be non-hazardous.



Warning: Do not remove or replace fuses when system is powered. Replacement fuses must be ceramic and of correct rating. [Contact Profire](#) for replacement fuses.



Warning: All safety functions being used must be end-to-end proven following commissioning of the system.



Warning: Ignition coils can generate 20 kV - 40 kV at their high voltage output terminals and can cause cardiac arrest. Do not touch or place any object near the ignition coil or connected ignition wire while the product is operating. It is possible to draw a spark from several inches away if the pilot bracket is not properly grounded.



Warning: Do not bypass any of the safety functions or modify any of the internal circuitry of the system. Doing so can lead to death, serious injury, electrocution, property damage, product damage and/or government fines.

2 DOCUMENT SCOPE

The Profire PF3100 is a modular combustion control system that can be customized and scaled to monitor and control a wide variety of industrial heating applications. The system is designed to ensure safe burner ignition and reliable process temperature control while supporting applications requiring ionization and/or UV flame detection, peripheral input device monitoring, fuel-air ratio control and oxygen trim. Configuration of the system is performed through the user interface module which also provides real-time status, state and alert information.

This document outlines the information required to design, commission, install and maintain a PF3100 system. Included are the ratings and input/output capabilities of each PF3100 card, the PF3100 system states and operating sequence, Installation instruction and diagrams, commissioning and maintenance procedures and additional information pertaining to use and functionality of a PF3100 system.

The information contained in this document applies to PF3100 cards with the hardware and firmware versions listed below:

PF3100 Card	Hardware Version	Firmware Version
PF3100-00 UI Card	v1.3.x	NA-43.3
PF3101-00 BMS Controller Card	v1.3.x	NA-43.3
PF3102-00 Ion Pilot Card	v2.2.x	NA-43.3
PF3102-01 UV Pilot Card	v1.0.x	NA-43.3
PF3102-03 Pilot Spark Card	v1.1.x	Not applicable
PF3103-00 Temperature Card	v1.4.x	NA-43.3
PF3106-00 Network Card	v2.1.x	Not applicable
PF3107-00 Modbus Card	v1.3.x	NA-43.3
PF3113-00 I/O Expansion Card	v2.0.x	NA-43.3

The hardware version is printed on the bottom line of the serial number label affixed to each card, while the firmware version can be found using the [Network Discovery tool](#) (System Screen > Config Tab > Diagnostics). Note that all connected cards must be running the same version of firmware for the system to operate correctly.







2.1 ADDITIONAL DOCUMENTATION

Visit the [Profire Documentation Website](#) for additional PF3100 documents, or to access archived documentation. [Contact Profire](#) for Appendix A: Functional Safety design for additional functional safety information required for IEC 61511 analysis.

3 APPROVALS AND RATINGS

3.1 CERTIFICATIONS

The following matrix identifies the PF3100 equipment and cards that make up each model, as well as the applicable certifications for each.

Model	Enclosure Type					PF3100 Hardware								Certifications						
	UIX Enclosure	CTX Enclosure	AUX Enclosure	EPX Enclosure	TLX Enclosure	PF3100-00 UI Card	PF3101-00 BMS Controller Card	PF3102-00 Ion Pilot Card	PF3102-01 UV Pilot Card	PF3102-03 Pilot Spark Card	PF3103-00 Temperature Card	PF3106-00 Network Switch Card	PF3107-00 Modbus Comm Card	PF3113-00 I/O Expansion Card	IEC 61508: 2010 Parts 1-7 (SIL 2)	UL 60730-2-5:2014 Ed.3 CSA C22.2#60730-2-5 :2014 Ed.1 ANSI Z21.20:2014 Ed.1	UL 61010-1:2012 Ed.3+R:29Apr2016 CSA C22.2#61010-1-12:2012 Ed.3	Class I, Div. 2, GRP ABCD; T4	Class I, Div. 1, GRP BCD; T4	Class I, Div. 1, GRP BCD, T6, IP66, 4X Class I, Zone 1 AExd IIB+H2 T6 Gb, IP66 Ex d IIB+H2 T6 Gb, IP66
PF3100-00						•														
PF3100-00A	•					•									•	• ¹				
PF3100-00B	•					•						•			•	• ¹		•		
PF3100-00C	•					•	•								•	• ²		•		
PF3100-00D	•					•	•					•			•	• ²		•		
PF3100-00E	•					•	•	•							•	•		•		
PF3100-00J	•					•						•			•	• ¹		•		
PF3100-00K	•					•	•					•			•	• ²		•		
PF3100-00T	•					•					•	•			•	• ¹		•		
PF3100-00U	•					•	•				•				•	• ²		•		
PF3101-00							•								•	• ²				
PF3101-00A		•					•								•	• ²		•		
PF3101-00B		•					•				•				•	• ²		•		
PF3102-00								•							•	• ³				
PF3102-00A				•				•							•	• ³				•
PF3102-01									•						•	• ⁴	• ⁹			
PF3102-03										•					•	• ⁴	• ⁹			
PF3103-00											•				•	• ¹				
PF3103-00D					•						•				•	• ¹		•		
PF3106-00											•				•	• ¹				
PF3106-00A			•								•				•	• ¹		•		
PF3107-00												•			•	• ¹				
PF3107-00A			•									•			•	• ¹		•		
PF3113-00													•		•	• ⁴	• ⁹			

¹ must be installed with a PF3101-00x card/module and a PF3102-00x card/module to maintain compliance.

² must be installed with a PF3102-00x Ion Pilot card/module to maintain compliance.

³ must be installed with a PF3101-00x BMS Controller card/module to maintain compliance.

⁴ Evaluation must be conducted following installation to verify compliance.

⁵ Refer to Appendix A: Functional Safety Design for details - available upon request.

⁶ In accordance with ISA 12.12.01:2015 Ed.6 • CSA C22.2#213:2016 Ed.2

⁷ In accordance with ISA 12.12.01:2015 Ed.6 • CSA C22.2#213:2016 Ed.2 • CSA C22.2#30:1986 Ed.3+G1;G2 • UL 1203:2013 Ed.5 +R:16Oct2018

⁸ In accordance with ANSI/ISA 60079-1:091 • ANSI/UL 1203 - 2013 • CAN/CSA-C22.2 No. 60079-1:11

⁹ Certified as a recognized component.

3.2 PRODUCT DECLARATIONS

System Parameter	Declared Value
Maximum Ionization Flame Failure Lock-Out Time	4 seconds
Maximum UV Flame Failure Lock-Out Time	4 seconds
Maximum Ignition Time	10 seconds
Maximum Pilot-Flame Establishing Period	10 seconds
Maximum Main-Flame Establishing Period	10 seconds
Minimum Pre-Purge Time	10 seconds
Minimum Post-Purge Time	10 seconds
Minimum Recycle Time	10 seconds
Maximum Start-up Lock-Out Time	10 seconds
Maximum Number of Start-up Retries	3
Maximum number of BMS Controller cards per UI card	16
Maximum number of BMS Controller cards per appliance	16
Maximum number of Pilot cards per BMS Controller card	4
Maximum number of Temperature cards per BMS Controller card	5
Maximum number of IO Expansion cards per BMS Controller card	5
Maximum number of Temperature inputs per appliance	20
Maximum number of I/O Expansion inputs per appliance	45

3.3 PRODUCT SPECIFICATIONS

System Parameter	Rating	
	12V Mode	24V Mode
Voltage Range	10.2 to 16.2 V _{DC}	20.4 to 32.4 V _{DC}
PF3100-00 UI Card Power Consumption (with USB)	5.5 W	5.5 W
PF3101-00 BMS Card Power Consumption (with LED board)	2.1 W	2.6 W
PF3102-00 Ion Pilot Card Power Consumption	1.7 W	1.8 W
PF3102-01 UV Pilot Card Power Consumption	1.1 W	1.0 W
PF3102-03 Pilot Spark Card Power Consumption (Peak while sparking)	2.1 W	11.9 W
PF3103-00 Temperature Card Power Consumption	1.0 W	1.0 W
PF3106-00 Network Card Power Consumption	0.6 W	0.6 W
PF3107-00 Modbus Card Power Consumption	1.3 W	1.3 W
PF3113-00 I/O Expansion Card Power Consumption	1.2 W	1.4 W
Operating and Storage Temperature	-40°C to 55°C (-40°F to 131°F)	

PF3100 Electromagnetic Field Immunity has been verified in accordance with IEC 61000-4-3:2010 and IEC 61000-4-6:2010.

3.4 ENCLOSURE SPECIFICATIONS

	UIX/CTX/AUX Enclosure	EPX Enclosure	TLX Enclosure
Material	Polyester painted steel	Aluminum	Aluminum
Conduit Entry	<u>UIX, CTX and AUX:</u> 4 x ¾" pre-cut, bottom entry 4 x ½" pre-cut, bottom entry <u>UIX and CTX only:</u> 1 x ½" keyed, pre-cut, side entry	4 x ¾" NPT	3 x ¾" NPT 1 x ½" NPT
Mounting	Channel bar or direct mount	Channel bar or direct mount	½" NPT thermowell
Type	4	4X	4X
Ingress Protection	IP66	IP66	IP66
Operating/Storage Temperature	-40°C to 55°C (-40°F to 131°F)	-40°C to 60°C (-40°F to 140°F)	-40°C to 55°C (-40°F to 131°F)

3.4.1 ENCLOSURE DIMENSIONS

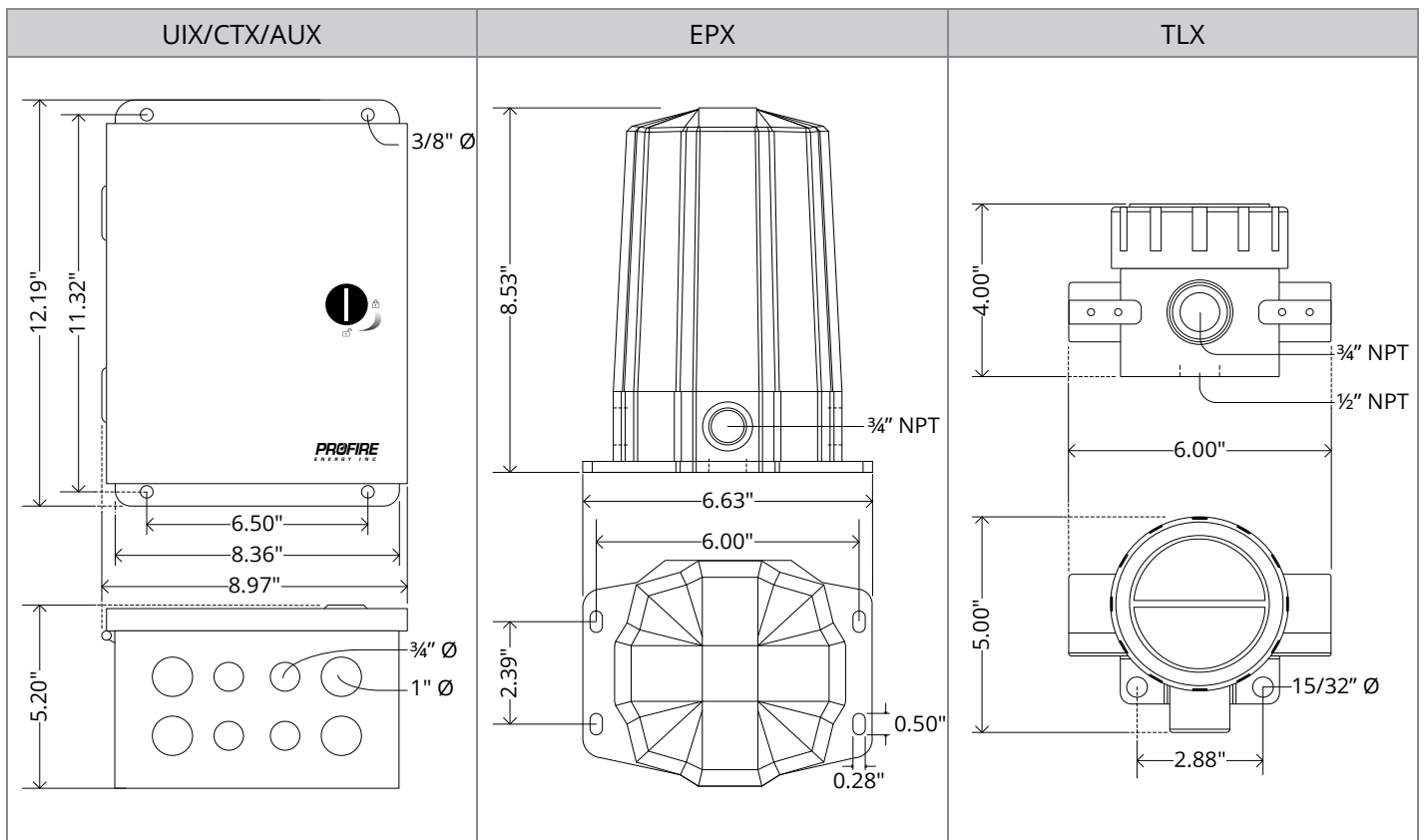

4 PF3100-00 USER INTERFACE CARD

The PF3100 User Interface card is the primary access point for commissioning and monitoring the PF3100 system. It consists of a 5.7" color display and a full keypad for navigation and configuration, as well as an appliance status LED indicator and a USB port for data logging and settings file management.

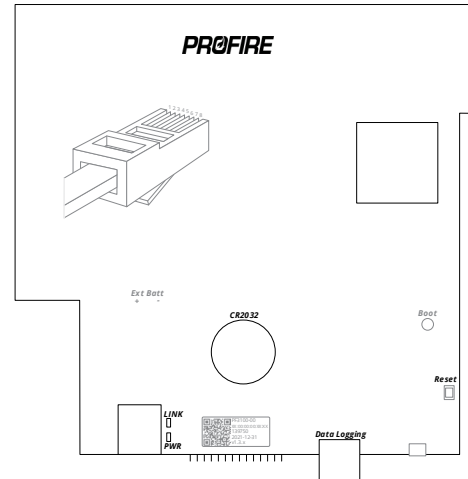
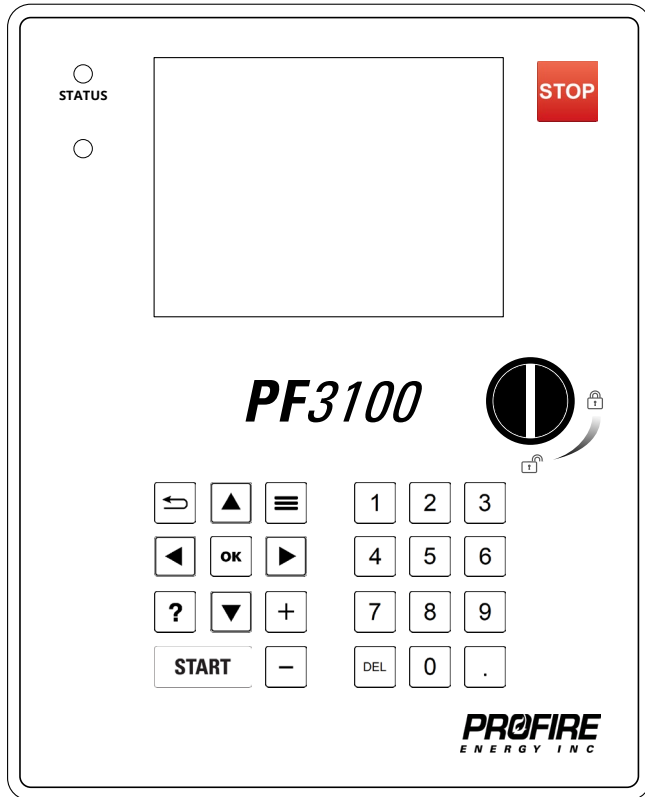

4.1 TERMINAL RATINGS

Name	Safety Rated	Input/Output	Electrical Ratings
PFRN Controller Network	Yes	I/O	Power consumer: 36 V _{DC} , 1A maximum
USB Port	No	I/O	5V, 500mA maximum
SD Card Port	No	I/O	N/A
Battery	No	I	3V, 225mAh
Keypad	No	I	N/A

4.2 KEYPAD

4.2.1 DETAILS

Terminals	14-pin connector on bottom of UI card
-----------	---------------------------------------

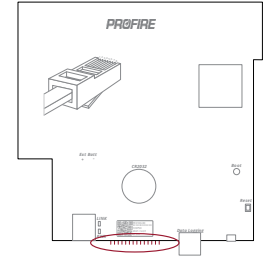
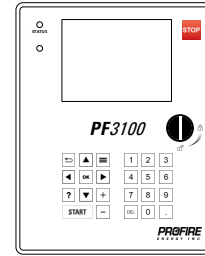

4.2.2 KEYPAD FUNCTIONALITY

Button	Description
	Stop a single controller ¹
	Stop a single appliance ¹
	Stop all appliances ¹
	Return to previous screen
	Bring up Appliance Quick Adjust menu
	Bring up Flame Diagnostics menu from the Controller Status screen
	Bring up multi-controller settings menu while adjusting settings
	Save a screenshot to a connected USB storage device (hold down)
	Toggles between Table and Graph view when configuring FARC channels.
	Select a highlighted item
	Displays configuration options of password protected drop-down settings.
	Make incremental changes to numeric settings
	Make incremental changes on Quick Adjust menu
	Scroll full pages of information (Event log, Controller Status Screen, etc.)
	Navigate menus and highlight items
	Start a single controller from the Ready state
	Start a single appliance when all associated controllers are in the Ready state
	Start all appliances when all controllers are in the Ready state
	Change numeric settings Delete key can also be used to unassign items in the configuration wizards.

¹ The keypad is intended to aid in commissioning and system navigation and must not be incorporated into any safety function. If user shutdown is a required safety function, then the BMS Controller card ESD input(s) or external ignition switch(es) must be used.

4.3 USER INTERFACE DISPLAY





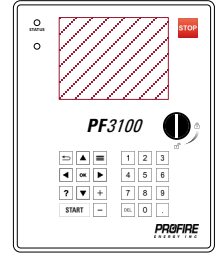



4.3.1 DETAILS

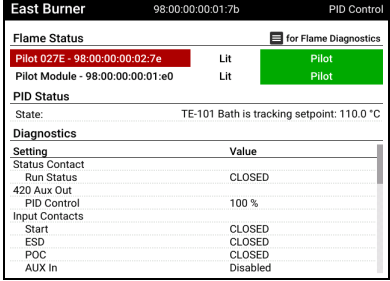



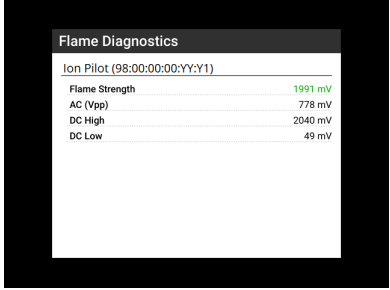

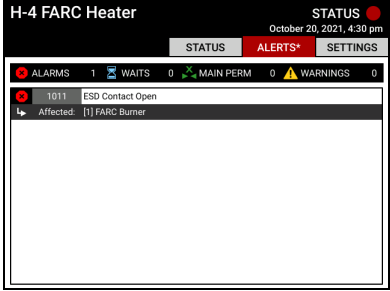

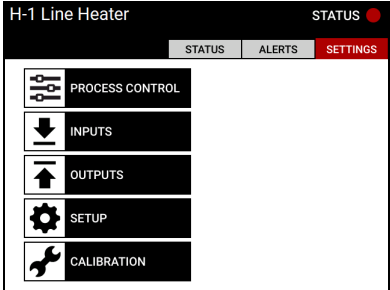

Type	Transmissive color TFT-LCD
Size	5.7"
Resolution	640 x 480

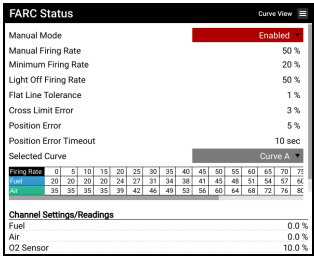



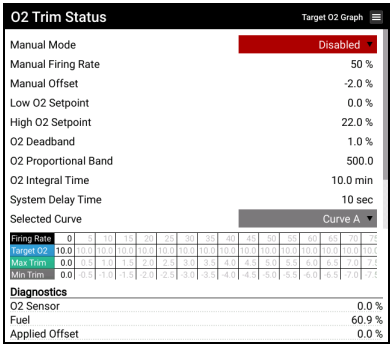

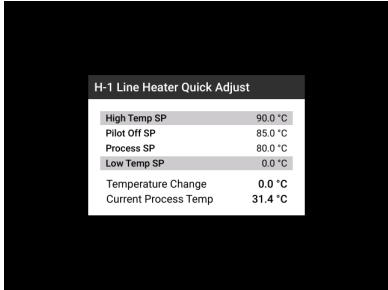

4.3.2 PF3100 STATUS AND CONFIGURATION SCREENS

Screen Name	Screenshot	Navigation	Description
System Screen - Status Tab		Press repeatedly from any screen.	Displays all the configured appliances as well as their current state and process temperature.
System Screen - Config Tab		From the System Status Tab, press . press to highlight desired option, then press to launch.	Provides access to configuration wizards, system diagnostics, data logging tools, settings file management utilities and a firmware update tool.
Appliance Screen - Status Tab		From System Status Tab, press to highlight desired appliance, then press .	Displays the temperature readings, input readings and output signals for the selected appliance as well as the current state of every BMS controller in the appliance.

Screen Name	Screenshot	Navigation	Description																				
<p>Controller Status Screen</p>	 <table border="1" data-bbox="391 516 768 659"> <thead> <tr> <th>Setting</th> <th>Value</th> </tr> </thead> <tbody> <tr> <td>Status Contact</td> <td></td> </tr> <tr> <td>Run Status</td> <td>CLOSED</td> </tr> <tr> <td>420 Aux Out</td> <td></td> </tr> <tr> <td>PID Control</td> <td>100 %</td> </tr> <tr> <td>Input Contacts</td> <td></td> </tr> <tr> <td>Start</td> <td>CLOSED</td> </tr> <tr> <td>ESD</td> <td>CLOSED</td> </tr> <tr> <td>POC</td> <td>CLOSED</td> </tr> <tr> <td>AUX In</td> <td>Disabled</td> </tr> </tbody> </table>	Setting	Value	Status Contact		Run Status	CLOSED	420 Aux Out		PID Control	100 %	Input Contacts		Start	CLOSED	ESD	CLOSED	POC	CLOSED	AUX In	Disabled	<p>From Appliance Status Tab, press  and  to highlight desired controller, then press .</p>	<p>Displays detailed information for all inputs and outputs of the selected controller and connected cards.</p>
Setting	Value																						
Status Contact																							
Run Status	CLOSED																						
420 Aux Out																							
PID Control	100 %																						
Input Contacts																							
Start	CLOSED																						
ESD	CLOSED																						
POC	CLOSED																						
AUX In	Disabled																						
<p>Flame Diagnostics Screen</p>		<p>From Controller Status Screen, press .</p>	<p>Displays flame strength readings for each Pilot card. Green indicates a strong flame, orange indicates a weak flame and red indicates a poor flame.</p>																				
<p>Appliance Screen - Alerts Tab</p>		<p>From Appliance Status Tab, press .</p>	<p>Displays all active alerts (alarms, waits, warnings and main permissives) for the appliance. Pressing  on an alert displays additional troubleshooting details if available.</p>																				

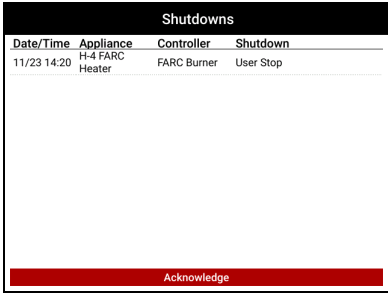
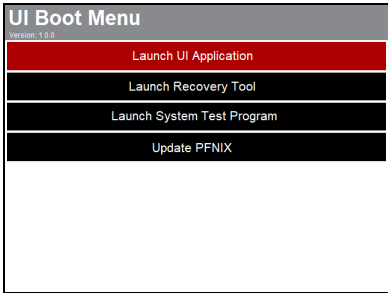
Screen Name	Screenshot	Navigation	Description
<p>Appliance Screen - Settings Tab</p>		<p>From Appliance Alerts Tab, press .</p>	<p>Contains configuration settings for all controllers in the appliance.</p>
<p>Appliance Screen - FARC Settings Dialog</p>		<p>From Appliance Status Tab, press  and  to highlight "FARC" option *, then press . Use  to toggle between Table View and Curve View.</p> <p>* This option is only visible when the FARC Enable setting (FARC/O₂ Trim Wizard > General Tab) is set to Enabled</p>	<p>Contains FARC table and additional tuning settings.</p>
<p>Appliance Screen - O₂ Trim Settings Dialog</p>		<p>From Appliance Status Tab, press  and  to highlight "O₂ Trim" option *, then press . Use  to cycle through Table and Graph views.</p> <p>* This option is only visible when the Trim Channel (FARC/O₂ Trim Wizard > O₂ Trim Tab) is not set to Disabled</p>	<p>Contains O₂ Trim tables and additional tuning settings.</p>

Screen Name	Screenshot	Navigation	Description
Quick Adjust Dialog		From System Screen or Appliance Screen, press  .	Allows for quick adjustment of the appliance Process Setpoint. Use  and  to make incremental adjustments.
Lockout Screen		N/A – Lockout Screen appears automatically upon controller lockout.	Displays important shutdown information upon a controller lockout. The screen persists until it is acknowledged by a user.
UI Boot Menu		From Power Off, press and hold  while powering up the UI. * It may take up to 30 seconds for the Boot Menu to appear.	Provides access to useful troubleshooting tools as well as utilities for updating the UI operating system. Contact Profire for instructions on how and when to use the Boot Menu utilities.

4.4 STATUS LED

4.4.1 DETAILS

Color	Green/Amber/Red
Indication	Appliance Run Status

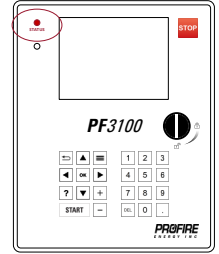

4.4.2 SYSTEM BEHAVIOR

Scenario	LED Color	LED Behavior
All appliances are stopped	Red	Solid
All appliances are running	Green	Solid
Some appliances are running and one or more are stopped	Green	Blinking
Status LED is malfunctioning Contact Profire	Amber	Any

4.5 PFRN CONTROLLER NETWORK PORT

4.5.1 DETAILS

PFRN Class	Interface
Type	Power consuming PFRN port
Connector type	8P8C

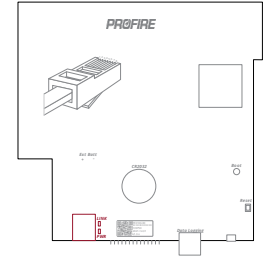

4.5.2 INTENDED FIELD DEVICE CONNECTIONS

Field Device	Configuration Requirements	Connection Diagrams
PF3101-00 BMS Controller card	N/A	8P8C PFRN Connector Wiring UI PFRN Connector Options
PF3101-00 BMS Controller card via PF3106-00 Network card		
PF3101-00 BMS Controller card via PF3107-00 Modbus card		

4.5.3 LED BEHAVIOR

Name	Color	LED Behavior	Interpretation	Corrective Action
Pwr	Blue	Off	Port has no power	Make sure connected power producer card (BMS controller card, Network card, Modbus card) is powered on. Check PFRN wire terminations
		On - Solid	Port has power	N/A
		On - Flickering	Port has intermittent power	Check PFRN wire terminations
Link	Green	Off	Port is not communicating	Check PFRN wire terminations
		On - Solid	Port is communicating normally	N/A
		On - Flickering		

4.6 USB PORT



Warning: Do not remove or install a USB stick unless the area is known to be non-hazardous.

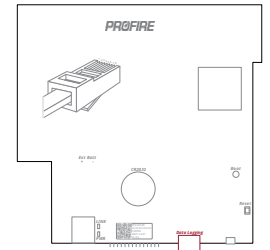

4.6.1 DETAILS

Recommended Capacity	1 GB
Recommended Operating Rating	-40°C – 60°C (-40°F – 140°F)

4.6.2 USB FUNCTIONALITY

Function	Procedure
Save controller settings to USB drive	Use the Backup tool to save settings to a USB drive.
Load controller settings from USB drive	Use the Restore tool to load settings to a USB drive.
Update card firmware	Use the Firmware Update tool to modify the firmware of a connected card.
Export event log	Use the Event Logging and Export tools to view and save system events.
Export data log	Use the Data Logging and Export tools to trend and save system data.

4.7 SD CARD SLOT



Warning: Do not remove or install the SD card unless the area is known to be non-hazardous.

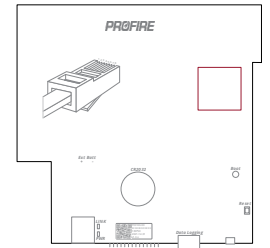

4.7.1 DETAILS

Recommended Size	Standard or mini/micro with adapter
Recommended Capacity	8GB

4.7.2 SD CARD FUNCTIONALITY

Function	Procedure
Update UI operating system (PFnix)	UI Boot Menu > Update PFnix Contact Profire for approved PFnix update file and update procedure. * This is different than a firmware update. For UI firmware update procedure refer to Firmware Update section.

4.8 BATTERY



Do not remove or install the battery unless the area is known to be non-hazardous.

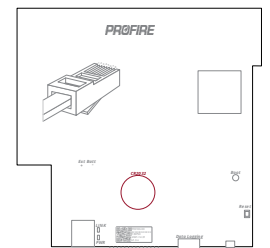

4.8.1 DETAILS

Voltage	3V
Type	CR 2032

5 PF3101-00 BMS CONTROLLER CARD

The BMS Controller card is the dedicated hub for all I/O cards and instrumentation associated with a specific burner in an appliance. All inputs are monitored by the BMS to identify shutdown conditions and to determine safety output behavior and state transitions.

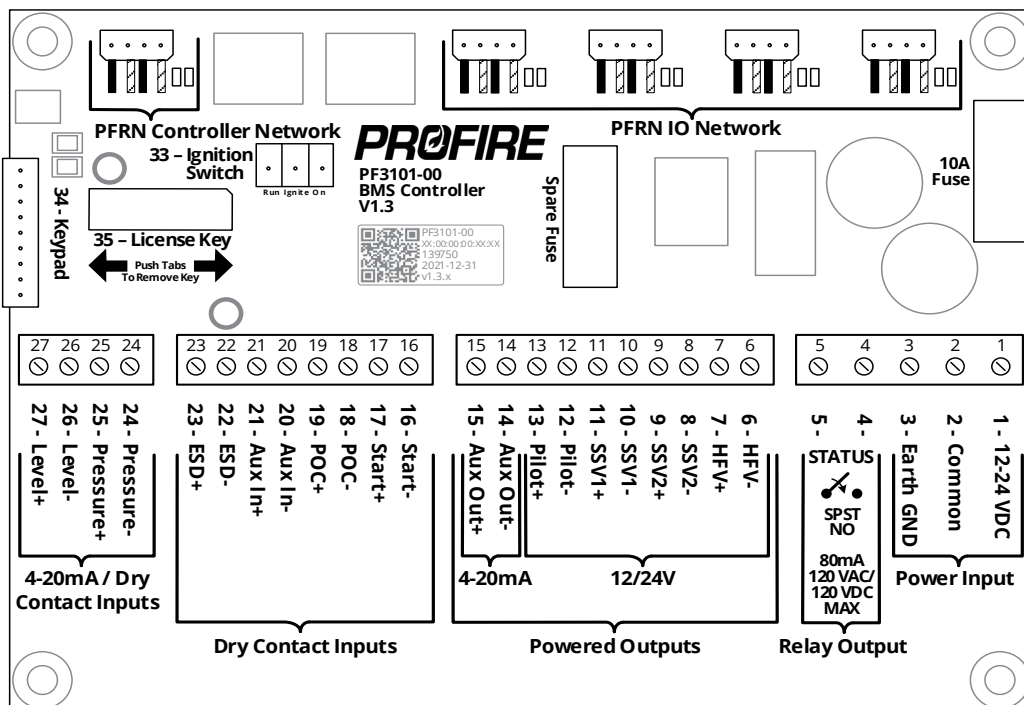
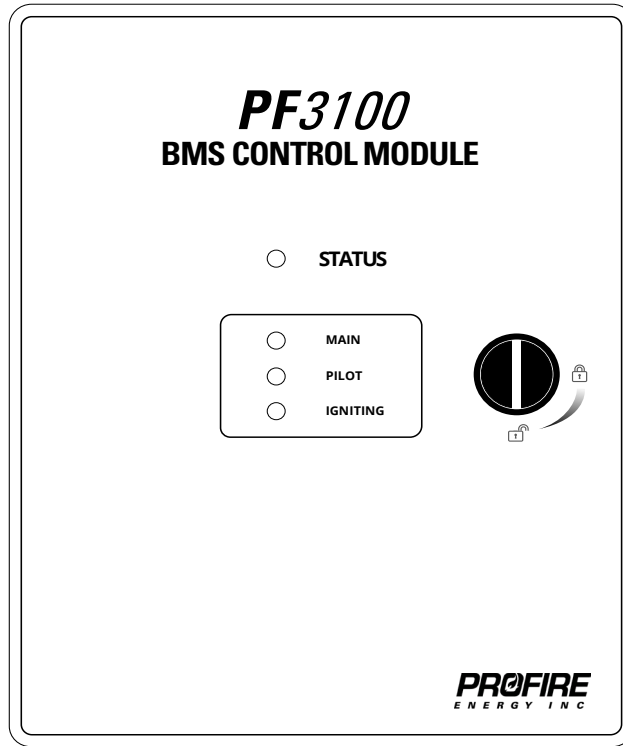

5.1 TERMINAL RATINGS

Name	Safety Rated	Terminal		Input/Output	Electrical Ratings
Power Input	No	1	12-24 VDC	I	12-24 V _{DC} 10A maximum
		2	Common		
		3	Earth GND	GND	*Fused at 10A
Relay Output	No	4	STATUS A	-	Dry contact 120 V _{AC} /V _{DC} 80mA maximum
		5	STATUS B		
HFV	No	6	-	O	
		7	+		
SSV2	Yes	8	-	O	12-24 V _{DC} 2A maximum
		9	+		
SSV1	Yes	10	-	O	Pulsed Output with configurable PWM Expected Load: Inductive/Resistive
		11	+		
Pilot	Yes	12	-	O	
		13	+		
Aux Out	No	14	-	O	12-24 V _{DC} 20mA maximum Maximum output device impedance: 12V Mode: 250Ω, 24V Mode: 900Ω
		15	+		
Start	Yes	16	-	I	30 V _{DC} max, 2mA minimum wetting current
		17	+	O	12-24 V _{DC} , 100mA maximum ¹
POC	Yes	18	-	I	30 V _{DC} max, 2mA minimum wetting current
		19	+	O	12-24 V _{DC} , 100mA maximum ¹
Aux In	Yes	20	-	I	30 V _{DC} max, 2mA minimum wetting current
		21	+	O	12-24 V _{DC} , 100mA maximum ¹
ESD	Yes	22	-	I	30 V _{DC} max, 2mA minimum wetting current
		23	+	O	12-24 V _{DC} , 100mA maximum ¹
Pressure	Yes	24	-	I	Digital Mode: 30 V _{DC} max, 2mA minimum wetting current 4-20 Mode: 30 V _{DC} max, 25mA maximum Input resistance ~200Ω
		25	+	O	12-24 V _{DC} , 50mA maximum,
Level	Yes	26	-	I	Digital Mode: 30 V _{DC} max, 2mA minimum wetting current 4-20 Mode: 30 V _{DC} max, 25mA maximum Input resistance ~200Ω
		27	+	O	12-24 V _{DC} , 50mA maximum,
PFRN Controller Network	Yes	28		I/O	36 V _{DC} 1A maximum
PFRN I/O Network	Yes	29		I/O	36 V _{DC} 1A maximum
		30		I/O	
		31		I/O	
		32		I/O	
Ignition Switch	Yes	33	Run	I	3.3 V _{DC}
			Ignite	I	
			On	O	3.3 V _{DC}
Keypad	No	34		O	3.3 V _{DC}
License Key	No	35		I	3.3 V _{DC}

¹ The combined current requirements of the Start, POC, Aux In and ESD input devices cannot exceed 100mA.

5.2 CONTROLLER POWER INPUT

5.2.1 DETAILS

Terminals	1, 2 & 3
Name	Power Input
Type	BMS power input
Fuse	10A ceramic, Contact Profire for replacements

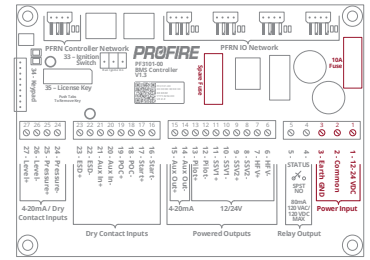

5.2.2 INTENDED FIELD DEVICE CONNECTIONS

Field Device	Configuration Requirements	Connection Diagrams
12V Power Supply	Controller Settings > Setup > System Voltage Controller Voltage: 12V Voltage Restart: As desired	Power Input Wiring
24V Power Supply	Controller Settings > Setup > System Voltage Controller Voltage: 24V Voltage Restart: As desired	

5.2.3 VOLTAGE ALERT BEHAVIOR - 12V MODE

System Voltage	Scenario			State Transition	Controller Alerts
	Low Voltage Restart	High Voltage Restart	Controller State		
Below 9.6V *	Enabled	Any	Any running state	Waiting	Low Voltage Wait
	Enabled	Any	Any stopped state	No effect	Low Voltage Wait
Below 9.6V *	Disabled	Any	Any running state	Lockout	Low Voltage Alarm
	Disabled	Any	Any stopped state	Alarm	Low Voltage Alarm
Between 9.6V and 9.9V *	Any	Any	Any	No effect	Low Voltage Warning
Between 9.9V and 16.1V *	Any	Any	Any	No effect	N/A
Between 16.1V and 16.8V *	Any	Any	Any	No effect	High Voltage Warning
Above 16.8V *	Any	Enabled	Any running state	Waiting	High Voltage Wait
			Any stopped state	No effect	High Voltage Wait
	Any	Disabled	Any running state	Lockout	High Voltage Alarm
			Any stopped state	Alarm	High Voltage Alarm

* All listed voltage thresholds are +/- 1.0 V

5.2.4 VOLTAGE ALERT BEHAVIOR - 24V MODE

System Voltage	Scenario			State Transition	Controller Alerts
	Low Voltage Restart	High Voltage Restart	Controller State		
Below 19.2V *	Enabled	Any	Any running state	Waiting	Low Voltage Wait
	Enabled	Any	Any stopped state	No effect	Low Voltage Wait
Below 19.2V *	Disabled	Any	Any running state	Lockout	Low Voltage Alarm
	Disabled	Any	Any stopped state	Alarm	Low Voltage Alarm
Between 19.2V and 19.9V *	Any	Any	Any	No effect	Low Voltage Warning
Between 19.9V and 33.1V *	Any	Any	Any	No effect	N/A
Between 33.1V and 33.6V *	Any	Any	Any	No effect	High Voltage Warning
Above 33.6V *	Any	Enabled	Any running state	Waiting	High Voltage Wait
			Any stopped state	No effect	High Voltage Wait
	Any	Disabled	Any running state	Lockout	High Voltage Alarm
			Any stopped state	Alarm	High Voltage Alarm

* All listed voltage thresholds are +/- 1.0 V

5.3 STATUS CONTACT

5.3.1 DETAILS

Terminals	4 & 5
Name	Relay Output
Type	Normally open dry contact

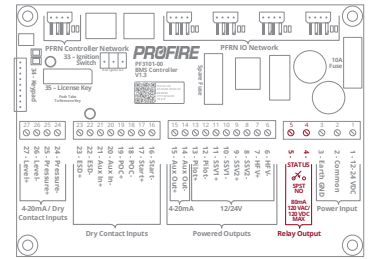

5.3.2 INTENDED FIELD DEVICE CONNECTIONS

Field Device	Configuration Requirements	Connection Diagrams
Site equipment status panel	Controller Settings > Outputs > Status Contact Status Contact Mode: As desired	Run Status - AC Run Status - DC
Tank pump motor enable via relay	Controller Settings > Outputs > Status Contact Status Contact Mode: High Level/Flow	Run Status - Pump Control

5.3.3 STATUS CONTACT BEHAVIOR BY CONTROLLER STATE

Status Contact Mode Setting	Condition	Lockout	Alarm	Ready	Waiting	Startup Checks	Proven Pre-Purge	Ignition	Pilot	Low Fire	Process Control
Run Status	Any	O	O	O	C	C	C	C	C	C	C
Run and Start Status	Start contact open	O	O	O	O	-	-	-	-	-	-
	Start contact closed	O	O	O	C	C	C	C	C	C	C
Heating Status	Any	O	O	O	O	O	O	C	C	C	C
Pilot Flame Monitor	flame quality < 50%	O	O	O	O	O	O	O	O	O	O
	flame quality > 50%	O	O	O	C	C	C	C	C	C	C
Low Temp Warning	Process temp < Low temp	O	O	O	O	O	O	O	O	O	O
	Process temp > Low temp	O	O	O	C	C	C	C	C	C	C
High Level/Flow	Level > High Trip	O	O	O	O	O	O	O	O	O	O
	Level < High Trip	O	O	O	C	C	C	C	C	C	C

O – Open, C- Closed

5.4 HIGH FIRE VALVE SOLENOID OUTPUT

5.4.1 DETAILS

Terminals	6 & 7
Name	HFV
Alternate Name	Fan Output
Type	Powered solenoid output with configurable PWM

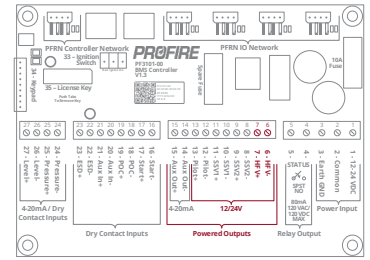

5.4.2 INTENDED FIELD DEVICE CONNECTIONS

Field Device	Configuration Requirements	Connection Diagrams
Normally closed gas shutoff valve – Peak and hold	Controller Settings > Outputs > Valves High Fire PWM: As desired HFV Output Mode: Valve	Solenoid Output – 12V/24V
Normally closed gas shutoff valve – Constant current	Controller Settings > Outputs > Valves High Fire PWM: 100% HFV Output Mode: Valve	Solenoid Output – 12V/24V
Forced draft fan motor enable via relay	Controller Settings > Outputs > Valves High Fire PWM: 100% HFV Output Mode: Forced Draft Fan	HFV Output – Fan Control Wiring
Purge fan enable via relay	Controller Settings > Outputs > Valves High Fire PWM: 100% HFV Output Mode: Purge Fan	HFV Output – Fan Control Wiring
Not Used	N/A	N/A

5.4.3 HFV OUTPUT BEHAVIOR BY CONTROLLER STATE

HFV Output Mode Setting	Condition	Power On	Lockout	Alarm	Ready	Waiting	Startup Checks	Proven Pre-Purge	Ignition	Pilot	Low Fire	Process Control - High Fire	Process Control - PID Control	Process Control - Incinerate	Process Control - Incinerate No Assist
Valve	Any	D	D	D	D	D	-	-	D	D	D	E	E	D	D
Forced Draft Fan	Not Purging	D	D	D	D	D	D	-	E	E	E	-	E	-	-
	Purging	E	E	E	E	E	-	E	-	-	-	-	-	-	-
Purge Fan	Not Purging	D	D	D	D	D	D	-	D	D	D	-	D	D	D
	Purging	E	E	E	E	E	-	E	-	-	-	-	-	-	-

E = Energized, D = De-energized

5.5 MAIN VALVE SOLENOID OUTPUT 2

5.5.1 DETAILS

Terminals	8 & 9
Name	SSV2
Alternate Name	Incinerator Waste Gas Valve
Type	Powered solenoid output with configurable PWM

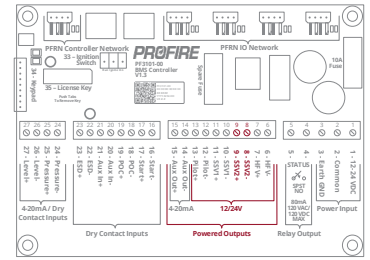

5.5.2 INTENDED FIELD DEVICE CONNECTIONS

Field Device	Configuration Requirements	Connection Diagrams
Normally closed main gas shutoff valve – Peak and hold	Controller Settings > Outputs > Valves SSV2 PWM: As desired	Solenoid Output – 12V/24V
Normally closed main gas shutoff valve – Constant current	Controller Settings > Outputs > Valves SSV2 PWM: 100%	Solenoid Output – 12V/24V
Normally closed incinerator waste gas shutoff valve	Controller Settings > Outputs > Valves SSV2 PWM: As above Controller Settings > Process Control > Incinerator Control Incinerator Enable: Enabled	Solenoid Output – 12V/24V

5.5.3 SSV2 OUTPUT BEHAVIOR BY CONTROLLER STATE

Incinerator Enable Setting	Power On	Lockout	Alarm	Ready	Waiting	Startup Checks	Proven Pre-Purge	Ignition	Pilot	Low Fire	Process Control – High Fire	Process Control – PID Control	Process Control - Incinerate	Process Control - Incinerate No Assist
Disabled	D	D	D	D	D	D	D	D	D	E	E	E	-	-
Enabled	D	D	D	D	D	-	-	D	D	D	-	-	E	E

E = Energized, D = De-energized

5.6 MAIN VALVE SOLENOID OUTPUT 1

5.6.1 DETAILS

Terminals	10 & 11
Name	SSV1
Alternate Name	Incinerator Assist Gas Valve
Type	Powered solenoid output with configurable PWM

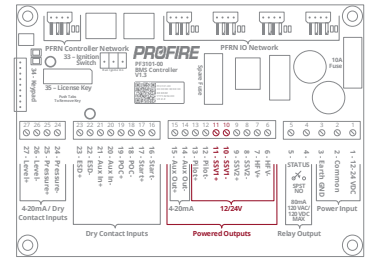

5.6.2 INTENDED FIELD DEVICE CONNECTIONS

Field Device	Configuration Requirements	Connection Diagrams
Normally closed main gas shutoff valve – Peak and hold	Controller Settings > Outputs > Valves SSV1 PWM: As desired	Solenoid Output – 12V/24V
Normally closed main gas shutoff valve – Constant current	Controller Settings > Outputs > Valves SSV1 PWM: 100%	Solenoid Output – 12V/24V
Normally closed incinerator assist gas shutoff valve	Controller Settings > Outputs > Valves SSV1 PWM: As above Controller Settings > Process Control > Incinerator Control Incinerator Enable: Enabled	Solenoid Output – 12V/24V

5.6.3 SSV1 OUTPUT BEHAVIOR BY CONTROLLER STATE

Incinerator Enable Setting	Power On	Lockout	Alarm	Ready	Waiting	Startup Checks	Proven Pre-Purge	Ignition	Pilot	Low Fire	Process Control - High Fire	Process Control – PID Control	Process Control - Incinerate	Process Control - Incinerate No Assist
Disabled	D	D	D	D	D	D	D	D	D	E	E	E	-	-
Enabled	D	D	D	D	D	-	-	D	D	E	-	-	E	D

E = Energized, D = De-energized

5.7 PILOT VALVE SOLENOID OUTPUT

5.7.1 DETAILS

Terminals	12 & 13
Name	Pilot
Type	Powered solenoid output with configurable PWM

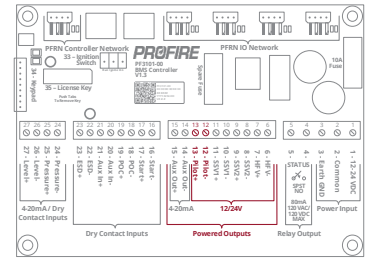

5.7.2 INTENDED FIELD DEVICE CONNECTIONS

Field Device	Configuration Requirements	Connection Diagrams
Normally closed gas shutoff valve – Peak and hold	<p>Controller Settings > Outputs > Valves Pilot Valve PWM: As desired</p> <p>Controller Settings > Process Control > Process Temp Control Pilot Off Mode: As desired</p> <p>Controller Settings > Inputs > Flame Detection Main Flame Detect: As desired</p>	Solenoid Output – 12V/24V
Normally closed gas shutoff valve – Constant current	<p>Controller Settings > Outputs > Valves Pilot Valve PWM: 100%</p> <p>Controller Settings > Process Control > Process Temp Control Pilot Off Mode: As desired</p> <p>Controller Settings > Inputs > Flame Detection Main Flame Detect: As desired</p>	Solenoid Output – 12V/24V

5.7.3 PILOT OUTPUT BEHAVIOR BY CONTROLLER STATE

Pilot Off Mode Setting	Power On	Lockout	Alarm	Ready	Waiting	Startup Checks	Proven Pre-Purge	Ignition	Pilot	Low Fire	Process Control
Disabled	D	D	D	D	D	D	D	E	E	E	E
Off at Setpoint	D	D	D	D	D	D	D	E	E	D ^{2,3}	D ^{2,3}
Follow Main	D	D	D	D	D	D	D	E	E	D ^{2,3}	D ^{2,3}
Off after Main On	D	D	D	D	D	D	D	E	E	D ^{2,3}	D ^{2,3}

¹ E = Energized, D = De-energized

² Main Flame Detect setting must be enabled

³ Energized under reignition conditions in accordance with configured Pilot Relight Mode and Pilot Relight Timeout settings (Controller Settings > Outputs > Ignition).

5.8 AUXILIARY 4-20mA OUTPUT

5.8.1 DETAILS

Terminals	14 & 15
Name	Aux Out
Type	4-20mA powered output

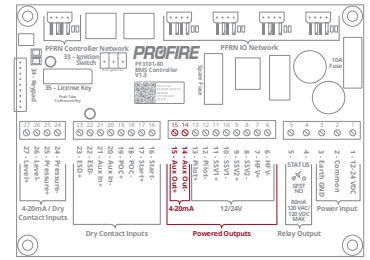

5.8.2 INTENDED FIELD DEVICE CONNECTIONS

Field Device/Application	Configuration Requirements	Connection Diagrams
4-20mA proportional fuel gas valve using internal PID algorithm	<p>Controller Settings > Process Control > Process Temp Control Low Fire Mode: Not disabled</p> <p>Controller Settings > Process Control > Cold Start Ramping All settings: As desired</p> <p>Controller Settings > Outputs > 4-20 Aux Out 4-20 Aux Out Mode: PID Control Manual Override: Disabled All other settings: As desired</p> <p>FARC Settings (If applicable) Off Position: As desired Light Off Position: As desired</p>	Proportional Valve/Actuator Wiring
4-20mA proportional fuel gas valve using external firing rate input	<p>Same as previous with the following exceptions:</p> <p>Controller Settings > Outputs > 4-20 Aux Out 4-20 Aux Out Mode: Appliance Firing Rate</p> <p>I/O Wizard > Add Inputs Tab Input Type: Appliance Firing Rate</p>	Proportional Valve/Actuator Wiring
4-20mA proportional fuel gas valve using Primary and Secondary PID control.	<p>I/O Wizard > Create Inputs & I/O Modules Tabs Create a Secondary PID control input Create a PID staging input if required</p> <p>Controller Settings > Outputs > 4-20 Aux Out 4-20 Aux Out Mode: PID Control</p> <p>Controller Settings > Process Control > Secondary PID All settings: As desired per PID control preferences</p> <p>Controller Settings > Process Control > Advanced PID Cascaded PID: As required PID Staging Mode: As desired Secondary Input: Assign secondary PID input created above</p>	Proportional Valve/Actuator Wiring
4-20mA proportional fuel gas valve using cascaded Primary and Secondary PID control.	<p>Staging Input: Assign secondary PID input created above</p>	
4-20mA proportional fuel gas valve using a PID staging input in conjunction with Primary and Secondary PID control.	<p>Staging Input: Assign staging input created above if required All other settings: As desired</p> <p>Refer to PID Tuning Guide document for additional configuration details.</p>	
BMS input echo to PLC (Process temp, Pressure or Level/Flow)	<p>Controller Settings > Outputs > 4-20 Aux Out 4-20 Aux Out Mode: Desired Echo setting</p>	4-20mA Echo to PLC
Not Used	<p>Controller Settings > Outputs > 4-20 Aux Out 4-20 Aux Out Mode: Disabled</p>	N/A

5.8.3 AUXILIARY OUTPUT POSITION BY CONTROLLER STATE – PID CONTROL

4-20 Aux Out Mode Setting	FARC Enable setting	Power On	Lockout	Alarm	Ready	Waiting	Startup Checks	Request Purge Position	Prove Airflow	Pre-Purge	Request Pilot Position	Ignition	Pilot	Request Light Off Position	Low Fire	Process Control – High Fire	Process Control – PID Control	Process Control – Incinerate	Process Control – Incinerate No Assist
Disabled	Any	-	-	-	-	-	-	-	-	-	-	-	-	-	-	-	-	-	-
PID Control	Disabled	Purge Position					-	-	Purge Position	-	Pilot Position	-	-	Minimum Position	-	Variable position between			
	Enabled	Off Position					-	-	Purge Position	Pilot Position	-	Light Off	-		-	Minimum and 100% per PID algorithm			
Appliance Firing Rate	Disabled	Purge Position					-	-	Purge Position	-	Pilot Position	-	-		-	-	Variable position between		
	Enabled	Off Position					-	-	Purge Position	Pilot Position	-	Light Off	-	-	-	Minimum and 100% per firing rate input			

5.8.4 AUXILIARY OUTPUT BEHAVIOR BY CONTROLLER STATE – INPUT ECHO

4-20 Aux Out Mode Setting	Aux Out Behavior	Example
Process Temp Echo	Temperature input value is echoed out on the Aux output as a 4-20mA signal mapped against the configured High Temp setpoint.	<p>Controller Settings > Process Control > Process Temp Control High Temp SP: 100 °</p> <p>4mA output signal corresponds to a reading of 0 ° 20mA output signal corresponds to a reading of 100 °</p> <p>A temperature reading of 50 °, in this case, is represented as a 12mA Aux output signal.</p>
Fuel Pressure Echo	BMS input value is echoes out on the Aux output as an identical 4-20mA signal	An input of 12mA is represented as an identical 12mA Aux output signal.
Level/Flow Echo		

5.9 REMOTE START INPUT

5.9.1 DETAILS

Terminals	16 & 17
Name	Start
Type	Digital Input

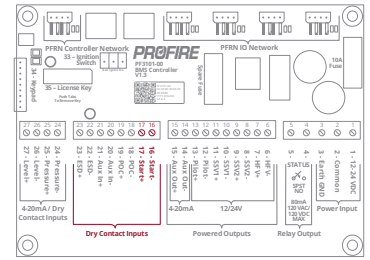

5.9.2 INTENDED FIELD DEVICE CONNECTIONS

Field Device	Configuration Requirements	Connection Diagrams
Remote control panel BMS start switch	N/A	Digital Input – Dry Contact Digital Input – Wet Contact
Start Signal from PLC	N/A	Digital Input – Dry Contact Digital Input – Wet Contact
Not Used	N/A	N/A - Install wire jumper between terminals 16 and 17

5.9.3 SYSTEM BEHAVIOR – REMOTE START INPUT

Scenario		State Transition	Controller Alerts
Start Input state	Controller State		
Energized	Any	No effect	N/A
De-energized	Any stopped	No effect	Start Contact Open wait
	Any running	Waiting	Start Contact Open wait
Energized to de-energized to energized within 30 seconds*	Lockout	Ready/Alarm	N/A
	Ready	Startup	N/A

* The system does not register an energized to de-energized to energized transition unless the input remains in each state for at least 500ms.

5.10 PROOF OF CLOSURE INPUT

5.10.1 DETAILS

Terminals	18 & 19
Name	POC
Type	Digital Input

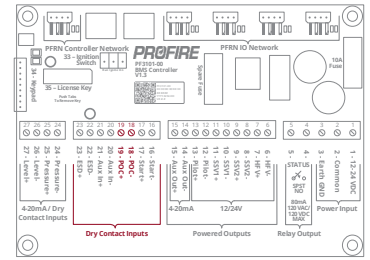

5.10.2 INTENDED FIELD DEVICE CONNECTIONS

Field Device	Configuration Requirements	Connection Diagrams
Main valve (SSV) proof of closure switch	Controller Settings > Inputs > Proof Of Closure Proof Of Closure: Enabled	Digital Input – Dry Contact Digital Input – Wet Contact
Incinerator assist gas valve (SSV1) proof of closure switch	Controller Settings > Process Control > Incinerator Control Incinerator Enable: Enabled Incinerator PoC Valve: Assist Controller Settings > Inputs > Proof Of Closure Proof Of Closure: Enabled	Digital Input – Dry Contact Digital Input – Wet Contact
Incinerator waste gas valve (SSV2) proof of closure switch	Controller Settings > Process Control > Incinerator Control Incinerator Enable: Enabled Incinerator PoC Valve: Waste Controller Settings > Inputs > Proof Of Closure Proof Of Closure: Enabled	Digital Input – Dry Contact Digital Input – Wet Contact
Not Used	Controller Settings > Inputs > Proof Of Closure Proof Of Closure: Disabled	N/A

5.10.3 SYSTEM BEHAVIOR – PROOF OF CLOSURE INPUT

System Configuration	Scenario		State Transition	Controller Alerts
	Controller State	POC Input		
Proof Of Closure: Disabled	Any	Any	No effect	N/A
Proof Of Closure: Enabled	Any non-main state	Energized	No effect	N/A
		De-energized	Lockout/Alarm	POC Contact Open alarm
Proof Of Closure: Enabled Incinerator Enable: Disabled	Any main fuel state	Energized	No effect	POC Contact Failed to Open warning
		De-energized	No effect	N/A
Proof Of Closure: Enabled Incinerator Enable: Enabled Incinerator PoC Valve: Waste	Low Fire	Energized	No effect	N/A
		De-energized	Lockout	POC Contact Open alarm
	Incinerate	Energized	No effect	POC Contact Failed to Open warning
		De-energized	No effect	N/A
	Incinerator No Assist	Energized	No effect	POC Contact Failed to Open warning
		De-energized	No effect	N/A
Proof Of Closure: Enabled Incinerator Enable: Enabled Incinerator PoC Valve: Assist	Low Fire	Energized	No effect	POC Contact Failed to Open warning
		De-energized	No effect	N/A
	Incinerate	Energized	No effect	POC Contact Failed to Open warning
		De-energized	No effect	N/A
	Incinerate No Assist	Energized	No effect	N/A
		De-energized	Lockout	POC Contact Open alarm

5.11 AUXILIARY INPUT

5.11.1 DETAILS

Terminals	20 & 21
Name	Aux In
Type	Digital Contact

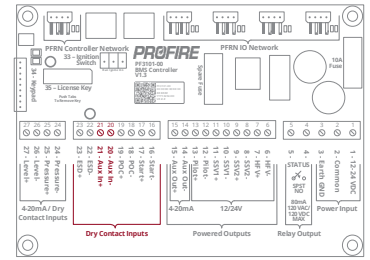

5.11.2 INTENDED FIELD DEVICE CONNECTIONS

Field Device	Configuration Requirements	Connection Diagrams
High Fire Valve (HFV) proof of closure switch	Controller Settings > Inputs > Aux In Contact Aux In Contact Mode: Proof of Low Fire	Digital Input – Dry Contact Digital Input – Wet Contact
Proof of low fire position switch on a main fuel temperature control valve		
Main valve (SSV) proof of closure switch	Controller Settings > Inputs > Aux In Contact Aux In Contact Mode: Proof of Closure 2 Controller Settings > Process Control > Incinerator Control Incinerator Enable: Disabled	Digital Input – Dry Contact Digital Input – Wet Contact
Incinerator waste gas valve (SSV2) proof of closure switch	Controller Settings > Inputs > Aux In Contact Aux In Contact Mode: Proof of Closure 2 Controller Settings > Process Control > Incinerator Control Incinerator Enable: Enabled	Digital Input – Dry Contact Digital Input – Wet Contact
Pilot valve proof of closure switch	Controller Settings > Inputs > Aux In Contact Aux In Contact Mode: Proof of Pilot	Digital Input – Dry Contact Digital Input – Wet Contact
Low fuel pressure switch	Controller Settings > Inputs > Aux In Contact Aux In Contact Mode: Low Fuel Pressure Main Permissive Masking: As desired Controller Settings > Inputs > Fuel Pressure Input Low Fuel Pressure Restart: As desired Restart Mode: As desired	Digital Input – Dry Contact Digital Input – Wet Contact
Proof of airflow switch	Controller Settings > Inputs > Aux In Contact Aux In Contact Mode: Proof of Airflow Controller Settings > Outputs > Valves HFV Output Mode: Forced Draft or Purge Fan FARC/O₂ Trim Wizard Configured as required by a fuel-air ratio control expert	Digital Input – Dry Contact Digital Input – Wet Contact
Main permissive switch	Controller Settings > Inputs > Aux In Contact Aux In Contact Mode: Main Permissive Main Permissive Masking: As desired	Digital Input – Dry Contact Digital Input – Wet Contact

5.11.3 SYSTEM BEHAVIOR – AUX IN PROOF OF LOW FIRE

Scenario		State transition	Controller Alerts
Controller State	Aux Input state		
Pilot or Incinerate No Assist	Energized	No effect	N/A
	De-energized	Lockout	POLF Contact Open alarm
Any other state	Any	No effect	N/A

5.11.4 SYSTEM BEHAVIOR – AUX IN PROOF OF CLOSURE 2

Scenario			State Transition	Controller Alerts
Incinerator Enable	Controller State	Aux Input State		
Any	Any non-main state	Energized	No effect	N/A
		De-energized	Lockout/Alarm	POC2 Contact Open alarm
Disabled	Any main fuel state	Energized	No effect	POC2 Contact Failed to Open warning
		De-energized	No effect	N/A
Enabled	Low Fire	Energized	No effect	N/A
		De-energized	Lockout	POC2 Contact Open alarm
	Incinerate	Energized	No effect	POC2 Contact Failed to Open warning
		De-energized	No effect	N/A
	Incinerator No Assist	Energized	No effect	POC2 Contact Failed to Open warning
		De-energized	No effect	N/A

5.11.5 SYSTEM BEHAVIOR – AUX IN PROOF OF PILOT

Scenario			State Transition	Controller Alerts
Pilot Off Mode Setting	Controller State	Aux Input State		
Off at setpoint or Follow Main	Any non-fuel state	Energized	No effect	N/A
		De-energized	Lockout/Alarm	POP Contact Open alarm
	Any fuel state	Energized	No effect	POP Contact Failed to Open warning
		De-energized	No effect	N/A
Off after main on	Any non-fuel state	Energized	No effect	N/A
		De-energized	Lockout/Alarm	POP Contact Open alarm
	Pilot	Energized	No effect	POP Contact Failed to Open warning
		De-energized	No effect	N/A
	Any main fuel state	Energized	No effect	N/A
		De-energized	Lockout	POP Contact Open Alarm

5.11.6 SYSTEM BEHAVIOR – AUX IN LOW FUEL PRESSURE

Scenario			State Transition	Controller Alerts
Settings Configuration	Controller State	Aux Input State		
Any	Any	Energized	No effect	N/A
Low Fuel Pressure Restart: Disabled	Any	De-energized	Lockout/Alarm	Low Fuel Pressure Dry Contact alarm
Low Fuel Pressure Restart: Enabled Restart Mode: Wait	Any stopped state	De-energized	No effect	Low Fuel Pressure Dry Contact wait ¹
	Any running state	De-energized	Waiting ¹	Low Fuel Pressure Dry Contact wait ¹
Low Fuel Pressure Restart: Enabled Restart Mode: Main Permissive	Any non-main state	De-energized	No effect	Aux In Low Fuel Pressure main permissive
	Any main fuel state	De-energized	Pilot ²	Aux In Low Fuel Pressure main permissive

¹ When Main Permissive Masking is Enabled and there is a main permissive alert present on the controller, the pressure wait is hidden and the controller remains in its current state.

² When Pilot Off mode is set to Off After Main On, the controller transitions to the Waiting state, then purges the system before reigniting and proceeding to Pilot.

5.11.7 SYSTEM BEHAVIOR – BMS CARD AUX IN PROOF OF AIRFLOW

Scenario			State Transition	Controller Alerts
HFV Output Mode Setting	Controller State	Aux Input State		
Any	Startup Checks	Energized	Lockout	Airflow Input Stuck
		De-energized	Proven Pre-Purge	N/A
	Proven Pre Purge	Energized	No effect	N/A
		De-energized	Lockout	Failed to Prove Airflow While Purging
Forced Draft Fan	Any fuel state	Energized	No effect	N/A
		De-energized	Lockout	Failed to Prove Airflow While Running
Purge Fan	Any fuel state	Any	No effect	N/A

5.11.8 SYSTEM BEHAVIOR – AUX IN MAIN PERMISSIVE

Scenario			State Transition	Controller Alerts
Settings Configuration	Controller State	Aux Input State		
Aux In Contact Mode: Main Permissive	Any non-main state	Energized	No effect	N/A
		De-energized	No effect	Aux In Contact Open main permissive
	Any main fuel state	Energized	No effect	N/A
		De-energized	Pilot ¹	Aux In Contact Open main permissive

¹ When Pilot Off mode is set to Off After Main On, the controller transitions to the Waiting state, then purges the system before reigniting and proceeding to Pilot.

5.12 EMERGENCY SHUTDOWN INPUT

5.12.1 DETAILS

Terminals	22 & 23
Name	ESD
Type	Digital Input

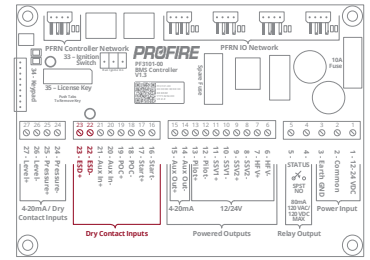

5.12.2 INTENDED FIELD DEVICE CONNECTIONS

Field Device	Configuration Requirements	Connection Diagrams
External emergency stop pushbutton	N/A	Digital Input – Dry Contact Digital Input – Wet Contact
Shutdown signal from PLC	N/A	
Plant ESD Loop	N/A	

5.12.3 SYSTEM BEHAVIOR – EMERGENCY SHUTDOWN INPUT

Scenario		State Transition	Controller Alerts
ESD Input State	Controller State		
De-energized	Any running	Lockout	ESD Contact Open alarm
	Any stopped	Alarm	ESD Contact Open alarm
Energized	Any	No effect	N/A

5.13 FUEL PRESSURE INPUT

5.13.1 DETAILS

Terminals	24 & 25
Name	Pressure
Type	Configurable digital or 4-20mA input

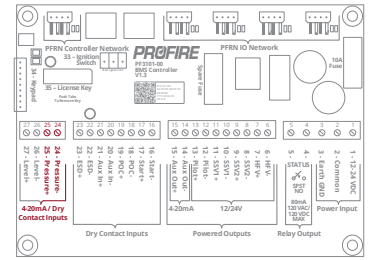

5.13.2 INTENDED FIELD DEVICE CONNECTIONS

Field Device	Configuration Requirements	Connection Diagrams
Low and high-pressure switch in series.	Controller Settings > Inputs > Fuel Pressure Input Fuel Pressure Input Mode: Dry Contact All other settings: Ignored	Combined Low/High Pressure Switch
High-pressure switch	Controller Settings > Inputs > Fuel Pressure Input Fuel Pressure Input Mode: Dry Contact High Press. All other settings: Ignored	Digital Input – Dry Contact Digital Input – Wet Contact
Low-pressure switch	Controller Settings > Inputs > Fuel Pressure Input Fuel Pressure Input Mode: Dry Contact Low Fuel Pressure Restart: Ignored * Restart Mode: Ignored * * Use the Auxiliary Input to connect a low fuel pressure switch if Low Fuel Pressure Restart functionality is required.	Digital Input – Dry Contact Digital Input – Wet Contact
4-20mA pressure transmitter	Controller Settings > Inputs > Fuel Pressure Input Fuel Pressure Input Mode: 4-20 Input All other settings: As desired Controller Settings > Inputs > Aux In Contact Main Permissive Masking: As desired UI Config Tab > Settings > UI Settings Pressure Units: As desired	Loop Powered Transmitter Self Powered Transmitter
Not used	Controller Settings > Inputs > Fuel Pressure Input Fuel Pressure Input Mode: Disabled All other settings: Ignored	N/A

5.13.3 SYSTEM BEHAVIOR – PRESSURE INPUT IN DRY CONTACT MODE

Scenario			State Transition	Controller Alerts
Configuration Details	Controller State	Pressure Input		
Any	Any	Energized	No effect	N/A
		De-energized	Lockout/Alarm	Fuel Pressure Contact Open alarm

5.13.4 SYSTEM BEHAVIOR – PRESSURE INPUT IN 4-20 MODE

Scenario			State Transition	Controller Alerts
Configuration Details	Controller State	Pressure Input		
Low Pressure Restart: Any Restart Mode: Any	Any	Out of Range	Lockout/Alarm	Pressure Input Range Error alarm
	Any non-main state	High Trip	No effect	High Fuel Pressure warning
	Any main fuel state	High Trip	Lockout	High Fuel Pressure After Main On
Low Pressure Restart: Disabled Restart Mode: Any	Any	Low Trip	Lockout/Alarm	Low Fuel Pressure
Low Pressure Restart: Enabled Restart Mode: Wait	Any stopped	Low Trip	No effect	Low Fuel Pressure Wait ¹
	Any running	Low Trip	Waiting	Low Fuel Pressure Wait ¹
Low Pressure Restart: Enabled Restart Mode: Main Permissive	Any non-main state	Low Trip	No effect	Low Fuel Pressure main permissive
	Any main fuel state	Low Trip	Pilot ²	Low Fuel Pressure main permissive

¹ When Main Permissive Masking setting is Enabled and there is a main permissive alert present on the controller, the pressure wait is hidden and the controller remains in its current state.

² When Pilot Off mode is set to Off After Main On, the controller transitions to the Waiting state, then purges the system before reigniting and proceeding to Pilot.

5.13.5 SYSTEM BEHAVIOR – PRESSURE INPUT IN DRY CONTACT HIGH PRESSURE MODE

Scenario			State Transition	Controller Alerts
Configuration Details	Controller State	Pressure Input		
Any	Any	Energized	No effect	N/A
	Any non-main state	De-energized	No effect	High Fuel Pressure warning
	Any main fuel state	De-energized	Lockout	High Fuel Pressure After Main On

5.14 LEVEL/FLOW INPUT

5.14.1 DETAILS

Terminals	26 & 27
Name	Level/Flow
Type	Configurable digital or 4-20mA input

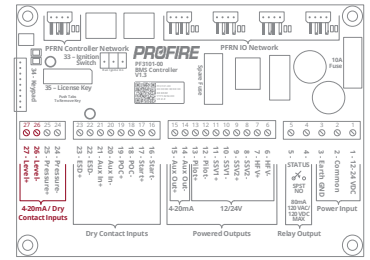

5.14.2 INTENDED FIELD DEVICE CONNECTIONS

Field Device	Configuration Requirements	Connection Diagrams
4-20mA level or flow transmitter	<p>Controller Settings > Inputs > Level/Flow Input Level/Flow Input Mode: 4-20 Input Local Level/Flow Input: Enabled All other settings: As desired</p> <p>Controller Settings > Inputs > Aux In Contact Main Permissive Masking: As desired</p> <p>System Settings > UI Settings Volume Units: As desired</p>	<p>Loop Powered Transmitter Self Powered Transmitter</p>
Digital level or flow switch	<p>Controller Settings > Inputs > Level/Flow Input Level/Flow Input Mode: Dry Contact Local Level/Flow Input: Enabled Low Level/Flow Restart*: As desired Low Level/Flow Delay*: As desired All other settings: Ignored</p> <p>Controller Settings > Inputs > Aux In Contact Main Permissive Masking: As desired</p> <p>* Low Level/Flow Restart and Low Level/Flow Delay settings apply whether connected to a low switch or a high switch.</p>	<p>Digital Input – Dry Contact Digital Input – Wet Contact</p>
Level Sharing – Appliance level/flow device wired to another controller in the appliance	<p>Controller Settings > Inputs > Level/Flow Input Level/Flow Input Mode: Same for all controllers Local Level/Flow Input: Disabled All other settings: As desired</p>	N/A – There should be nothing connected to the Level/Flow input of this controller.
Not used	<p>Controller Settings > Inputs > Level/Flow Input Level/Flow Input Mode: Disabled</p>	N/A

5.14.3 SYSTEM BEHAVIOR – LEVEL/FLOW INPUT

Scenario			State Transition	Controller Alerts
Configuration Details	Controller State	Input State		
Input Mode: Dry Contact Level/Flow Restart: Disabled	Any	Energized ¹	No effect	N/A
		De-energized ²	Lockout/Alarm	Level/Flow Contact Open alarm
Input Mode: Dry Contact Level/Flow Restart: Enabled	Any	Energized ¹	No effect	N/A
	Any stopped state	De-energized ²	No effect	Level/Flow Contact Open wait ⁵
	Any running state	De-energized ²	Waiting ⁵	Level/Flow Contact Open wait ⁵
Input Mode: 4-20 Input Level/Flow Restart: Any	Any	Out of Range ³	Lockout/Alarm	Level/Flow Range Error alarm
		High Trip ⁴	No effect	High Level/Flow warning
Input Mode: 4-20 Input Level/Flow Restart: Disabled	Any	Low Trip ⁴	Lockout/Alarm	Low Level/Flow alarm
Input Mode: 4-20 Input Level/Flow Restart: Enabled	Any stopped state	Low Trip ⁴	No effect	Low Level/Flow wait ⁵
	Any running state	Low Trip ⁴	Waiting ⁵	Low Level/Flow wait ⁵

¹ The appliance Level/Flow input is energized when the first communicating Local Level/Flow input is energized.

² The appliance Level/Flow input is de-energized when the first communicating Local Level/Flow input is de-energized.

³ The appliance Level/Flow input is out of range when all Local Level/Flow inputs are out of range.

⁴ The appliance Level/Flow input is tripped when the first communicating Local Level/Flow input is tripped.

⁵ When Main Permissive Masking setting is Enabled and there is a main permissive alert present on the controller, the level wait is hidden and the controller remains in its current state.



The following is for applications that have multiple Level/Flow devices monitoring a single Level/Flow input (i.e., Level/Flow Sharing):

Warning - Level/Flow input redundancy is supported for hardware redundancy only (i.e., the system continues to run if a Level/Flow input loses communication with the appliance or goes out of range, but the Level/Flow input state is determined by a single input only). The input state of the Level/Flow input is determined by the first Local Level/Flow input to establish communication with the appliance only.

5.15 PFRN CONTROLLER NETWORK

5.15.1 DETAILS

Terminal	28 only
Name	PFRN Controller Network
PFRN Class	Interface - Controller
Type	Power producing PFRN port
Connector type	PF3100 PFRN Connector

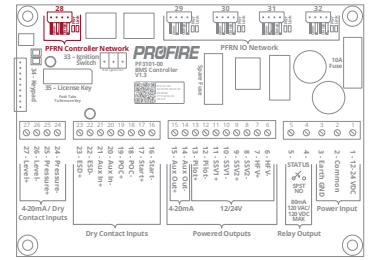

5.15.2 INTENDED FIELD DEVICE CONNECTIONS

Field Device	Configuration Requirements	Connection Diagrams
PF3100-00 UI card	Appliance Wizard Follow on-screen instructions to configure appliance	PFRN Connector Wiring UI PFRN Connection Options
PF3107-00 Modbus card		
PF3106-00 Network card		

5.15.3 SYSTEM BEHAVIOR – DIAGNOSTIC LEDES

Name	Color	LED Behavior	Interpretation	Issue/Corrective Action
Pwr ¹	Blue	Off	Port has no power	No BMS Power – Check all PFRN wire terminations and make sure BMS Controller card is powered on. Hardware fault - Contact Profire for replacement card
		On – Solid	Port has power	N/A
		On – Flickering	Port has intermittent power	Hardware fault - Contact Profire for replacement card
Link ¹	Green	Off	Port is not communicating	No PFRN Communication – Cycle power to BMS controller card and check PFRN wire terminations at BMS and UI connector.
		On – Solid	Port is communicating normally	N/A
		On – Flickering	Port is communicating normally	N/A

¹ The Pwr and Link LED labels are incorrectly swapped on v1.3.x BMS Controller cards; the LED labelled “Pwr” is actually the “Link” LED and vice versa.

5.16 PFRN I/O NETWORK

5.16.1 DETAILS

Terminals	29, 30, 31 & 32
Name	PFRN IO Network
PFRN Class	Controller - IO
Type	Power producing PFRN ports
Connector type	PF3100 PFRN Connector

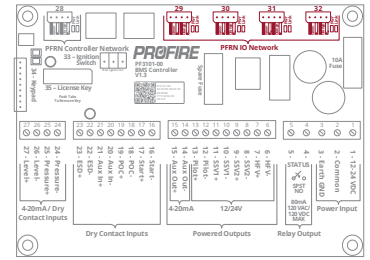

5.16.2 INTENDED FIELD DEVICE CONNECTIONS

Field Device	Configuration Requirements	Connection Diagrams
PF3102-00 Ion Pilot card	Pilot Wizard Follow on-screen instructions	PFRN Connector Wiring I/O Card PFRN Wiring Options
PF3102-01 UV Pilot card	Controller Settings > Setup > Other Comm Loss Restart: As desired	
PF3103-00 Temperature card	Temperature Wizard - Follow on-screen instructions	
PF3113-00 I/O Expansion card	I/O Wizard - Follow on-screen instructions	
Any card above via PF3106-00 Network card	As above	

5.16.3 SYSTEM BEHAVIOR – DIAGNOSTIC LEDS

Name	Color	LED Behavior	Interpretation	Issue/Corrective Action
Pwr ¹	Blue	Off	Port has no power	No BMS Power – Check all PFRN wire terminations and make sure BMS Controller card is powered on. Hardware fault - Contact Profire for replacement card
		On – Solid	Port has power	N/A
		On – Flickering	Port has intermittent power	Hardware fault - Contact Profire for replacement
Link ¹	Green	Off	Port is not communicating	No PFRN Communication – Cycle power to BMS card and check PFRN wiring at BMS and connected I/O.
		On – Solid	Port is communicating normally	N/A
		On – Flickering		

¹ The Pwr and Link LED labels are incorrectly swapped on v1.3.x BMS Controller cards; the LED labelled “Pwr” is actually the “Link” LED and vice versa.

5.16.4 SYSTEM BEHAVIOR – LOST COMMUNICATIONS

Scenario			State Transition	Controller Alerts
BMS lost communications with:	Comm Loss Restart Setting	Controller State		
PF3102-00 Ion Pilot card(s) or PF3102-01 UV Pilot card(s) When Minimum Pilots Running setting is satisfied	Any	Any	No effect	Pilot Module Comm warning
PF3102-00 Ion Pilot card(s) or PF3102-01 UV Pilot card(s) When Minimum Pilots Running setting is not satisfied	Disabled	Any	Lockout/Alarm	Pilot Module Comm Error alarm
	Enabled	Any stopped	No effect	Pilot Module Comm warning Loss of Communications wait * * The wait turns into an alarm after 5 minutes
		Any running	Waiting	
PF3103-00 Temperature card See note 2 for behavior with redundant inputs	Any	Any	Lockout/Alarm	No Valid Primary Process Temp alarm Thermocouple Failure warning
PF3113-00 IO Expansion card with Main Permissive input See note 2 for behavior with redundant inputs	Any	Any non-main	No effect	IO Expansion Input Invalid main permissive
	Any	Any main state	Pilot ¹	
PF3113-00 with Wait input See note 2 for behavior with redundant inputs	Any	Any stopped	No effect	IO Expansion Input Invalid wait
	Any	Any running	Waiting	
PF3113-00 with Alarm input See note 2 for behavior with redundant inputs	Any	Any	Lockout/Alarm	IO Expansion Input Invalid alarm
PF3113-00 with Warning input See note 2 for behavior with redundant inputs	Any	Any	No effect	IO Expansion Input Invalid warning
PF3113-00 with Display input	Any	Any	No effect	N/A

¹ When Pilot Off mode is set to Off After Main On, the controller transitions to the Waiting state, then purges the system before reigniting and proceeding to Pilot.

² The system acts on a communication loss event only when all redundant inputs lose communication with the BMS controller (e.g., A running system with three thermocouple devices measuring a single temperature input continues to run if one or two of the thermocouple inputs lose communication with the BMS controller).

5.17 EXTERNAL IGNITION SWITCH INPUT

5.17.1 DETAILS

Terminals	33 (Run, Ignite, On)
Name	Ignition Switch
Type	Digital Input

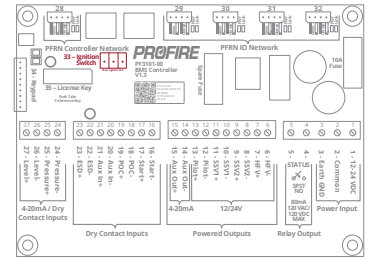

5.17.2 INTENDED FIELD DEVICE CONNECTIONS

Field Device	Configuration Requirements	Connection Diagrams
Profire PF3100 Ignition Switch	Controller Settings > Setup > Other BMS User Interface: Enabled	N/A – Connect Profire-supplied Ignition Switch only to BMS Controller card Ignition Switch terminals.
Not used	Controller Settings > Setup > Other BMS User Interface: Disabled	N/A

5.17.3 SYSTEM BEHAVIOR – EXTERNAL IGNITION SWITCH

Scenario			State Transition	Controller Alerts
BMS User Interface Setting	Switch state	Controller State		
Disabled	Any	Any	No effect	N/A
Enabled	Stop	Any	Lockout/Alarm	Stopped via External Switch alarm
	Run	Any	No effect	N/A
	Ignite for less than 1s	Any	No effect	N/A
	Ignite for more than 1s and less than 10s	Ready	Startup	N/A
		Any state other than Ready	No effect	N/A
	Ignite for more than 10s	Any	Lockout/Alarm	External Switch Stuck alarm
Run to Stop to Run	Lockout	Ready/Alarm	Any alert conditions that persist after the lockout is acknowledged are displayed.	

5.18 BMS FRONT PANEL LED OUTPUT

5.18.1 DETAILS

Terminals	34
Name	Keypad
Alternate Name	LED Board
Type	Digital Output

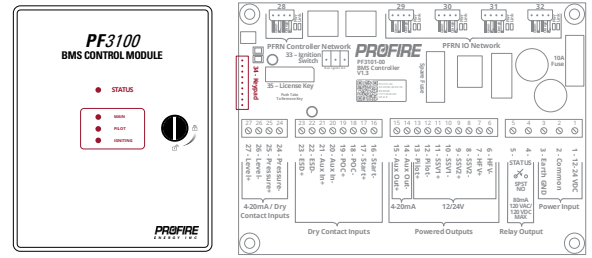

5.18.2 INTENDED FIELD DEVICE CONNECTIONS

Field Device	Configuration Requirements	Connection Diagrams
Profire LED display board	Controller Settings > Setup > Other BMS User Interface: Enabled	N/A – Connect only Profire-supplied LED board to BMS Controller card keypad terminal.
Not used	Controller Settings > Setup > Other BMS User Interface: Disabled	N/A

5.18.3 SYSTEM BEHAVIOR – BMS ENCLOSURE LEDS

Scenario			Indication
LED Name	LED Color	LED Behavior	
Status	Red	Solid	Controller stopped – in Ready state
		Slow flashing	Controller stopped – alarm present
		Fast flashing	Controller stopped – in Lockout state
	Amber	Solid	Controller running – warnings present
		Slow flashing	Controller running – waits and warnings present
	Green	Solid	Controller running – no waits or warnings present
Slow flashing		Controller running – waits present	
Main	Blue	On	SSV valve outputs energized
		Off	SSV valve outputs de-energized
Pilot	Blue	On	Pilot valve output energized
		Off	Pilot valve output de-energized
Igniting	Blue	On	Ignition coil output(s) energized
		Off	Ignition coil output(s) de-energized

6 PF3102-00 ION PILOT CARD

The Ion Pilot card is an I/O card designed to connect to a BMS controller card to facilitate the following:

1. Pilot flame ignition for a single pilot flame.
2. Ionization flame detection or thermocouple flame detection for a single pilot flame.
3. Ionization flame detection for a main flame.

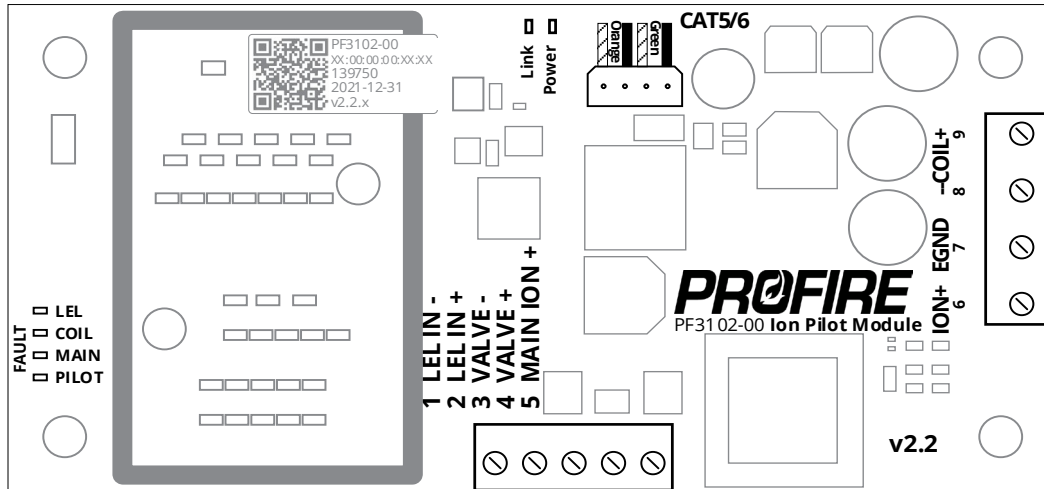

6.1 TERMINAL RATINGS

Name	Safety Rated	Terminal	Input/Output	Electrical Ratings
PFRN I/O Network	Yes	- CAT5/6	I/O	36 V _{DC} , 1A maximum
Ion Aux Input	Yes	1 LEL IN -	I	18V _{DC} max, 25mA maximum
		2 LEL IN +	O	12V _{DC} , 50mA maximum
Pilot Output	Yes	3 VALVE -	O	0-12V _{DC} 2A maximum Pulsed Output with configurable PWM Expected Load: Inductive/Resistive
		4 VALVE +		
Main Flame Detection	Yes	5 MAIN ION +	I/O	65 V _{rms} output 20kΩ source impedance
Pilot Flame Detection	Yes	6 ION -	I/O	65 V _{rms} output 20kΩ source impedance
		7 ION +		
Earth Ground		8 EGND		
Coil Output	Yes	9 COIL -	O	14V _{DC} pulsed output 2A Peak, ~100mA _{rms} while sparking
		10 COIL +		

6.2 ION AUXILIARY INPUT

6.2.1 DETAILS

Terminals	1 & 2
Name	Ion Aux In
Alternate Name	LEL
Type	4-20mA analog input

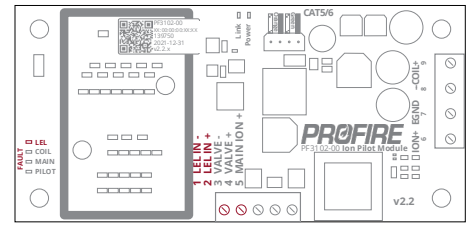

6.2.2 INTENDED FIELD DEVICE CONNECTIONS

Field Device	Configuration Requirements	Connection Diagrams
Digital input switch	Pilot Wizard > Allocate Pilot Tab Ion Aux In Type: Dry Contact Enabled/Disabled: Enabled Controller Settings > Inputs > Ion Aux In Ion Aux Input Mode: High Trip Alarm All other settings: Ignored	Digital Input - Dry Contact Digital Input - Wet Contact
4-20mA transmitter for high trip shutdown	Pilot Wizard > Allocate Pilot Tab Ion Aux In Type: 4-20 Input Enabled/Disabled: Enabled Controller Settings > Inputs > Ion Aux In Ion Aux Input Mode: High Trip Alarm All other settings: As Desired	Loop Powered Transmitter Self Powered Transmitter
4-20mA temperature transmitter for flame detection <small>* All connected Ion Pilot Modules must be configured for TC flame detection (i.e., Ionization detection and thermocouple detection cannot be used at the same time for a single appliance).</small>	Pilot Wizard > Allocate Pilot Tab Ion Aux In Type: 4-20 Input Enabled/Disabled: Enabled Controller Settings > Inputs > Ion Aux In Ion Aux Input Mode: TC Flame Detect All other settings: As Desired	TC Flame Detection
Not used	Pilot Wizard Ion Aux In Type: Disabled	N/A

6.2.3 SYSTEM BEHAVIOR - ION AUX INPUT

Scenario			Pilot Flame	LEL Fault LED	State Transition	Controller Alerts
Ion Aux input Mode	Ion Aux Input Signal	Controller State				
High Trip Alarm - Digital	Energized	Any	N/A	Off	No effect	N/A
	De-energized	Any	N/A	Off	Lockout/Alarm	Ion Aux In Tripped alarm
High Trip Alarm - 4-20	Out of Range	Any	N/A	On	Lockout/Alarm	Ion Aux In Contact Range Error alarm
	At or above Trip Point	Any	N/A	Off	Lockout/Alarm	Ion Aux In Tripped alarm
	Below Trip Point ¹	Any	N/A	Off	No effect	N/A ¹
TC Flame Detect	Out of Range	Any	N/A	On	Lockout/Alarm	Ion Aux In Contact Range Error alarm
	At or above Trip Point	Any	Detected	Off	Refer to Operating Sequence section for behavior	
	Below Trip Point	Any	Not detected	Off		

¹ When returning from a high trip event, the controller does not consider the trip event to be cleared until the signal drops below the configured Ion Aux In Trip Point minus the configured Ion Aux In Deadband.

6.3 ION PILOT VALVE OUTPUT

6.3.1 DETAILS

Terminals	3 & 4
Name	Valve
Type	12V Powered solenoid output with configurable PWM

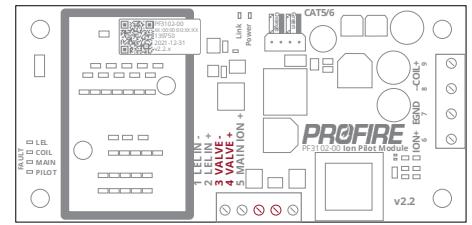

6.3.2 INTENDED FIELD DEVICE CONNECTIONS

Field Device	Configuration Requirements	Connection Diagrams
12V normally closed gas shutoff valve – Peak and hold	Pilot Wizard > Allocate Pilot Tab Enabled/Disabled: Enabled Pilot Wizard > Ignition Settings Tab Minimum Pilots Running: As required per appliance safety specifications Pilot Relight Mode: As desired Controller Settings > Outputs > Valves Pilot Valve PWM: As desired Controller Settings > Process Control > Process Temp Control Pilot Off Mode: As desired Controller Settings > Inputs > Flame Detection Main Flame Detect: As desired per Pilot off Mode	Solenoid Output
12V normally closed gas shutoff valve – Constant current	Same as above except: Controller Settings > Outputs > Valves Pilot Valve PWM: 100%	Solenoid Output
24V normally closed gas shutoff valve	Not Supported - Connect to the BMS card Pilot Solenoid Output rather than the Ion Pilot card Valve output.	

6.3.3 ION PILOT VALVE OUTPUT BEHAVIOR BY CONTROLLER STATE

Pilot Off Mode Setting	Power On	Lockout	Alarm	Ready	Waiting	Startup Checks	Proven Pre-Purge	Ignition	Pilot	Low Fire	Process Control
Disabled Off at Setpoint Follow Main	D	D	D	D	D	D	D	E	E	E	E
Off after Main On	D	D	D	D	D	D	D	E	E	D ^{2,3}	D ^{2,3}

¹ E = Energized, D = De-energized

² Main Flame Detect setting must be enabled

³ Energized under reignition conditions in accordance with configured Pilot Relight Mode and Pilot Relight Timeout settings (Controller Settings > Outputs > Ignition).

6.4 MAIN IONIZATION FLAME DETECTION INPUT

6.4.1 DETAILS

Terminals	5 & 7
Name	Main Ion
Type	Ionization flame detection input using flame rectification

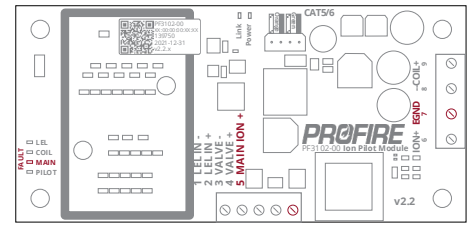

6.4.2 INTENDED FIELD DEVICE CONNECTIONS

Field Device	Configuration Requirements	Connection Diagrams
Flame rod installed in main flame only	Pilot Wizard > Allocate Pilot Tab Flame Detection Gain: As desired Enabled/Disabled: Enabled Controller Settings > Inputs > Flame Detection Main Flame Detect: Enabled	See main flame detection rod wiring in any of the following diagrams: Single Rod Ignition Wiring Dual Rod Ignition Wiring Ion Pilot High Energy Ignition Wiring
Not used	Controller Settings > Inputs > Flame Detection Main Flame Detect: Disabled	N/A

6.4.3 SYSTEM BEHAVIOR – MAIN FLAME DETECTION

Pilot Flame Diagnostic Readings ¹		Controller Interpretation	Main Fault LED	State Transition	Controller Alerts
Flame Strength	Above 600mV	Strong main flame detected	Off	Refer to Operating Sequence section for behavior	
	Between 500mV and 600mV	Weak main flame detected	Off		
	Below 500mV	No main flame detected	Off		
AC (V _{PP})	Above 300mV with passed load monitor check	Acceptable flame load	Off	No effect	N/A
	Below 300mV	Unacceptable flame load	On	Lockout/Alarm	Main Load Monitor Error alarm
DC High	700mV to 3000mV ²	Acceptable flame voltage	Off	No effect	N/A
	Above 3000mV ² or Below 700mV	Unacceptable flame voltage	On	Lockout/Alarm	Main Flame Detect Voltage Error alarm
DC Low	Any	For reference only	Off	No effect	N/A

¹ Flame Diagnostic readings are displayed on the [Flame Diagnostics screen](#).

² This value may exceed 3000mV under flame sharing conditions.

6.5 PILOT IONIZATION FLAME DETECTION INPUT

6.5.1 DETAILS

Terminals	6 & 7
Name	ION+
Type	Ionization flame detection input utilizing flame rectification.

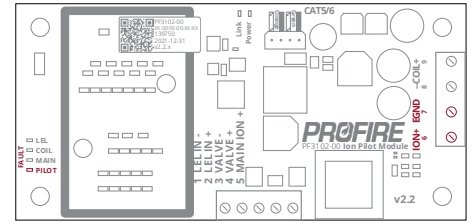

6.5.2 INTENDED FIELD DEVICE CONNECTIONS

Field Device	Configuration Requirements	Connection Diagrams
Flame rod installed in pilot flame	<p>Pilot Wizard > Allocate Pilot Tab Flame Detection Gain: As desired Ion Aux In Type: As desired Enabled/Disabled: Enabled</p> <p>Pilot Wizard > Ignition Settings Tab Minimum Pilots Running: As required per appliance safety specifications</p> <p>Controller Settings > Inputs > Ion Aux Input Ion Aux In Mode (If enabled above): Cannot be set to TC Flame Detect</p>	<p>Single Rod Ignition Wiring</p> <p>Dual Rod Ignition Wiring</p> <p>Ion Pilot High Energy Ignition Wiring</p>

6.5.3 SYSTEM BEHAVIOR – PILOT FLAME DETECTION

Pilot Flame Diagnostic Readings		Controller Interpretation	Pilot Fault LED	State Transition	Controller Alerts
Flame Strength	Above 600mV	Strong pilot flame detected ¹	Off	Refer to Operating Sequence section for behavior	
	Between 500mV and 600mV	Weak pilot flame detected ¹	Off		
	Below 500mV	No pilot flame detected ¹	Off		
AC (V _{PP})	Above 300mV with passed load check	Acceptable flame load	Off	No effect	N/A
	Below 300mV	Unacceptable flame load	On	Lockout/Alarm	Pilot Load Monitor Error alarm
DC High	700mV to 3000mV ²	Acceptable flame voltage	Off	No effect	N/A
	Above 3000mV ² or Below 700mV	Unacceptable flame voltage	On	Lockout/Alarm	Pilot Flame Detect Voltage Error alarm
DC Low	Any	For reference only	Off	No effect	N/A

¹ Pilot flame detection is determined based on the flame strength of all configured pilots in accordance with the configured Minimum Pilots Running setting (Pilot Wizard > Ignition Settings Tab).

² This value may exceed 3000mV under flame sharing conditions.

6.6 PILOT IGNITION COIL OUTPUT

6.6.1 DETAILS

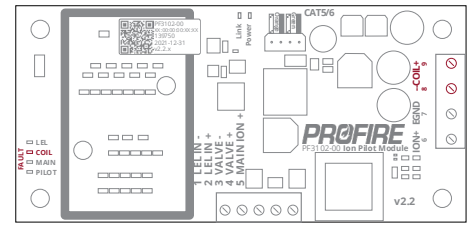

Terminals	8 & 9
Name	Coil
Type	Powered ignition output

6.6.2 INTENDED FIELD DEVICE CONNECTIONS

Field Device	Configuration Requirements	Connection Diagrams
Ignition coil	Controller Settings > Outputs > Ignition Ignition Mode: Coil All other settings: As desired	Single Rod Ignition Wiring Dual Rod Ignition Wiring
Separate ignition module with 12V DC input	Controller Settings > Outputs > Ignition Ignition Mode: HEI All other settings: As desired	Ion Pilot High Energy Ignition Wiring

6.6.3 ION PILOT COIL OUTPUT BEHAVIOR BY CONTROLLER STATE

Ignition Mode	Power On	Lockout	Alarm	Ready	Waiting	Startup Checks	Proven Pre-Purge	Ignition	Pilot	Low Fire	Process Control
Coil	D	D	D	D	D	D	D	E ³	D ^{2,3}	D ^{2,3}	D ^{2,3}
HEI	D	D	D	D	D	D	D	E ⁴	D ^{2,4}	D ^{2,4}	D ^{2,4}

¹ E = Energized, D = De-energized

² Energized under reignition conditions in accordance with configured Pilot Relight Mode and Pilot Relight Timeout settings (Controller Settings > Outputs > Ignition).

³ Coil output is energized with a pulsed output when Ignition Mode is set to Coil.

⁴ Coil output is energized with a steady 12V output when Ignition Mode is set to HEI.

6.7 PFRN PORT

6.7.1 DETAILS

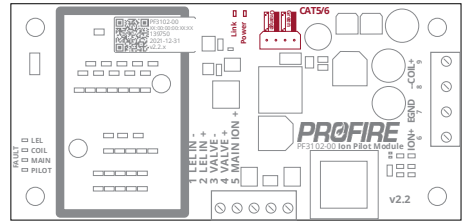

Terminals	10
Name	PFRN
Type	PFRN I/O Network Port

6.7.2 INTENDED FIELD DEVICE CONNECTIONS

Field Device	Configuration Requirements	Connection Diagrams
PF3101-00 BMS card PFRN I/O Network port	<p>Pilot Wizard > Allocate Pilot Tab Enabled/Disabled: Enabled</p> <p>Controller Settings > Setup > Other Comm Loss Restart: As desired</p>	<p>PFRN Connector Wiring</p> <p>I/O Card PFRN Wiring Options</p>
PF3101-00 BMS card PFRN I/O Network port via PF3106-00 Network Switch card	<p>Pilot Wizard > Allocate Pilot Tab Enabled/Disabled: Enabled</p> <p>Controller Settings > Setup > Other Comm Loss Restart: As desired</p>	

6.7.3 SYSTEM BEHAVIOR – PFRN DIAGNOSTIC LEDS

Name	Color	LED Behavior	Interpretation	Issue/Corrective Action
Pwr	Blue	Off	Port has no power	No BMS Power - Make sure BMS Controller card is powered on. Wiring fault - Check PFRN wire terminations at BMS and Pilot card. Hardware fault - Contact Profire for replacement.
		On – Solid	Port has power	N/A
		On – Flickering	Port has intermittent power	Wiring fault - Check PFRN wire terminations at BMS and Pilot card. Hardware fault - Contact Profire for replacement.
Link	Green	Off/flickering	Port is not communicating	No PFRN Communication – Cycle power to BMS card and check PFRN wire terminations at BMS and Pilot card.
		On – Solid	Port is communicating normally	N/A

6.7.4 SYSTEM BEHAVIOR UPON COMMUNICATION LOSS

Refer to [BMS PFRN I/O Network System Behavior](#) for behavior under communication loss conditions.

7 PF3102-01 UV PILOT CARD

The UV Pilot card is an I/O card designed to connect to a BMS controller card to facilitate the following:

1. Pilot flame ignition
2. Pilot UV flame detection.
3. Main UV flame detection.

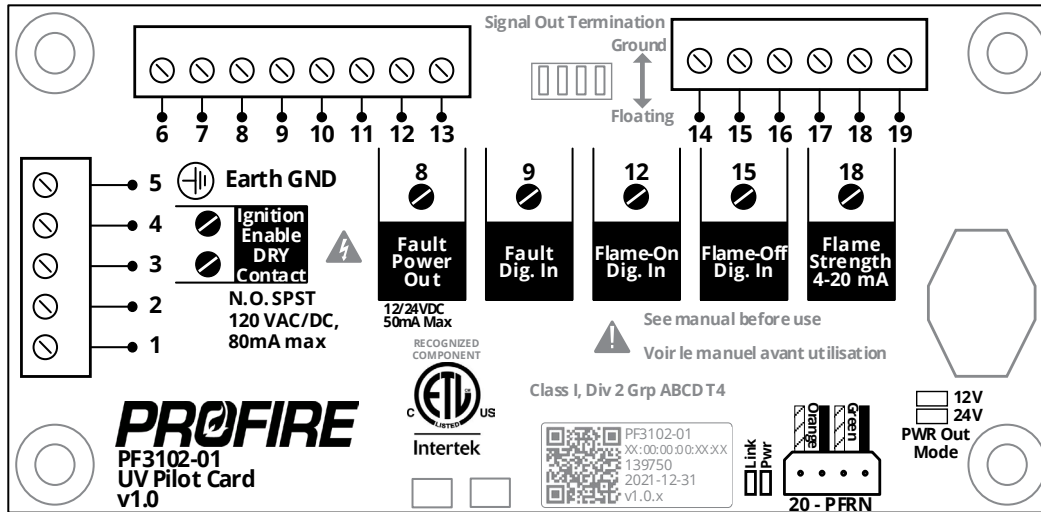

7.1 TERMINAL RATINGS

Name	Safety Rated	Terminal	Input/ Output	Electrical Ratings
Not used	-	1 2	Not used	
Ignition Enable	Yes	3 A 4 B	O	Normally open dry contact 120 V _{AC} /V _{DC} maximum 80mA maximum
Earth Ground	-	5 EGND	-	
Not used	-	6 7	Not used	
UV Fault	Yes	8 Power Out 9 Dig. In	O I	12/24V _{DC} , 25mA maximum 30 V _{DC} max, 0.7mA minimum wetting current
Not used	-	10 11	Not used	
Flame-On	Yes	12 Dig. In	I	30 VDC max, 0.7mA minimum wetting current
Not used	-	13 14	Not used	
Flame-Off	Yes	15 Dig. In	I	30 VDC max, 0.7mA minimum wetting current
Not used	-	16 17	Not used	
Flame Strength	No	18 4-20mA	I	30 V _{DC} , 25mA maximum
Not used	-	19	Not used	
PFRN I/O Network	Yes	20 PFRN	I/O	36 V _{DC} , 1A maximum

7.2 IGNITION ENABLE RELAY CONTACT

7.2.1 DETAILS

Terminals	3 & 4
Name	Ignition Enable Dry Contact
Type	Normally open dry contact

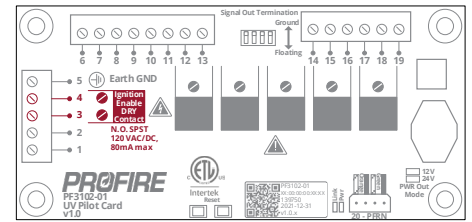

7.2.2 INTENDED FIELD DEVICE CONNECTIONS

Field Device	Configuration Requirements	Connection Diagrams
High Energy Ignition module via relay	Pilot Wizard > Allocate Pilot Tab Enabled/Disabled: Enabled	UV Pilot High Energy Ignition Wiring
PF3102-03 Pilot Spark card	Pilot Wizard > Allocate Pilot Tab Enabled/Disabled: Enabled	UV Pilot to Spark Card Wiring

7.2.3 UV PILOT IGNITION ENABLE RELAY BEHAVIOR BY CONTROLLER STATE

System Configuration	Power On	Lockout	Alarm	Ready	Waiting	Startup Checks	Proven Pre-Purge	Ignition	Pilot	Low Fire	Process Control
Any	D	D	D	D	D	D	D	E	D ²	D ²	D ²

¹ E = Energized, D = De-energized

² Energized under reignition conditions in accordance with configured Pilot Relight Mode and Pilot Relight Timeout settings (Controller Settings > Outputs > Ignition).

7.3 REQUIRED UV FLAME SCANNER INPUTS

7.3.1 DETAILS

Terminals	8 & 9, 12, 15
Name	Fault, Flame On, Flame Off
Type	Digital Inputs

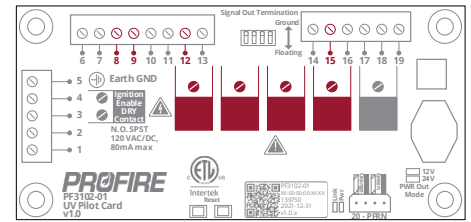

7.3.2 INTENDED FIELD DEVICE CONNECTIONS

Field Device	Configuration Requirements	Connection Diagrams
UV flame scanner - Fireye 65UV5 or equivalent	Pilot Wizard – Follow on-screen instructions to configure card	UV Flame Scanner Wiring

7.3.3 SYSTEM BEHAVIOR – UV FLAME DETECTION

Fault Input	Scenario		Controller Interpretation	State Transition	Controller Alerts	
	Flame On Input	Flame Off Input				
Energized	Any	Any	No fault	No effect	N/A	
De-energized	Any	Any	Fault	Lockout/Alarm	UV Flame Detect Fault alarm	
Any	Energized	Energized	Fault	Lockout/Alarm	UV Flame Detect Mismatch alarm	
	De-energized	De-energized	Fault	Lockout/Alarm	UV Flame Detect Mismatch alarm	
	Energized	De-energized	Flame detected	Refer to Operating Sequence section for behavior		
	De-energized	Energized	Flame not detected			

7.4 UV FLAME SCANNER FLAME STRENGTH INPUT

7.4.1 DETAILS

Terminals	18
Name	Flame Strength
Type	Display only 4-20mA analog input

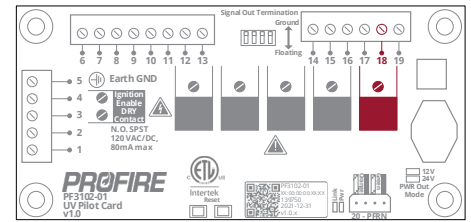

7.4.2 INTENDED FIELD DEVICE CONNECTIONS

Field Device	Configuration Requirements	Connection Diagrams
UV flame scanner 4-20mA flame strength output	Pilot Wizard > Allocate Pilot Tab Enabled/Disabled: Enabled	UV Flame Scanner Wiring
Not Used	N/A	N/A

7.4.3 SYSTEM BEHAVIOR – UV FLAME STRENGTH

System Configuration	Flame Strength Input	Controller State	State Transition	Controller Alerts
Any	Any	Any	No effect	N/A

* UV Flame strength reading does not affect system behavior and is displayed on the [Flame Diagnostics screen](#).

7.5 PFRN PORT

7.5.1 DETAILS

Terminals	20
Name	PFRN
Type	PFRN I/O Network Port

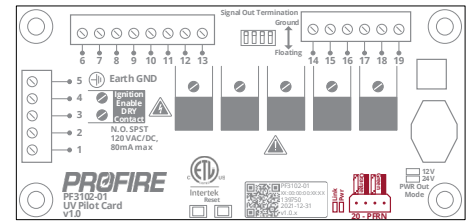

7.5.2 INTENDED FIELD DEVICE CONNECTIONS

Field Device	Configuration Requirements	Connection Diagrams
PF3101-00 BMS card PFRN I/O Network port	Pilot Wizard > Allocate Pilot Tab Enabled/Disabled: Enabled	PFRN Connector Wiring I/O Card PFRN Wiring Options
PF3101-00 BMS card PFRN I/O Network port via PF3106-00 Network Switch card		

7.5.3 SYSTEM BEHAVIOR – PFRN DIAGNOSTIC LEDS

Name	Color	LED Behavior	Interpretation	Issue/Corrective Action
Pwr	Blue	Off	Port has no power	No BMS Power - Make sure BMS Controller card is powered on. Wiring fault - Check PFRN wire terminations at BMS and Pilot card. Hardware fault - Contact Profire for replacement.
		On – Solid	Port has power	N/A
		On – Flickering	Port has intermittent power	Wiring fault - Check PFRN wire terminations at BMS and Pilot card. Hardware fault - Contact Profire for replacement.
Link	Green	Off/flickering	Port is not communicating	No PFRN Communication – Cycle power to BMS Controller card and check PFRN wire terminations at BMS and Pilot card.
		On – Solid	Port is communicating normally	N/A

7.5.4 SYSTEM BEHAVIOR UPON COMMUNICATION LOSS

Refer to [BMS PFRN I/O Network System Behavior](#) for behavior under communication loss conditions.

7.6 DIP SWITCHES

7.6.1 DETAILS

Terminals	DIP Switch 1,2,3,4
Name	Signal Out Termination
Type	DIP Switch

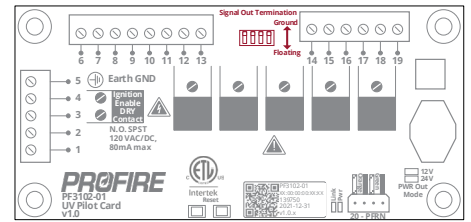

7.6.2 INTENDED APPLICATIONS

Application	Configuration Requirements	Connection Diagrams
N/A	All switches must be in the “Ground” position	N/A

7.7 POWER SETTING LEDS

7.7.1 DETAILS

Terminals	N/A
Name	Power Out Mode (12V/24V)
Type	LED

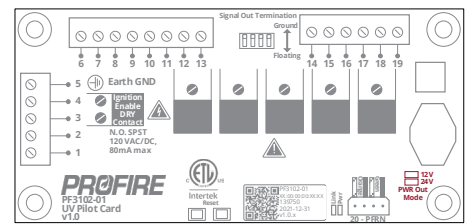

7.7.2 INTENDED APPLICATIONS

Application	Configuration Requirements	Connection Diagrams
N/A	Not applicable for PF3102-01 UV Pilot Cards	N/A

8 PF3102-03 PILOT SPARK CARD

The Pilot Spark Card is a high energy ignition module that is designed to be used in conjunction with an ignition coil to produce an intense spark for the purpose of igniting a pilot flame in applications where pilot ignition is problematic.

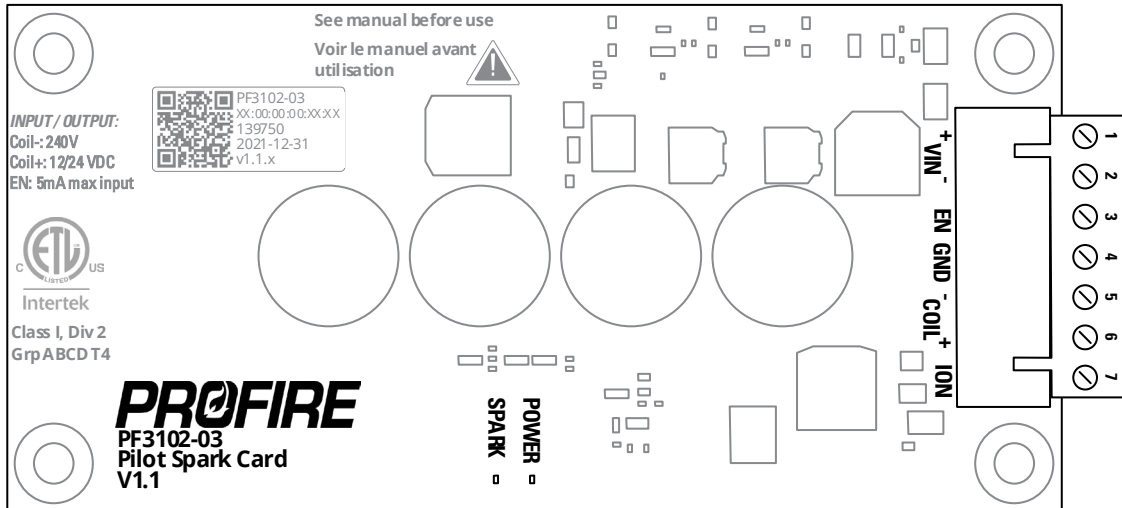

8.1 TERMINAL RATINGS

Name	Safety Rated	Terminal	Input/ Output	Electrical Ratings
Power In	No	1 VIN +	I	12/24V _{DC} , 2A maximum
		2 VIN -		
Card Enable	Yes	3 EN	I	12/24V _{DC} , 5mA maximum
Ground	-	4 GND	-	
Coil Output	Yes	5 COIL -	O	12V _{DC} , 2A maximum
		6 COIL +		
Coil Return	No	7 ION	I	Ground return path

8.2 POWER INPUT

8.2.1 DETAILS

Terminals	1 & 2
Name	VIN
Type	Power input

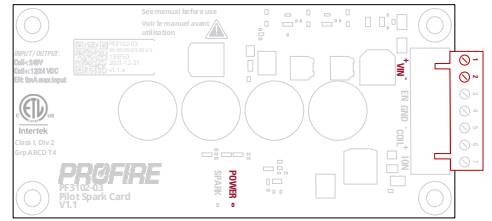

8.2.2 INTENDED FIELD DEVICE CONNECTIONS

Field Device	Configuration Requirements	Connection Diagrams
12V Power Supply	N/A	Power Input Wiring
24V Power Supply	N/A	

8.3 COIL ENABLE INPUT

8.3.1 DETAILS

Terminals	3 & 4
Name	EN
Type	Digital input

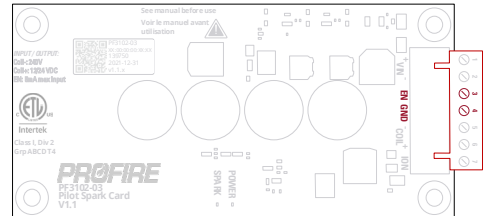

8.3.2 INTENDED FIELD DEVICE CONNECTIONS

Field Device	Configuration Requirements	Connection Diagrams
UV Pilot card Ignition enable contact	Pilot Wizard – Follow on-screen instructions to enable UV pilot card	UV Pilot to Spark Card Wiring

8.4 COIL IGNITION OUTPUT

8.4.1 DETAILS

Terminals	5, 6 & 7
Name	COIL
Type	Powered ignition output

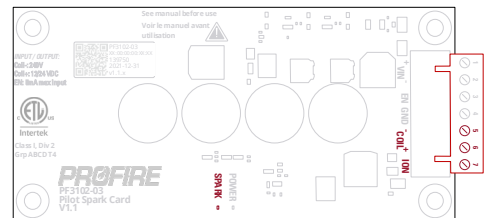

8.4.2 INTENDED FIELD DEVICE CONNECTIONS

Field Device	Configuration Requirements	Connection Diagrams
Ignition coil	N/A	UV Pilot to Spark Card Wiring

9 PF3103-00 TEMPERATURE CARD

The TC Temp card is an I/O card designed to connect to a BMS controller card to facilitate the monitoring of up to four thermocouple temperature inputs.

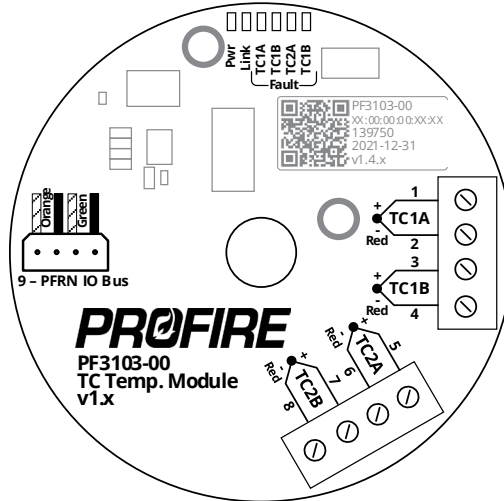

9.1 TERMINAL RATINGS

Name	Safety Rated	Terminal	Input/ Output	Electrical Ratings
TC1	Yes *	1 TC1A +	I	Differential: -6mV to 55mV
		2 TC1A - Red		
		3 TC1B +	I	
		4 TC1B - Red		
TC2	Yes *	5 TC2A +	I	
		6 TC2A - Red		
		7 TC2B +	I	
		8 TC2B - Red		
PFRN I/O Network	Yes	9 PFRN	I/O	36 V _{DC} , 1A maximum

*Input is safety rated only when configured for use with a dual element thermocouple. Inputs configured for single element thermocouples are not safety rated.

9.2 THERMOCOUPLE INPUTS

9.2.1 DETAILS

Terminals	1 & 2 and 3 & 4 and 5 & 6 and 7 & 8
Name	TC1A and TC1B and TC2A and TC2B
Type	Type K Thermocouple inputs

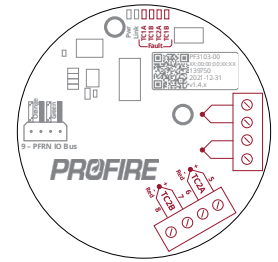

9.2.2 INTENDED FIELD DEVICE CONNECTIONS

Field Device	Configuration Requirements	Connection Diagrams
Ungrounded Type K thermocouple	<p>Temperature Wizard > Create Inputs Tab Input Type: As desired ¹ All other settings: As desired</p> <p>Temperature Wizard > Temp Modules Tab Dual Mode: Assign input to either (1) TC1A and TC1B or (2) TC2A and TC2B Single Mode: Assign input to either (1) TC1A, (2) TC1B, (3) TC2A or (4) TC2B</p> <p>Temperature Wizard > Setpoints Tab All settings: As desired</p> <p>System Settings > UI Settings Temperature Units: As desired</p>	<p>Dual-Element Thermocouple Wiring Single-Element Thermocouple Wiring</p>
Grounded or non-Type K thermocouple	N/A – Not supported	N/A – Not supported

¹ Bath Input mode is required to be set to Dual if the Bath Input is specified as a safety function.

9.2.3 SYSTEM BEHAVIOR – NON-REDUNDANT TEMPERATURE INPUTS

Scenario		State Transition	Controller Alerts
Temperature Input state	Mode		
Open/Out of Range	Disabled	No effect	Thermocouple Failure Warning
	Process Control	Lockout/Alarm	No Valid Primary Process Temperature
	Aux Process or High Temp ESD	Lockout/Alarm	No Valid Auxiliary Temperature alarm
	Display Only	No effect	Thermocouple Failure warning
Above High Temp Setpoint	Disabled or Display Only	No effect	N/A
	Process Control	Lockout/Alarm	Primary Process Temperature High ESD
	Aux Process or High Temp ESD	Lockout/Alarm	Auxiliary Temperature High ESD alarm
Below High Temp Setpoint	Disabled or Display Only or High Temp ESD	No effect	N/A
	High Temp ESD	No effect	N/A ¹
	Process Control or Aux Process	Normal Operation – Refer to Operating Sequence section for details	
Below Low Temp Setpoint	Process Control	No effect	Low Process Temp warning

¹ High Auxiliary Temperature Warning displayed If temperature is above its configured High Temp Warning Setpoint.

9.2.4 SYSTEM BEHAVIOR – REDUNDANT TEMPERATURE INPUTS

A temperature input is redundant if it is measured by multiple thermocouple devices (i.e., one created temperature input (Temperature Wizard > Create Inputs Tab) is assigned to more than one temperature card input slot (Temperature Wizard > Temp Modules Tab) either on the same card or on another card).

Scenario		State Transition	Controller Alerts
Input Reading	Mode		
Open or Out of Range (note 1)	Disabled or Display Only	No effect	Thermocouple Failure Warning
	Process Control	Lockout/Alarm	No Valid Primary Process Temperature
	Aux Process or High Temp ESD	Lockout/Alarm	No Valid Auxiliary Temperature alarm
Above High Temp Setpoint (note 1)	Disabled or Display Only	No effect	N/A
	Process Control	Lockout/Alarm	Primary Process Temperature High ESD
	Aux Process or High Temp ESD	Lockout/Alarm	Auxiliary Temperature High ESD alarm
Below High Temp Setpoint (note 1)	Disabled or Display Only	No effect	N/A
	High Temp ESD	No effect	N/A ²
	Process Control or Aux Process	Normal Operation – Refer to Operating Sequence section for details	
Below Low Temp Setpoint (note 1)	Process Control	No effect	Low Process Temp warning

¹ The input reading for redundant inputs is determined by the first communicating input that has a valid temperature reading (i.e., not open or out of range) only.

² High Auxiliary Temperature Warning displayed If temperature is above its configured High Temp Warning Setpoint.

9.3 PFRN PORT

9.3.1 DETAILS

Terminals	9
Name	PFRN IO Bus
Type	PFRN I/O Network Port

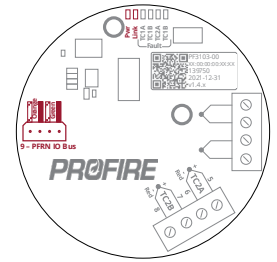

9.3.2 INTENDED FIELD DEVICE CONNECTIONS

Field Device	Configuration Requirements	Connection Diagrams
PF3101-00 BMS card PFRN I/O Network port	N/A	PFRN Connector Wiring I/O Card PFRN Wiring Options
PF3101-00 BMS card PFRN I/O Network port via PF3106-00 Network Switch card		

9.3.3 SYSTEM BEHAVIOR - DIAGNOSTIC LEDS

Name	Color	LED Behavior	Interpretation	Issue/Corrective Action
Pwr	Blue	Off	Port has no power	No BMS Power - Make sure BMS Controller card is powered on. Wiring fault - Check PFRN wire terminations at BMS and Temperature card. Hardware fault - Contact Profire for replacement.
		On - Solid	Port has power	N/A
		On - Flickering	Port has intermittent power	Wiring fault - Check PFRN wire terminations at BMS and Temperature card. Hardware fault - Contact Profire for replacement.
Link	Green	Off/flickering	Port is not communicating	No PFRN Communication - Cycle power to BMS Controller card and check PFRN wire terminations at BMS and Temperature card.
		On - Solid	Port is communicating normally	N/A

9.3.4 SYSTEM BEHAVIOR UPON COMMUNICATION LOSS

Refer to [BMS PFRN I/O Network System Behavior](#) for behavior under communication loss conditions.

10 PF3106-00 NETWORK CARD

The Network Switch card is a PFRN bus expansion card designed to facilitate system scalability by allowing additional controller or I/O cards to be added to satisfy the requirements of a variety of heating applications.

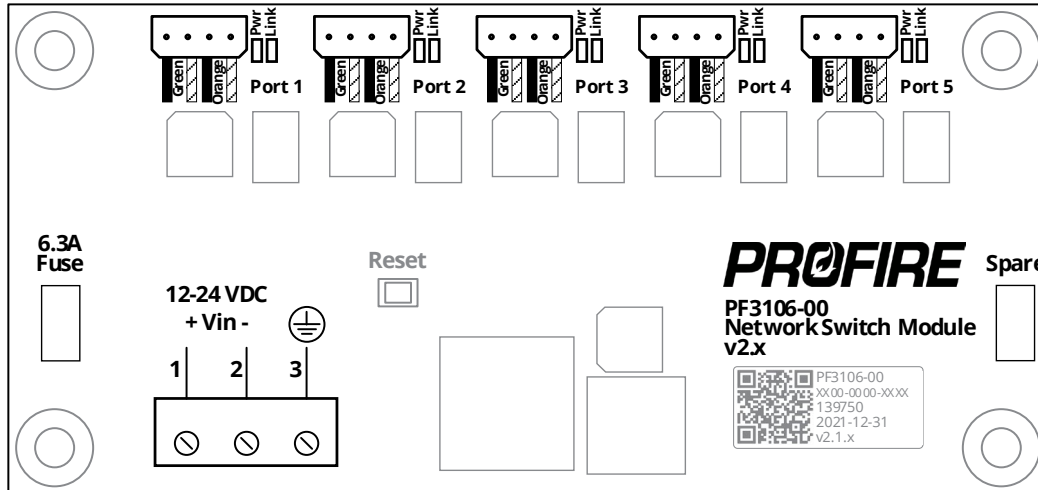

10.1 TERMINAL RATINGS

Name	Safety Rated	Terminal	Input/ Output	Electrical Ratings
Power In	No	1 Vin +	I	12-24 V _{DC} 6.3A maximum *Fused at 6.3A
		2 Vin -		
		3 EGND	GND	
PFRN Network	Yes	Port 1	I/O	36 V _{DC} 1A maximum
		Port 2	I/O	
		Port 3	I/O	
		Port 4	I/O	
		Port 5	I/O	

10.2 POWER INPUT

10.2.1 DETAILS

Terminals	1, 2 & 3
Name	Vin
Type	Power input

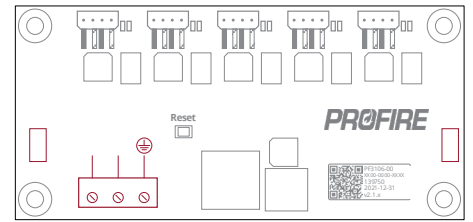

10.2.2 INTENDED FIELD DEVICE CONNECTIONS

Field Device	Configuration Requirements	Connection Diagrams
12V Power Supply	N/A	Power Input Wiring
24V Power Supply		

10.3 PFRN PORTS

10.3.1 DETAILS

Name	Port 1, Port 2, Port 3, Port 4 & Port 5
Type	PFRN bus expansion port (Controller or I/O network)

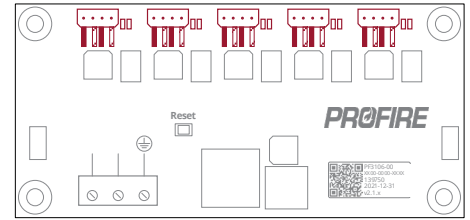

10.3.2 INTENDED FIELD DEVICE CONNECTIONS

Field Device	Configuration Requirements	Connection Diagrams
PF3101-00 BMS card PFRN Controller Network port	N/A	PFRN Connector Wiring UI PFRN Connection Options
PF3101-00 BMS card PFRN I/O Network port	N/A	PFRN Connector Wiring I/O Card PFRN Wiring Options

* Network cards cannot be connected to PFRN Controller Network port(s) and PFRN I/O Network port(s) at the same time. Separate cards must be used when expansion of both the Controller network and I/O network is required.

10.3.3 SYSTEM BEHAVIOR - DIAGNOSTIC LEDS

Name	Color	LED Behavior	Interpretation	Issue/Corrective Action
Pwr	Blue	Off	Port has no power	No Power – Make sure Network card has power supplied to Power Input terminals. Wiring fault – Check PFRN wire terminations at Network card and connected card. Hardware fault – Contact Profire for replacement.
		On – Solid	Port has power	N/A
		On – Flickering	Port has intermittent power	Wiring fault – Check PFRN wire terminations at Network card and connected card. Hardware fault – Contact Profire for replacement.
Link	Green	Off	Port is not communicating	No PFRN Communication – Cycle power to system and check PFRN wire terminations at Network card and connected card.
		On – Solid	Port is communicating normally	N/A
		On – Flickering		

11 PF3107-00 MODBUS CARD

The Modbus Comm card is a PFRN bus expansion and communication card designed to connect between a UI card and one or more BMS controller cards to facilitate the following:

1. PFRN Controller Network expansion to allow additional BMS controller cards to be added to the system.
2. Modbus communication capabilities to each BMS controller card in the system.

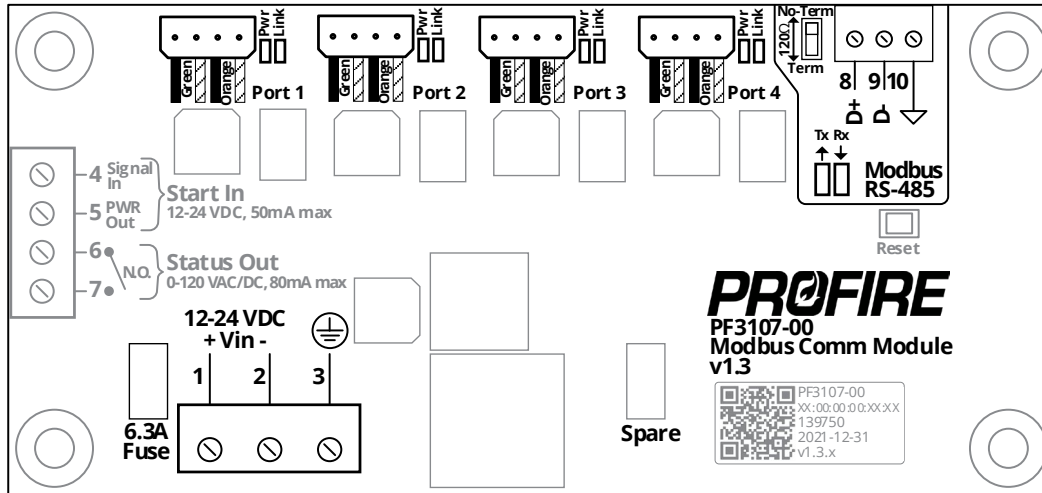

11.1 TERMINAL RATINGS

Name	Safety Rated	Terminal	Input/Output	Electrical Ratings
Power In	No	1 Vin +	I	12-24 V _{DC} 6.3A maximum *Fused at 6.3A
		2 Vin -		
		3 EGND	GND	
Start Input	-	4 Signal In	Not Used	
	5 PWR Out			
Status Output	-	6 N.O. A		
		7 N.O. B		
Modbus RS-485	No	8 D+	I/O	RS-485, -6V – 6V Common Mode Range with reference to terminal 10 (RS-485 GND)
		9 D-		
		10 RS-485 GND		
PFRN Controller Network	Yes	Port 1	I/O	36 V _{DC} 1A maximum
		Port 2	I/O	
		Port 3	I/O	
		Port 4	I/O	

11.2 POWER INPUT

11.2.1 DETAILS

Terminals	1, 2 & 3
Name	Vin
Type	Power input

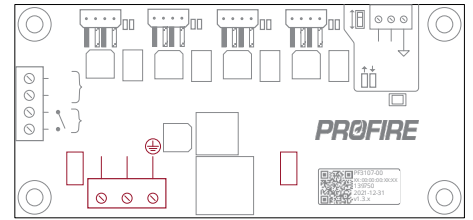

11.2.2 INTENDED FIELD DEVICE CONNECTIONS

Field Device	Configuration Requirements	Connection Diagrams
12V Power Supply	N/A	Power Input Wiring
24V Power Supply		

11.3 START INPUT

11.3.1 DETAILS

Terminals	4 & 5
Name	Start In
Type	Not currently supported

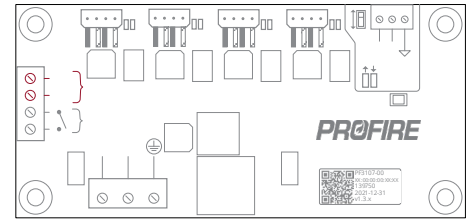

11.3.2 INTENDED FIELD DEVICE CONNECTIONS

Configuration Requirements	Connection Diagrams
<p>Input not currently supported on PF3107-00 Modbus card. Instead, use:</p> <ol style="list-style-type: none"> PF3101-00 BMS Controller card Remote Start input, or Modbus Start/Stop Input/Holding Registers (30100/40100). Refer to PF3107-00 Modbus Register Map for details. 	N/A – Not currently supported

11.4 STATUS OUTPUT

11.4.1 DETAILS

Terminals	6 & 7
Name	Status Out
Type	Not currently supported

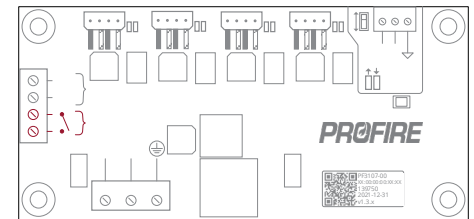

11.4.2 INTENDED FIELD DEVICE CONNECTIONS

Configuration Requirements	Connection Diagrams
<p>Output not currently supported on PF3107-00 Modbus card. Instead, use:</p> <ol style="list-style-type: none"> PF3101-00 BMS Controller card Run Status contact, or PF3113-00 I/O Expansion card Normally Open or Normally Closed Dry Contacts 	N/A – Not currently supported

11.5 MODBUS CONNECTION

11.5.1 DETAILS

Terminals	8, 9 & 10
Name	Modbus RS-485
Protocol	Modbus RTU
Type	RS-485 communication terminals

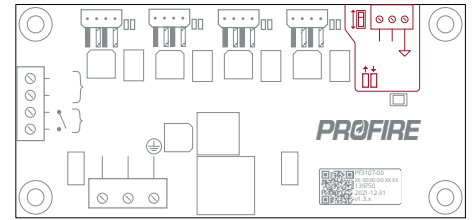

11.5.2 INTENDED FIELD DEVICE CONNECTIONS

Field Device	Configuration Requirements	Connection Diagrams
Modbus Master communication module	<p>PF3100 Controller Configuration No configuration required</p> <p>PF3107-00 Hardware Configuration 120Ω termination resistor switch: As required</p> <p>Modbus Master Configuration Data Bits: 8 Stop Bits: 1 Parity: None Baud rate: 9600 or 19200 * Power cycle of PF3100 is required following a change of the Baud rate.</p> <p>Slave Address: Last byte of BMS controller MAC address from Serial Number Label. e.g., A BMS controller with a MAC address of A0:00:00:00:00:2B has a Modbus address of 2B or 43 in decimal form.</p>	<p>Modbus Input Wiring</p>

Refer to [PF3107-00 Modbus Register Map](#) document for additional Modbus information.

11.6 PFRN PORTS

11.6.1 DETAILS

Name	Port 1, Port 2, Port 3 & Port 4
Type	PFRN Controller Network Ports

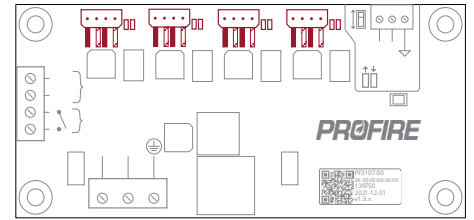

11.6.2 INTENDED FIELD DEVICE CONNECTIONS

Field Device	Configuration Requirements	Connection Diagrams
PF3101-00 BMS card PFRN Controller Network port	N/A	PFRN Connector Wiring UI PFRN Connection Options

11.6.3 SYSTEM BEHAVIOR - DIAGNOSTIC LEDS

Name	Color	LED Behavior	Interpretation	Issue/Corrective Action
Pwr	Blue	Off	Port has no power	No Power – Make sure Modbus card has power supplied to Power Input terminals. Wiring fault – Check PFRN wire terminations at Modbus card and connected card. Hardware fault – Contact Profire for replacement.
		On – Solid	Port has power	N/A
		On – Flickering	Port has intermittent power	Wiring fault – Check PFRN wire terminations at Modbus card and connected card. Hardware fault – Contact Profire for replacement.
Link	Green	Off	Port is not communicating	No PFRN Communication – Cycle power to system and check PFRN wire terminations at Modbus card and connected card.
		On – Solid	Port is communicating normally	N/A
		On – Flickering		

12 PF3113-00 I/O EXPANSION CARD

The IO Expansion card is an I/O card designed to be connected to a BMS controller card to allow (1) monitoring of up to four additional input devices, (2) control of an additional 4-20mA output device and (3) use of two additional configurable status relay contacts.

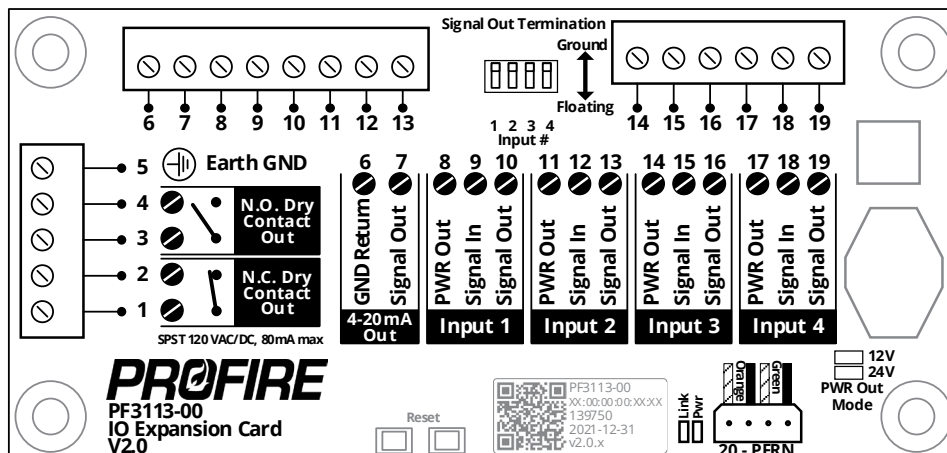

12.1 TERMINAL RATINGS

Name	Safety Rated	Terminal	Input/ Output	Electrical Ratings
Dry Contacts	No	1 N.C. – A	-	Dry contact 120 Vac/V _{DC} 80mA max
		2 N.C. – B		
	Yes	3 N.O. – A		
		4 N.O. – B		
Earth Ground	-	5 EGND	GND	
4-20mA output	No	6 GND Return	O	25mA max, 12V Mode: 14V _{DC} , 24V Mode: 24V _{DC} Maximum output device impedance: 12V Mode: 250Ω, 24V Mode: 900Ω
		7 Signal Out		
Input 1	Yes	8 PWR Out	O	50mA max, 12V Mode: 14V _{DC} , 24V Mode: 24 V _{DC} ,
		9 Signal In	I	Digital Mode: 30 V _{DC} max, 0.7mA minimum wetting current 4-20 Mode: 30 V _{DC} max, 25mA max
	No	10 Signal Out	O	Pass through output 30 V _{DC} max, 25mA max
Input 2	Yes	11 PWR Out	O	50mA max, 12V Mode: 14V _{DC} , 24V Mode: 24 V _{DC} ,
		12 Signal In	I	Digital Mode: 30 V _{DC} max, 0.7mA minimum wetting current 4-20 Mode: 30 V _{DC} max, 25mA max
	No	13 Signal Out	O	Pass through output 30 V _{DC} max, 25mA max
Input 3	Yes	14 PWR Out	O	50mA max, 12V Mode: 14V _{DC} , 24V Mode: 24 V _{DC} ,
		15 Signal In	I	Digital Mode: 30 V _{DC} max, 0.7mA minimum wetting current 4-20 Mode: 30 V _{DC} max, 25mA max
	No	16 Signal Out	O	Pass through output 30 V _{DC} max, 25mA max
Input 4	Yes	17 PWR Out	O	50mA max, 12V Mode: 14V _{DC} , 24V Mode: 24 V _{DC} ,
		18 Signal In	I	Digital Mode: 30 V _{DC} max, 0.7mA minimum wetting current 4-20 Mode: 30 V _{DC} max, 25mA max
	No	19 Signal Out	O	Pass through output 30 V _{DC} max, 25mA max
PFRN I/O Network	Yes	20 PFRN	I/O	36 V _{DC} , 1A maximum

12.2 NORMALLY CLOSED DRY CONTACT

12.2.1 DETAILS

Terminals	1 & 2
Name	N.C. Dry Contact Out
Type	Normally closed dry contact

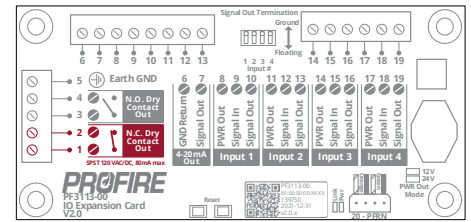

12.2.2 INTENDED FIELD DEVICE CONNECTIONS

The PF3113-00 normally closed contact is not safety rated and cannot be used for safety critical functions.

Field Device	Configuration Requirements	Connection Diagrams
Site equipment status panel	I/O Wizard > I/O Modules Tab N.C. Dry Contact: As desired	Run Status – AC Run Status – DC

12.2.3 NORMALLY CLOSED DRY CONTACT BEHAVIOR

Mode	Condition	Contact State
Disabled	Any	CLOSED
Started Status	No controllers in the appliance are in a running state	CLOSED
	One or more controllers in the appliance are in a running state	OPEN
High Temp Status	No controllers in the appliance have high temperature alarms present	CLOSED
	Any controller in the appliance has a high temperature alarm present	OPEN
No Alert status	Any controller in the appliance has alerts present	CLOSED
	No controllers in the appliance have alerts present	OPEN
Appliance Process Control	No controller in the appliance is in a Process Control state	CLOSED
	Any controller in the appliance is in a Process Control state	OPEN
Controller Process Control	Connected controller is not in a Process Control state	CLOSED
	Connected controller is in a Process Control state	OPEN
Temp Setpoint Trip	Configured temperature input is below its corresponding setpoint *	CLOSED
	Configured temperature input is above its corresponding setpoint	OPEN
Input Setpoint Trip	Configured input is below its corresponding setpoint *	CLOSED
	Configured input is above its corresponding setpoint	OPEN
Purge Status	Connected controller is not Purging	CLOSED
	Connected controller is Purging	OPEN

* Input must go below its configured setpoint minus deadband to transition from Closed to Open

12.3 NORMALLY OPEN DRY CONTACT

12.3.1 DETAILS

Terminals	3 & 4
Name	N.O. Dry Contact Out
Type	Normally open dry contact

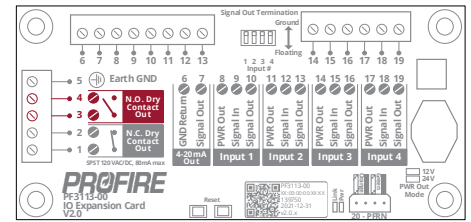

12.3.2 INTENDED FIELD DEVICE CONNECTIONS

Field Device	Configuration Requirements	Connection Diagrams
Site equipment status panel	I/O Wizard > I/O Modules Tab N.O. Dry Contact: As desired	Run Status – AC Run Status – DC

12.3.3 NORMALLY OPEN DRY CONTACT BEHAVIOR

Mode	Condition	Contact State
Disabled	Any	OPEN
Started Status	No controllers in the appliance are in a running state	OPEN
	One or more controllers in the appliance are in a running state	CLOSED
High Temp Status	No controllers in the appliance have high temperature alarms present	OPEN
	Any controller in the appliance has a high temperature alarm present	CLOSED
No Alert status	Any controller in the appliance has alerts present	OPEN
	No controllers in the appliance have alerts present	CLOSED
Appliance Process Control	No controller in the appliance is in a Process Control state	OPEN
	Any controller in the appliance is in a Process Control state	CLOSED
Controller Process Control	Connected controller is not in a Process Control state	OPEN
	Connected controller is in a Process Control state	CLOSED
Temp Setpoint Trip	Configured temperature input is below its corresponding setpoint *	OPEN
	Configured temperature input is above its corresponding setpoint	CLOSED
Input Setpoint Trip	Configured input is below its corresponding setpoint *	OPEN
	Configured input is above its corresponding setpoint	CLOSED
Purge Status	Connected controller is not Purging	OPEN
	Connected controller is Purging	CLOSED

* Input must go below its configured setpoint minus deadband to transition from Closed to Open

12.4 4-20 mA OUTPUT

12.4.1 DETAILS

Terminals	6 & 7
Name	4-20mA Out
Type	4-20mA powered output

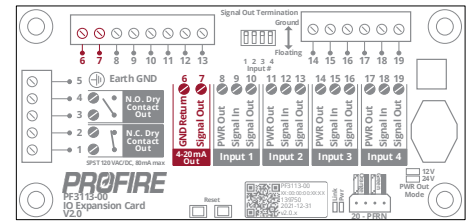

12.4.2 INTENDED FIELD DEVICE CONNECTIONS

The PF3113-00 I/O Expansion card 4-20mA output is not safety rated and cannot be used for safety critical functions.

Field Device	Configuration Requirements	Connection Diagrams
Proportional actuator controlled by PID control on 4-20mA input(s)	<p>I/O Wizard > Add Inputs Tab Create up to four 4-20mA inputs as desired</p> <p>I/O Wizard > I/O Modules Tab Inputs 1-4: Assign as per field wiring 4-20 Output: PID Output Controlled by 4-20mA Input</p> <p>Select I/O Card 4-20 Inputs: Up to four as desired All selected inputs are averaged to determine the input reading used by the PID output.</p> <p>I/O Wizard > Configure PID Parameters Dialog Setpoint: As desired PID Parameters: As desired Direction: As desired Mode: Auto System Stop Output: As desired/required Output Limits: As desired/required</p>	<p>Proportional Valve/Actuator Wiring</p>
Proportional actuator controlled by PID control on thermocouple input(s)	<p>Temperature Wizard > Create Inputs Tab Create up to four temperature inputs as desired * Note that these inputs must be created in the Temperature Wizard rather than in the I/O Wizard</p> <p>I/O Wizard > I/O Modules Tab Inputs 1-4: Assign as per field wiring 4-20 Output: PID Output Controlled by TC Input</p> <p>Select Temperature Inputs: Up to four as desired All selected inputs are averaged to determine the input reading used by the PID output.</p> <p>I/O Wizard > Configure PID Parameters Dialog Setpoint: As desired PID Parameters: As desired Direction: As desired Mode: Auto System Stop Output: As desired/required Output Limits: As desired/required</p>	<p>Proportional Valve/Actuator Wiring</p>

Field Device	Configuration Requirements	Connection Diagrams
FARC air actuator	<p>I/O Wizard > Add Inputs Tab Refer to Configurable I/O Expansion inputs section for instructions on configuring FARC valve and air position feedback inputs Refer to Configurable I/O Expansion inputs section for instructions on configuring an O₂ sensor input if desired.</p> <p>I/O Wizard > I/O Modules Tab 4-20 Output: Air Position Controlled by FARC Name: As desired</p> <p>FARC / O₂ Trim Wizard > General Tab FARC Enable: Enabled All other settings: As desired</p> <p>FARC / O₂ Trim Wizard > Channels Tab > Channel Configuration Menu (Repeat for all channels) All settings: As desired</p> <p>FARC / O₂ Trim Wizard > Channels Tab > Configure Curves Menu Configure FARC table(s) in accordance with safety design documentation and fuel-air ratio profiles.</p> <p>FARC / O₂ Trim Wizard > O₂ Trim Tab All Settings: As per safety design documentation</p> <p>FARC / O₂ Trim Wizard > O₂ Trim Tab > Configure O₂ Curve Menu Configure O₂ curve in accordance with safety design documentation and O₂ Trim profile.</p> <p>Output Calibration Wizard Ensure all outputs are calibrated prior to starting an appliance for use in a FARC application. Refer to Output Calibration Wizard section.</p>	<p>Proportional Valve/Actuator Wiring</p>
FARC aux channel actuator	<p>I/O Wizard > Add Inputs Tab Refer to Configurable I/O Expansion inputs section for instructions on configuring Aux position feedback inputs if required.</p> <p>I/O Wizard > I/O Modules Tab 4-20 Output: Aux Position Controlled by FARC Channel: As desired Name: As desired</p> <p>FARC / O₂ Trim Wizard > Channels Tab > Channel Configuration Menu (Repeat for all channels) All settings: As desired</p> <p>FARC / O₂ Trim Wizard > Channels Tab > Configure Curves Menu Configure FARC table(s) in accordance with safety design documentation and fuel-air ratio profiles.</p> <p>FARC / O₂ Trim Wizard > O₂ Trim Tab All Settings: As per safety design documentation</p> <p>FARC / O₂ Trim Wizard > O₂ Trim Tab > Configure O₂ Curve Menu Configure O₂ curve in accordance with safety design documentation and O₂ Trim profile.</p> <p>Output Calibration Wizard Ensure all outputs are calibrated prior to starting an appliance for use in a FARC application. Refer to Output Calibration Wizard section.</p>	<p>Proportional Valve/Actuator Wiring</p>

12.4.3 4-20mA OUTPUT BEHAVIOR – PID CONTROL

Controller State	System Behavior
Any stopped state	PID is stopped – output is held at the configured System Stop Output position
Any running state	PID is operating – output is changed within the configured Low Output Limit and High Output Limit in accordance with configured PID parameters

12.4.4 4-20mA OUTPUT BEHAVIOR – FARC ACTUATOR

Post Purge Mode	Controller State	Output Signal ^{1,2}
Purge	Any stopped state – post purging	Purge Position
Hold Last		Last position before purge event
Any	Any stopped state – not post purging	Off Position
	Waiting or Startup Checks	Off Position
	Request Purge or Prove Airflow or Pre-Purge	Purge Position
	Request Pilot Position	Pilot Position
	Pilot	Pilot Position
	Pilot - Request Light Off	Light Off Position
	Low Fire	Light Off Position
	Process Control	Normal conditions: FARC table position corresponding to the current firing rate. Cross limiting conditions: FARC table position corresponding to Cross Limiting scheme ^{3,4}

¹ FARC channel output positions are specified separately for each channel.

² Channel output positions are displayed on the UI in % in accordance with the configured channel position settings and the FARC table, but the corresponding mA output values are dependent on the configured Output Inversion setting as follows:
 Disabled: 0% corresponds to 4mA, 100% corresponds to 20mA; Output = (Displayed output reading x 16mA) + 4mA
 Enabled: 0% corresponds to 20mA, 100% corresponds to 4mA; Output = ((100% - Displayed output reading) x 16mA) + 4mA
 Example: A channel output of 75% corresponds to a 4-20mA output of:

- 16mA when direction setting is Disabled ((75% x 16mA) + 4mA).
- 8mA when direction setting is Enabled (((100% - 75%) x 16mA) + 4mA)).

³ Cross limiting is applied to all leading FARC channels when the actual position of a lagging channel exceeds its expected position from the FARC table by ignoring the current firing rate and driving the leading channel outputs to their FARC table values corresponding to the actual position of the lagging channel.

⁴ Cross limiting is applied to all lagging FARC channels when the actual position of a leading channel is less than its expected position from the FARC table by ignoring the current firing rate and driving the lagging channel outputs to their FARC table values corresponding to the actual position of the leading channel.

Example: Current firing rate = 50%, Expected fuel Position = 32%, Actual Fuel Position = 35%

Firing Rate	30	35	40	45	50	55	60	65	70
Fuel (lagging)	20	23	26	29	32	35	38	41	44
Air (leading)	23	28	33	38	43	48	53	58	63

In the example above, the firing rate remains at 50%, the fuel channel output remains at 32% and the air channel output is increased to 48% (the FARC Table value corresponding to a fuel output of 35%).

12.5 CONFIGURABLE I/O EXPANSION INPUTS

12.5.1 DETAILS

Terminals	8/9/10 and 11/12/13 and 14/15/16 and 17/18/19
Name	Input 1 and Input 2 and Input 3 and Input 4
Type	Configurable digital or 4-20mA inputs

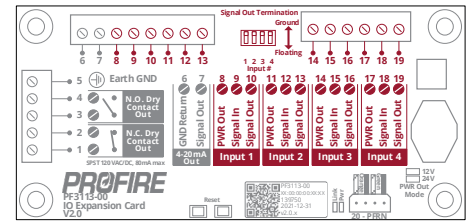

12.5.2 INTENDED FIELD DEVICE CONNECTIONS

Field Device/Application	Configuration Requirements	Connection Diagrams
Digital fuel pressure switch	I/O Wizard > Add Inputs Tab Input Type: As per device type Signal Type: Digital Input Mode: As desired Name: As per equipment tag I/O Wizard > I/O Modules Tab Input 1-4: Assign as per field wiring Module Voltage: As required per device ratings	Digital Input – Dry Contact Digital Input – Wet Contact
Digital flow switch		
Digital level switch		
Generic digital input switch		
4-20mA fuel pressure transmitter	I/O Wizard > Add Inputs Tab Input Type: As per device type (use Custom for temperature inputs) Signal Type: 4-20 Name: As per equipment tag All other settings: As desired I/O Wizard > I/O Modules Tab Input 1-4: Assign as per field wiring Transmitter Span Low: Reading corresponding to a 4mA transmitter output signal Transmitter Span High: Reading corresponding to a 20mA transmitter output signal Module Voltage: As required per device ratings	Loop Powered Transmitter Self Powered Transmitter 4-20mA Echo to PLC
4-20mA flow transmitter		
4-20mA level transmitter		
4-20mA temperature transmitter		
Generic 4-20mA transmitter		
Secondary PID control input		
PID Staging Input		
External firing rate signal from PLC	I/O Wizard > Add Inputs Tab Input Type: Appliance Firing Rate All other settings: Ignored I/O Wizard > I/O Modules Tab Input 1-4: As per field wiring All other settings: As desired Refer to BMS Controller Card Aux Output section for additional configuration details and output behavior.	Analog Input from PLC

Field Device/Application	Configuration Requirements	Connection Diagrams
FARC valve position feedback input	<p>I/O Wizard > Add Inputs Tab Input Type: FARC Valve Position All other settings: Ignored</p> <p>I/O Wizard > I/O Modules Tab Input 1-4: As per field wiring All other settings: As desired</p> <p>FARC / O₂ Trim Wizard > General Tab FARC Enable: Enabled All other settings: As required per safety design documentation</p>	<p>Loop Powered Transmitter Self Powered Transmitter</p>
FARC air position feedback input	<p>I/O Wizard > Add Inputs Tab Input Type: FARC Air Position All other settings: Ignored</p> <p>I/O Wizard > I/O Modules Tab Input 1-4: As per field wiring 4-20 Output: Air Position Controlled by FARC All other settings: As desired</p> <p>FARC / O₂ Trim Wizard > General Tab FARC Enable: Enabled All other settings: As required per safety design documentation</p>	<p>Loop Powered Transmitter Self Powered Transmitter</p>
FARC Aux channel position feedback input	<p>I/O Wizard > Add Inputs Tab Input Type: CHx Feedback Position All other settings: Ignored</p> <p>I/O Wizard > I/O Modules Tab Input 1-4: As per field wiring 4-20 Output: CHx Position Controlled by FARC All other settings: As desired</p> <p>FARC / O₂ Trim Wizard > General Tab FARC Enable: Enabled All other settings: As required per safety design documentation</p> <p>FARC /Or Trim Wizard > Channels Tab > Channel Configuration Menu Position Feedback: Select appropriate channel</p>	<p>Loop Powered Transmitter Self Powered Transmitter</p>
Bleed valve proof of open switch(es)	<p>I/O Wizard > Add Inputs Tab Input Type: Bleed Valve Proof of Open All other settings: Ignored</p> <p>I/O Wizard > I/O Modules Tab * Input 1-4: As per field wiring All other settings: As desired</p> <p>* Input applies only to the BMS controller card to which it is connected (via I/O Expansion card). Multi-BMS applications require each BMS to have a dedicated I/O Expansion card connected with the single Bleed Valve Proof of Open logical input assigned.</p>	<p>Digital Input – Dry Contact Digital Input – Wet Contact</p>

Field Device/Application	Configuration Requirements	Connection Diagrams
<p>Oxygen sensor</p>	<p>I/O Wizard > Add Inputs Tab Input Type: O₂ Sensor Reading Name: As per equipment tag Units: As desired I/O Wizard > I/O Modules Tab Input 1-4: As per field wiring All other settings: As desired FARC / O₂ Trim Wizard > O₂ Trim Tab All Settings: As per safety design documentation FARC / O₂ Trim Wizard > O₂ Trim Tab > Configure O₂ Curve Menu Configure O₂ curve in accordance with safety design documentation and O₂ Trim profile.</p>	<p>Loop Powered Transmitter Self Powered Transmitter</p>
<p>4-20mA transmitter with separate low trip and high trip behavior</p> <p>* This application is not safety rated. Separate devices must be used to maintain safety rating.</p>	<p>I/O Wizard > Add Inputs Tab Input 1: Input Type: As per device type Signal Type: 4-20 Input Mode: Desired high trip behavior Low Setpoint: Set to transmitter 4mA position High Trip Setpoint: As desired All other settings: As desired Input 2: Input Type: Same as above Signal Type: 4-20 Input Mode: Desired low trip behavior Low Setpoint: As desired High Trip Setpoint: Set to transmitter 20mA position All other settings: As desired I/O Wizard > I/O Modules Tab Input 1: Assign Input 1 from above Input 2: Assign Input 2 from above All other settings: As desired PF3113 Hardware Configuration DIP Switch 1: Floating DIP Switch 2: Ground</p>	<p>Single Transmitter to Multiple Inputs</p>

12.5.3 SYSTEM BEHAVIOR – IO EXPANSION CARD DIGITAL INPUT

Scenario			State Transition	Controller Alerts
Input Mode	Controller State	Input state (see warning below for applications using redundant inputs)		
Any except Proof of Airflow	Any	Energized	No effect	N/A
Alarm	Any stopped state	De-energized	Alarm	IO Expansion Digital Input Open alarm
	Any running state	De-energized	Lockout	IO Expansion Digital Input Open alarm
Wait	Any stopped state	De-energized	No effect	IO Expansion Digital Input Open wait
	Any running state	De-energized	Waiting	IO Expansion Digital Input Open wait
Warning	Any	De-energized	No effect	IO Expansion Digital Input Open warning
Main Permissive	Any non-main state	De-energized	No effect	IO Expansion Digital Input Open main permissive
	Any main fuel state	De-energized	Pilot ¹	IO Expansion Digital Input Open main permissive
Display Only	Any	De-energized	No effect	N/A
Local Proof of Airflow	Refer to Proof of Airflow Behavior table below for system behavior			

¹ When Pilot Off mode is set to Off After Main On, the controller transitions to the Waiting state, then purges the system before reigniting and proceeding to Pilot.



The following is for applications that have multiple input devices monitoring a single controller input (i.e., input redundancy), that is, a single created input (I/O Expansion Wizard > Add Inputs Tab) is assigned to more than one card input slot (I/O Expansion Wizard > I/O Modules Tab):
 Warning - I/O Expansion input redundancy is supported for hardware redundancy only (i.e., the system continues to run if a redundant input loses communication with the BMS controller, but the redundant input state is determined by a single input only). The input state of the redundant input is determined by the first input to establish communication with the BMS controller only.

12.5.4 SYSTEM BEHAVIOR – IO EXPANSION CARD 4-20mA INPUT

Scenario			State Transition	Controller Alerts
Input Mode	Controller State	Input state (see warning below for applications using redundant inputs)		
Any except Proof of Airflow	Any	Not tripped	No effect	N/A
Any ¹	Any	Out of Range	Alarm/Lockout	IO Expansion Input Invalid alarm
Alarm	Any stopped state	Low Trip	Alarm	IO Expansion Analog Input Low alarm
		High Trip	Alarm	IO Expansion Analog Input High alarm
	Any running state	Low Trip	Lockout	IO Expansion Analog Input Low alarm
		High Trip	Lockout	IO Expansion Analog Input High alarm
Wait	Any stopped state	Low Trip	No effect	IO Expansion Analog Input Low wait
		High Trip	No effect	IO Expansion Analog Input High wait
	Any running state	Low Trip	Waiting	IO Expansion Analog Input Low wait
		High Trip	Waiting	IO Expansion Analog Input High wait
Warning	Any	Low Trip	No effect	IO Expansion Analog Input Low warning
		High Trip	No effect	IO Expansion Analog Input High warning
Main Permissive	Any non-main state	Low Trip	No effect	IO Expansion Analog Input Low main permissive
		High Trip	No effect	IO Expansion Analog Input High main permissive
	Any main fuel state	Low Trip	Pilot ²	IO Expansion Analog Input Low main permissive
		High Trip	Pilot ²	IO Expansion Analog Input High main permissive
Display Only	Any	Any	No effect	N/A
Local Proof of Airflow	Refer to Proof of Airflow Behavior table below for system behavior			
Secondary PID Input	Refer to PID Tuning Guide document for advanced PID system behavior			

¹ Except in Display Only or Warning states.

² When Pilot Off mode is set to Off After Main On, the controller transitions to the Waiting state, then purges the system before reigniting and proceeding to Pilot.



The following is for applications that have multiple input devices monitoring a single controller input (i.e., input redundancy), that is, a single created input (I/O Expansion Wizard > Add Inputs Tab) is assigned to more than one card input slot (I/O Expansion Wizard > I/O Modules Tab):
 Warning - I/O Expansion input redundancy is supported for hardware redundancy only (i.e., the system continues to run if a redundant input loses communication with the BMS controller or goes out of range, but the redundant input state is determined by a single input only). The input state of the redundant input is determined by the first input to establish communication with the BMS controller only.

12.5.5 SYSTEM BEHAVIOR – IO EXPANSION CARD LOCAL PROOF OF AIRFLOW INPUT

This section is for a proof of airflow input wired to an I/O Expansion card. Refer to [System Behavior – BMS Card Aux In Proof of Airflow](#) section for a proof of airflow input wired to a BMS Controller card. Proof of Airflow inputs apply only to the BMS controller card to which they are connected (either directly through the BMS Aux In contact or through an I/O Expansion card). Each BMS requiring a Proof of Airflow input must have either (1) a proof of airflow switch wired to its Aux In contact or (2) a proof of airflow device wired to a dedicated I/O Expansion card with a single logical Local Proof of Airflow input.

Signal Type setting	HFV Output Mode setting	Controller State	Input State	State Transition	Controller Alerts	
Digital	Any	Startup Checks	Energized	Lockout	Airflow Input Stuck	
			De-energized	Pre-Purge	N/A	
		Proven Pre-Purge	Energized	No effect	N/A	
			De-energized	Lockout	Failed to Prove Airflow While Purging	
	Forced Draft Fan	Any fuel state	Energized	No effect	N/A	
			De-energized	Lockout	Failed to Prove Airflow While Running	
	Purge Fan	Any fuel state	Any	No effect	N/A	
4-20	Any	Any	Out of Range	Alarm/ Lockout	I/O Expansion POAF Input Invalid alarm	
			Any			High Trip
		Startup Checks	Valid range ¹	Lockout	Airflow Input Stuck	
			Low Trip	Pre-Purge	N/A	
		Proven Pre-Purge	Valid range ¹	No effect	N/A	
			Low Trip	Lockout	Failed to Prove Airflow While Purging	
		Forced Draft Fan	Any fuel state	Valid range ¹	No effect	N/A
				Low Trip	Lockout	Failed to Prove Airflow While Running
	Purge Fan	Any fuel state	Valid range ¹	No effect	N/A	
			Low Trip	No effect	N/A	

¹ An input is in the valid range when it is above the configured Low Trip setting and below the configured High Trip setting.

12.5.6 SYSTEM BEHAVIOR – FARC POSITION FEEDBACK INPUT

Scenario			State Transition	Controller Alerts
Input Signal	Cross Limit Error	Controller State		
Out of Range	Any	Any running	Lockout	IO Expansion Invalid alarm
		Any stopped	Alarm	
Within position error of expected position	Below Cross Limit Error setting	Any	No effect	N/A
Outside position error of expected position		Any running	Lockout	FARC Fuel Channel Position
		Any stopped	Alarm	
Any		Above Cross Limit Error setting	Any running	Lockout
	Any stopped		Alarm	

12.5.7 SYSTEM BEHAVIOR – BLEED VALVE PROOF OF OPEN INPUT

Scenario		State Transition	Controller Alerts
Controller state	Input State		
Any non-main state	Energized	No effect	N/A
	De-energized	Alarm/Lockout	Bleed Valve Closed With Mains Off alarm
Any main state	Energized	Lockout	Bleed Valve Open With Mains On alarm
	De-energized	No effect	N/A

12.5.8 SYSTEM BEHAVIOR – OXYGEN SENSOR INPUT

Scenario			State Transition	O ₂ Trim Controller behavior	Controller Alerts
Controller State	Warmup complete ¹	Input State			
Process Control	Yes	Above High Setpoint	N/A	Actively trimming to achieve Target O ₂ Setpoint ²	High Measured %O ₂ warning
		Above Target O ₂ Value	N/A	Actively trimming to achieve Target O ₂ Setpoint ²	O ₂ Trim at Limit warning * If at Max Trim value
		At Target O ₂ Value	N/A	Not trimming	N/A
		Below Target O ₂ Value	N/A	Actively trimming to achieve Target O ₂ Setpoint ²	O ₂ Trim at Limit warning * If at Min Trim value
		Below Low Setpoint	Lockout	Not trimming	Low %O ₂ alarm
	No	Any	N/A	Not trimming	N/A
Not Process Control	No	Any	N/A	Not trimming	N/A

¹ The O₂ Trim warmup period is determined in accordance with the Warmup Mode setting (FARC/O₂ Trim Wizard > O₂ Trim Tab).

² In accordance with the configured Trim Channel setting, O₂ Proportional Band setting, O₂ Integral Time setting and O₂ Trim table limits (FARC/O₂ Trim Wizard > O₂ Trim Tab). Trimming consists of applying an offset to the output value of the configured Trim Channel to achieve the configured Target O₂ value for the current firing rate of the system.

12.6 PFRN PORT

12.6.1 DETAILS

Terminals	20
Name	PFRN
Type	PFRN I/O Network Port

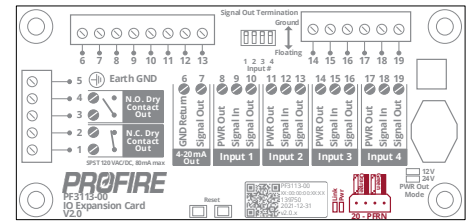

12.6.2 INTENDED FIELD DEVICE CONNECTIONS

Field Device	Configuration Requirements	Connection Diagrams
PF3101-00 BMS card PFRN I/O Network port	N/A	PFRN Connector Wiring I/O Card PFRN Wiring Options

12.6.3 SYSTEM BEHAVIOR – DIAGNOSTIC LEDS

Name	Color	LED Behavior	Interpretation	Issue/Corrective Action
Pwr	Blue	Off	Port has no power	No BMS Power – Make sure BMS Controller card is powered on. Wiring fault – Check PFRN wire terminations at BMS and I/O Expansion card. Hardware fault – Contact Profire for replacement.
		On – Solid	Port has power	N/A
		On – Flickering	Port has intermittent power	Wiring fault – Check PFRN wire terminations at BMS and I/O Expansion card. Hardware fault – Contact Profire for replacement.
Link	Green	Off/flickering	Port is not communicating	No PFRN Communication – Cycle power to BMS card and check PFRN wire terminations at BMS and I/O Expansion card.
		On – Solid	Port is communicating normally	N/A

12.6.4 SYSTEM BEHAVIOR UPON COMMUNICATION LOSS

Refer to [BMS PFRN I/O Network System Behavior](#) for behavior under communication loss conditions.

13 OPERATING SEQUENCE

The PF3100 utilizes a state-based control scheme to monitor the system and control all safety outputs. Each state has specific entry and exit requirements and defined output behavior. The sections below outline the state transitions and safety output behavior for each controller state. Each BMS controller in an appliance operates independently in accordance with the operating sequence detailed below.

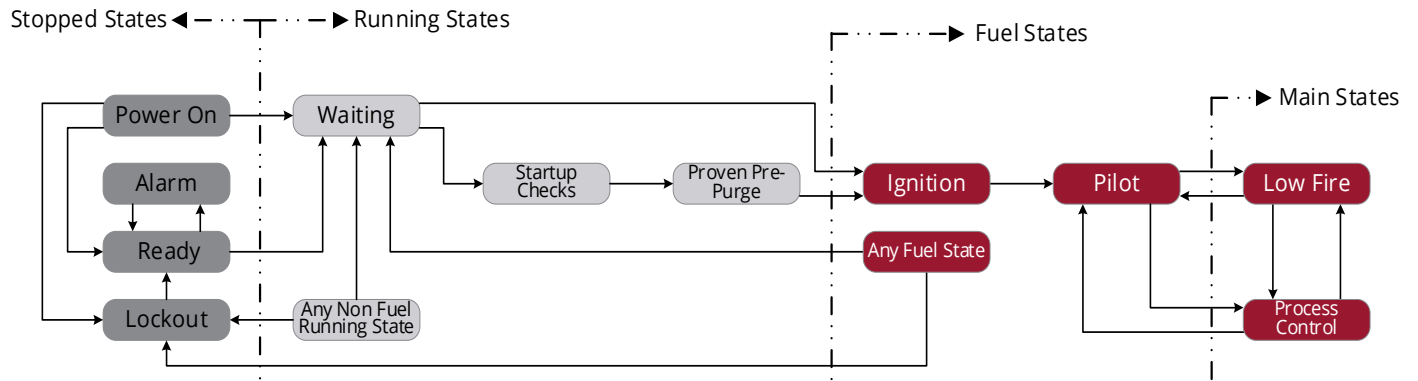

State	Stopped State	Running State	Fuel State	Main State
Power On	YES	NO	NO	NO
Alarm	YES	NO	NO	NO
Ready	YES	NO	NO	NO
Lockout	YES	NO	NO	NO
Waiting	NO	YES	NO	NO
Startup Checks	NO	YES	NO	NO
Proven Pre-Purge	NO	YES	NO	NO
Ignition	NO	YES	YES	NO
Pilot	NO	YES	YES	NO
Low Fire	NO	YES	YES	YES
Process Control	NO	YES	YES	YES

13.1 POWER ON STATE

The controller always enters the Power On state upon power up. All safety outputs are held de-energized, and a purge event is triggered upon entry into the state. The controller quickly transitions out of the Power On state in accordance with the state transition tables below.

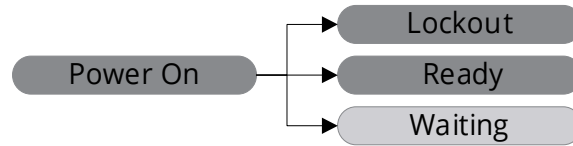

13.1.1 SAFETY OUTPUT BEHAVIOR - POWER ON STATE

Card	Output	Output State
PF3101-00 BMS Controller card	Pilot	De-energized
	SSV1	De-energized
	SSV2	De-energized
PF3102-00 Ion Pilot card	Valve	De-energized
	Coil	De-energized
PF3102-01 UV Pilot card	Ignition Enable	Open

13.1.2 TRANSITIONS TO THE POWER ON STATE

From	Scenario	Condition
Power Off	Any	Any

13.1.3 TRANSITIONS FROM THE POWER ON STATE

To	Scenario	Condition
Lockout	Any	Unacknowledged lockout message present
Alarm * via Ready	Any	Alarm condition present
Ready	Controller was not running at last power down	Low Voltage Restart setting is set to Enabled , AND No alarm conditions present
	Any	Low Voltage Restart setting is set to Disabled , AND No alarm conditions or unacknowledged lockout messages present
Waiting	Controller was running at last power down	Low Voltage Restart setting is set to Enabled , AND No alarm conditions or unacknowledged lockout messages present

13.2 ALARM STATE

The controller transitions to the Alarm state when (1) an alarm condition is present and (2) the controller is not running. The controller cannot transition out of the Alarm state until all alarm conditions are cleared. All safety outputs are held de-energized while the controller is in the Alarm state.



13.2.1 SAFETY OUTPUT BEHAVIOR - ALARM STATE

Card	Output	Output State
PF3101-00 BMS Controller card	Pilot	De-energized
	SSV1	De-energized
	SSV2	De-energized
PF3102-00 Ion Pilot card	Valve	De-energized
	Coil	De-energized
PF3102-01 UV Pilot card	Ignition Enable	Open

13.2.2 TRANSITIONS TO THE ALARM STATE

From	Scenario	Condition
Ready	Any	Alarm condition present
Power On * via Ready	Any	Alarm condition present
Lockout * via Ready	Lockout message acknowledged by user	Alarm condition present

13.2.3 TRANSITIONS FROM THE ALARM STATE

To	Scenario	Condition
Ready	Any	No alarm conditions present

13.3 READY STATE

The controller transitions to the Ready state when all alarm conditions are cleared and holds all safety outputs de-energized. A user can only start the controller from the Ready state.



13.3.1 SAFETY OUTPUT BEHAVIOR - READY STATE

Card	Output	Output State
PF3101-00 BMS Controller card	Pilot	De-energized
	SSV1	De-energized
	SSV2	De-energized
PF3102-00 Ion Pilot card	Valve	De-energized
	Coil	De-energized
PF3102-01 UV Pilot card	Ignition Enable	Open

13.3.2 TRANSITIONS TO THE READY STATE

From	Scenario	Condition
Power On	Controller was not running at last power down	Low Voltage Restart setting is set to Enabled , AND No alarm conditions present
	Any	Low Voltage Restart setting is set to Disabled , AND No alarm conditions or unacknowledged lockout messages present
Lockout	Lockout message acknowledged by user	Any
Alarm	Any	No alarm conditions present

13.3.3 TRANSITIONS FROM THE READY STATE

To	Scenario	Condition
Alarm	Any	Alarm condition present
Waiting	Controller started by user	Any

13.4 LOCKOUT STATE

The controller transitions to the Lockout state (1) when there is an alarm condition present while the system is running and (2) upon power up when there is an unacknowledged lockout message present when the system was last powered down. The safety outputs are held de-energized, and a purge event is initiated upon entry into the state.



13.4.1 SAFETY OUTPUT BEHAVIOR - LOCKOUT STATE

Card	Output	Output State
PF3101-00 BMS Controller card	Pilot	De-energized
	SSV1	De-energized
	SSV2	De-energized
PF3102-00 Ion Pilot card	Valve	De-energized
	Coil	De-energized
PF3102-01 UV Pilot card	Ignition Enable	Open

13.4.2 TRANSITIONS TO THE LOCKOUT STATE

From	Scenario	Condition
Power On	Any	Unacknowledged lockout message present
Waiting	Any	Alarm condition present
	Controller stopped by user	Any
Startup Checks	Any	Alarm condition present
	Controller stopped by user	Any
	Airflow detected	Any
Pre-Purge	Any	Alarm condition present
	Controller stopped by user	Any
	Purge position not proven	Controller not in Request Pilot Position sub-state
	Airflow not proven	Controller in Prove Airflow or Pre-Purge sub-state
	Pilot position not proven	Controller in Request Pilot Position sub state
Ignition	Any	Alarm condition present
	Controller stopped by user	Any
	Pilot ignition failure	Pilot ignition has failed 3 consecutive times
	Flame loss	Relight Attempts setting exceeded
	Flame detected upon transition into Ignition state	Any
Pilot	Any	Alarm condition present
	Controller stopped by user	Any
	Flame loss	Relight Attempts setting exceeded
	Light Off Position not proven	Controller is in Request Light Off Position sub state, AND Position Error Timeout setting has elapsed
Low Fire OR Process Control	Any	Alarm condition present
	Controller stopped by user	Any
	Flame loss	Relight Attempts setting exceeded

13.4.3 TRANSITIONS FROM THE LOCKOUT STATE

To	Scenario	Condition
Ready	Lockout message acknowledged	Any
Alarm via Ready	Lockout message acknowledged	Alarm condition present

13.5 WAITING STATE

The controller transitions to the Waiting state when (1) the controller is started from a stopped state or (2) a wait condition in present while in a running state. Waiting is a running state that holds all safety outputs de-energized. A purge event is triggered when entering the Waiting state from a fuel state.

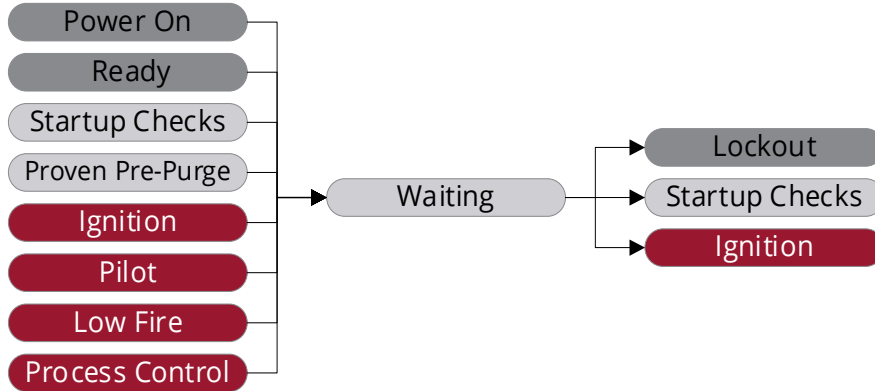

13.5.1 SAFETY OUTPUT BEHAVIOR - WAITING STATE

Card	Output	Output State
PF3101-00 BMS Controller card	Pilot	De-energized
	SSV1	De-energized
	SSV2	De-energized
PF3102-00 Ion Pilot card	Valve	De-energized
	Coil	De-energized
PF3102-01 UV Pilot card	Ignition Enable	Open

13.5.2 TRANSITIONS TO THE WAITING STATE

From	Scenario	Condition
Power On	Controller was running at last power down	Low Voltage Restart setting is set to Enabled , AND No alarm conditions or unacknowledged lockout messages present
Ready	User start	Any
Startup Checks Pre-Purge	Any	Wait condition present
Ignition	Any	Wait condition present
	Pilot Ignition failure	Pilot ignition has failed less than 3 times consecutively
	Flame loss	Relight Attempts setting has not been exceeded
Pilot	Any	Wait condition present
	Flame loss	Relight Attempts setting has not been exceeded
Low Fire	Any	Wait condition present
	Any	Main permissive condition present, AND Pilot Off Mode setting is set to Off after Main On or Follow Main
	Flame loss	Relight Attempts setting has not been exceeded
	Process temperature is above its configured Low Fire setpoint	Pilot Off Mode setting is set to Off after Main On or Follow Main
Process Control - High Fire	Any	Wait condition present
	Any	Main permissive condition present, AND Pilot Off Mode setting is set to Off after Main On or Follow Main
	Flame loss	Relight Attempts setting has not been exceeded
	Process temperature is above its configured Process setpoint	Low Fire Mode setting is set to Disabled , AND Pilot Off Mode setting is set to Off after Main On or Follow Main
Process Control - Incinerate	Any	Wait condition present
	Any	Main permissive condition present, AND Pilot Off Mode setting is set to Off after Main On or Follow Main
	Flame loss	Relight Attempts setting has not been exceeded
Process Control - Incinerate No Assist	Any	Wait condition present
	Any	Main permissive condition present, AND Pilot Off Mode setting is set to Off after Main On or Follow Main
	Flame loss	Relight attempts setting has not been exceeded
	Process temperature is above its configured Waste Gas Off setpoint	Pilot Off Mode setting is set to Off after Main On or Follow Main
Process Control - PID Control	Any	Wait condition present
	Any	Main permissive condition present, AND Pilot Off Mode setting is set to Off after Main On or Follow Main
	Flame loss	Relight Attempts setting has not been exceeded
	Process temperature is above its configured Process setpoint and below its Low Fire setpoint	Low Heat Standby Mode setting is set to Wait , AND Low Heat Standby Delay has elapsed
	Process temperature is above its configured Low Fire setpoint	Pilot Off Mode setting is set to Off after Main On or Follow Main

13.5.3 TRANSITIONS FROM THE WAITING STATE

To	Scenario	Condition
Lockout	Any	Alarm condition present
	Controller stopped by user	Any
Startup Checks	Any	FARC Enable setting is Enabled , AND No alarm or wait conditions present
Ignition	Any	FARC Enable setting is Disabled , AND No alarm or wait conditions present

13.6 STARTUP CHECKS STATE

The controller transitions to the Startup Checks state when the system is configured for FARC applications. It is to ensure that the airflow monitoring device is not stuck open prior to pre-purging. It is a running state that holds all safety outputs de-energized.



13.6.1 SAFETY OUTPUT BEHAVIOR – STARTUP CHECKS STATE

Card	Output	Output State
PF3101-00 BMS Controller card	Pilot	De-energized
	SSV1	De-energized
	SSV2	De-energized
PF3102-00 Ion Pilot card	Valve	De-energized
	Coil	De-energized
PF3102-01 UV Pilot card	Ignition Enable	Open

13.6.2 TRANSITIONS TO THE STARTUP CHECKS STATE

From	Scenario	Condition
Waiting	Any	FARC Enable setting is Enabled , AND No alarm or wait conditions present
N/A - State skipped entirely		FARC Enable setting is Disabled

13.6.3 TRANSITIONS FROM THE STARTUP CHECKS STATE

To	Scenario	Condition
Lockout	Any	Alarm condition present
	Controller stopped by user	Any
	Airflow detected	Any
Waiting	Any	Wait condition present
Proven Pre-Purge	Absence of airflow proven	No alarm or wait conditions present

13.7 PROVEN PRE-PURGE SEQUENCE

The Proven Pre-Purge sequence is a collection of sub-states that ensures a proper pre-purge for all forced draft heating applications. The safety outputs are held de-energized through all the Proven Pre-Purge sub-states. The sub-states are detailed in the sections below:

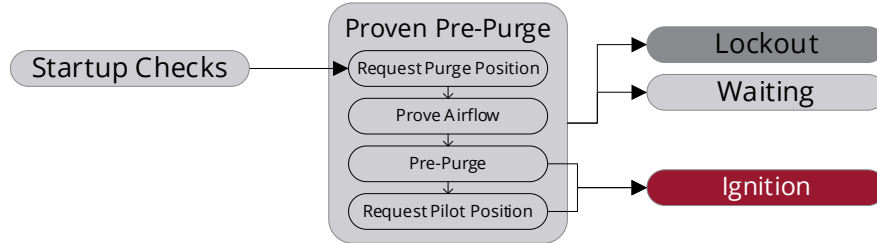

13.7.1 REQUEST PURGE POSITION STATE

The controller transitions to the Request Purge Position sub-state to ensure that all FARC channel outputs are driven to their respective Purge Positions before initiating a pre-purge. All safety outputs are held de-energized for the duration of the Request Purge Position sub-state.

13.7.1.1 SAFETY OUTPUT BEHAVIOR – REQUEST PURGE POSITION STATE

Card	Output	Output State
PF3101-00 BMS Controller card	Pilot	De-energized
	SSV1	De-energized
	SSV2	De-energized
PF3102-00 Ion Pilot card	Valve	De-energized
	Coil	De-energized
PF3102-01 UV Pilot card	Ignition Enable	Open

13.7.1.2 TRANSITIONS TO THE REQUEST PURGE POSITION STATE

From	Scenario	Condition
Startup Checks	Absence of airflow proven	No alarm or wait conditions present

13.7.1.3 TRANSITIONS FROM THE REQUEST PURGE POSITION STATE

To	Scenario	Condition
Lockout	Any	Alarm condition present
	Controller stopped by user	Any
	Purge position not proven	Any
Waiting	Any	Wait condition present
Prove Airflow	Purge position proven	No alarm or wait conditions present

13.7.2 PROVE AIRFLOW STATE

The controller transitions to the Prove Airflow sub-state to energize the fan (HFV) output and ensure that adequate airflow is detected before proceeding with the pre-purge sequence. All safety outputs are held de-energized for the duration of the Prove Airflow sub-state.

13.7.2.1 SAFETY OUTPUT BEHAVIOR – PROVE AIRFLOW STATE

Card	Output	Output State
PF3101-00 BMS Controller card	Pilot	De-energized
	SSV1	De-energized
	SSV2	De-energized
PF3102-00 Ion Pilot card	Valve	De-energized
	Coil	De-energized
PF3102-01 UV Pilot card	Ignition Enable	Open

13.7.2.2 TRANSITIONS TO THE PROVE AIRFLOW STATE

From	Scenario	Condition
Request Purge Position	Purge position proven	No alarm or wait conditions present

13.7.2.3 TRANSITIONS FROM THE PROVE AIRFLOW STATE

To	Scenario	Condition
Lockout	Any	Alarm condition present
	Controller stopped by user	Any
	Purge position not proven	Any
	Airflow not proven	Any
Waiting	Any	Wait condition present
Pre-Purge	Airflow has been proven	No alarm or wait conditions present

13.7.3 PRE-PURGE STATE

The controller transitions to the Pre-Purge sub-state to ensure that adequate airflow is detected for the duration of the pre-purge time. The fan (HFV) output is held energized, and the output positioners are held at their respective purge positions. All safety outputs are held de-energized for the duration of the Pre-Purge sub-state.

13.7.3.1 SAFETY OUTPUT BEHAVIOR – PRE-PURGE STATE

Card	Output	Output State
PF3101-00 BMS Controller card	Pilot	De-energized
	SSV1	De-energized
	SSV2	De-energized
PF3102-00 Ion Pilot card	Valve	De-energized
	Coil	De-energized
PF3102-01 UV Pilot card	Ignition Enable	Open

13.7.3.2 TRANSITIONS TO THE PRE-PURGE STATE

From	Scenario	Condition
Prove Airflow	Airflow has been proven	No alarm or wait conditions present

13.7.3.3 TRANSITIONS FROM THE PRE-PURGE STATE

To	Scenario	Condition
Lockout	Any	Alarm condition present
	Controller stopped by user	Any
	Airflow not proven for duration of purge	Any
	Purge position not proven for duration of purge	Any
Waiting	Any	Wait condition present
Request Pilot Position	Pre-purge has completed successfully	FARC enabled, AND No alarm or wait conditions present
Ignition	Pre-purge has completed successfully	FARC disabled, AND No alarm or wait conditions present

13.7.4 REQUEST PILOT POSITION STATE

The controller transitions to the Request Pilot Position sub-state after a successful pre-purge. The fan (HFV) output remains energized, and all FARC channel outputs are driven to their respective Pilot Positions. All safety outputs are held de-energized for the duration of the Request Pilot Position sub-state.

13.7.4.1 SAFETY OUTPUT BEHAVIOR – REQUEST PILOT POSITION STATE

Card	Output	Output State
PF3101-00 BMS Controller card	Pilot	De-energized
	SSV1	De-energized
	SSV2	De-energized
PF3102-00 Ion Pilot card	Valve	De-energized
	Coil	De-energized
PF3102-01 UV Pilot card	Ignition Enable	Open

13.7.4.2 TRANSITIONS TO THE REQUEST PILOT POSITION STATE

From	Scenario	Condition
Pre-Purge	Pre-purge has completed successfully	No alarm or wait conditions present

13.7.4.3 TRANSITIONS FROM THE REQUEST PILOT POSITION STATE

To	Scenario	Condition
Lockout	Any	Alarm condition present
	Controller stopped by user	Any
	Pilot position not proven	Any
Waiting	Any	Wait condition present
Ignition	Pilot position proven	No alarm or wait conditions present

13.8 IGNITION STATE

The controller transitions to the Ignition state to initiate pilot light off for all connected pilot cards. The Ignition state is a fuel state that energizes the pilot valve outputs and ignition outputs but holds all main valve outputs de-energized. Successful pilot ignition is required for the controller to transition into any other fuel state.



13.8.1 SAFETY OUTPUT BEHAVIOR - IGNITION STATE

Card	Output	Output State
PF3101-00 BMS Controller card	Pilot	Energized
	SSV1	De-energized
	SSV2	De-energized
PF3102-00 Ion Pilot card	Valve	Energized
	Coil	Energized
PF3102-01 UV Pilot card	Ignition Enable	Closed

13.8.2 TRANSITIONS TO THE IGNITION STATE

From	Scenario	Condition
Waiting	Any	FARC Enable setting is Disabled , AND No alarm or wait conditions present
Proven Pre-Purge	Pre-purge sequence completed successfully	No alarm or wait conditions present

13.8.3 TRANSITIONS FROM THE IGNITION STATE

To	Scenario	Condition
Lockout	Any	Alarm condition present
	Controller stopped by user	Any
	Pilot ignition failure	Pilot ignition has failed 3 consecutive times
	Flame loss	Relight Attempts setting has been exceeded
	Flame detected upon transition into Ignition state	Any
Waiting	Any	Wait condition present
	Pilot Ignition failure	Pilot ignition has failed less than 3 times consecutively
	Flame loss	Relight Attempts settings has not been exceeded
Pilot	Successful pilot flame ignition	No alarm or wait conditions present, AND Minimum Pilots Running setting is satisfied

13.9 PILOT STATE

The controller transitions to the Pilot state (1) after successful pilot ignition, or (2) from a main fuel state upon high temperature or a main permissive condition. The Pilot state is a fuel state that holds the pilot valve outputs energized while holding the ignition outputs and main fuel valve outputs de-energized.



13.9.1 SAFETY OUTPUT BEHAVIOR - PILOT STATE

Card	Output	Output State
PF3101-00 BMS Controller card	Pilot	Energized
	SSV1	De-energized
	SSV2	De-energized
PF3102-00 Ion Pilot card	Valve	Energized
	Coil	De-energized ¹
PF3102-01 UV Pilot card	Ignition Enable	Open ¹

¹ Energized under reignition conditions in accordance with configured Pilot Relight Mode and Pilot Relight Timeout settings (Controller Settings > Outputs > Ignition).

13.9.2 TRANSITIONS TO THE PILOT STATE

From	Scenario	Condition
Ignition	Successful pilot flame ignition	No alarm or wait conditions present, AND Minimum Pilots Running setting is satisfied
Low Fire	Any	Main permissive condition present, AND Pilot Off Mode setting is set to Disabled or Off at Setpoint
	Process temperature is above its configured Low Fire setpoint	Pilot Off Mode setting is set to Disabled or Off at Setpoint
Process Control - High Fire	Any	Main permissive condition present, AND Pilot Off Mode setting is set to Disabled or Off at Setpoint
	Process temperature is above its configured Process setpoint	Low Fire Mode setting is set to Disabled , AND Pilot Off Mode is set to Disabled or Off at Setpoint
Process Control - Incinerate	Any	Main permissive condition present, AND Pilot Off Mode setting is set to Disabled or Off at Setpoint
Process Control - Incinerate No Assist	Any	Main permissive condition present, AND Pilot Off Mode setting is set to Disabled or Off at Setpoint
	Process temperature is above its configured Waste Gas Off setpoint	Pilot Off Mode setting is set to Disabled or Off at Setpoint
Process Control - PID Control	Any	Main permissive condition present, AND Pilot Off Mode setting is set to Disabled or Off at Setpoint
	Process temperature is above its configured Process setpoint and below its Low Fire setpoint	Low Heat Standby Mode setting is set to Main Permissive , AND Low Heat Standby Delay has elapsed
	Process temperature is above its configured Low Fire setpoint	Pilot Off Mode setting is set to Disabled or Off at Setpoint

13.9.3 TRANSITIONS FROM THE PILOT STATE

To	Scenario	Condition
Lockout	Any	Alarm condition present
	Controller stopped by user	Any
	Light Off Position has not been proven	HFV Output Mode setting is set to Forced Draft , AND Position Error Timeout setting has elapsed
	Flame loss	Relight Attempts setting has been exceeded
Waiting	Any	Wait condition present
	Flame loss	Relight Attempts setting limit has not been exceeded
Low Fire	Process temperature is below its configured Low Fire setpoint	Low Fire Mode setting is not set to Disabled , AND No main permissive conditions present, AND Incinerator Enable setting is set to Disabled
	Process temperature is below its configured Waste Gas On setpoint	No main permissive conditions present, AND Incinerator Enable setting is set to Enabled
Process Control - High Fire	Process temperature is below its configured Process setpoint	No main permissive conditions present, AND Low Fire Mode setting is set to Disabled

13.10 LOW FIRE STATE

The Low Fire state is a main fuel state that holds the system at its lowest stable firing rate. The safety output behavior is dependent on system behavior and is summarized below.



13.10.1 SAFETY OUTPUT BEHAVIOR – LOW FIRE STATE

Card	Output	Output State
PF3101-00 BMS Controller card	Pilot	Energized ¹
	SSV1	Energized
	SSV2	Energized ²
PF3102-00 Ion Pilot card	Valve	Energized ¹
	Coil	De-energized ³
PF3102-01 UV Pilot card	Ignition Enable	Open ³

¹ De-energized when Pilot Off Mode is set to Off After Main On

² De-energized when Incinerator Enable is set to Enabled

³ Energized under reignition conditions in accordance with configured Pilot Relight Mode and Pilot Relight Timeout settings (Controller Settings > Outputs > Ignition).

13.10.2 TRANSITIONS TO THE LOW FIRE STATE

From	Scenario	Condition
Pilot	Process temperature is below its configured Low Fire setpoint	Low Fire Mode setting is not set to Disabled , AND No main permissive conditions present, AND Incinerator Enable setting is set to Disabled
	Process temperature is below its configured Waste Gas On setpoint	No main permissive conditions present, AND Incinerator Enable setting is set to Enabled
Process Control – High Fire	Process temperature is above its configured Process setpoint	Any
Process Control – Incinerate	Process temperature is below its configured Waste Gas On setpoint	Any

13.10.3 TRANSITIONS FROM THE LOW FIRE STATE

To	Scenario	Condition
Lockout	Any	Alarm condition present
	Controller stopped by user	Any
	Flame loss	Relight Attempts setting has been exceeded
Waiting	Any	Wait condition present
	Any	Main permissive condition present, AND Pilot Off Mode setting is set to Off after Main On or Follow Main
	Flame loss	Relight Attempts setting has not been exceeded
	Process temperature is above its configured Low Fire setpoint	Pilot Off Mode setting is set to Off after Main On or Follow Main
Pilot	Any	Main permissive condition present, AND Pilot Off Mode setting is set to Disabled or Off at Setpoint
	Process temperature is above its configured Low Fire setpoint	Pilot Off Mode setting is set to Disabled or Off at Setpoint
Process Control - High Fire	Process temperature is below its configured Process setpoint	Low Fire Mode setting is not set to Disabled , AND No alarm or wait or main permissive conditions present
Process Control - Incinerate	Process temperature is above its configured Waste Gas On setpoint	Incinerator Enable setting is set to Enabled , AND No alarm or wait or main permissive conditions present
Process Control - PID Control	Process temperature is below its configured Process setpoint	4-20 Aux Out Mode setting is set to PID Control , AND No alarm or wait or main permissive conditions present

13.11 PROCESS CONTROL STATES

The controller transitions to a Process Control state when its heat demand is the highest. The Process Control state to which the controller transitions is dependent on the system configuration settings. The state transition conditions and safety output behavior for each Process Control state are detailed in the sections below.

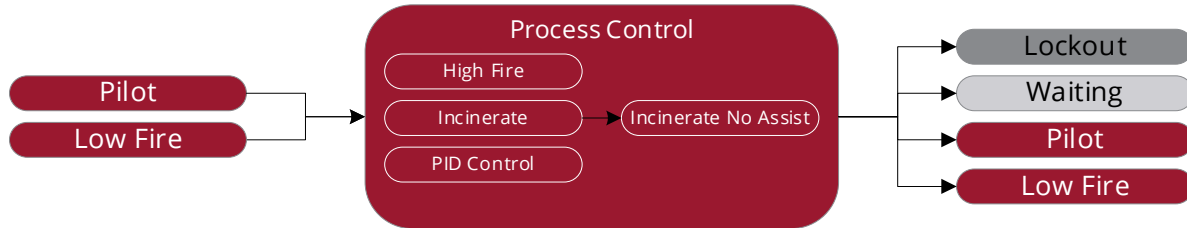

13.11.1 HIGH FIRE STATE

13.11.1.1 SAFETY OUTPUT BEHAVIOR – HIGH FIRE STATE

Card	Output	Output State
PF3101-00 BMS Controller card	Pilot	Energized ¹
	SSV1	Energized
	SSV2	Energized
PF3102-00 Ion Pilot card	Valve	Energized ¹
	Coil	De-energized ²
PF3102-01 UV Pilot card	Ignition Enable	Open ²

¹ De-energized when Pilot Off Mode is set to Off After Main On

² Energized under reignition conditions in accordance with configured Pilot Relight Mode and Pilot Relight Timeout settings (Controller Settings > Outputs > Ignition).

13.11.1.2 TRANSITIONS TO THE HIGH FIRE STATE

From	Scenario	Condition
Pilot	Process temp below configured Process setpoint	Low Fire Mode setting is Disabled , AND No alarm or wait or main permissive conditions present
Low Fire	Process temp below configured Process setpoint	No alarm or wait or main permissive conditions present

13.11.1.3 TRANSITIONS FROM THE HIGH FIRE STATE

To	Scenario	Condition
Lockout	Any	Alarm condition present
	Controller stopped by user	Any
	Flame loss	Relight Attempts setting exceeded
Waiting	Any	Wait condition present
	Any	Main permissive condition present, AND Pilot Off Mode setting is set to Off after Main On or Follow Main
	Flame loss	Relight attempts setting has not been exceeded
	Process temperature is above its configured Process setpoint	Low Fire Mode setting is set to Disabled , AND Pilot Off Mode setting is set to Off after Main On or Follow Main
Pilot	Any	Main permissive condition present, AND Pilot Off Mode setting is set to Disabled or Off at Setpoint
	Process temp above configured Process setpoint	Low Fire Mode setting is set to Disabled , AND Pilot Off Mode is set to Disabled or Off at Setpoint
Low Fire	Process temp above configured Process setpoint	Any

13.11.2 INCINERATE STATE

13.11.2.1 SAFETY OUTPUT BEHAVIOR - INCINERATE STATE

Card	Output	Output State
PF3101-00 BMS Controller card	Pilot	Energized ¹
	SSV1	Energized
	SSV2	Energized
PF3102-00 Ion Pilot card	Valve	Energized ¹
	Coil	De-energized ²
PF3102-01 UV Pilot card	Ignition Enable	Open ²

¹ De-energized when Pilot Off Mode is set to Off After Main On

² Energized under reignition conditions in accordance with configured Pilot Relight Mode and Pilot Relight Timeout settings (Controller Settings > Outputs > Ignition).

13.11.2.2 TRANSITIONS TO THE INCINERATE STATE

From	Scenario	Condition
Low Fire	Process temperature is above its configured Waste Gas On setpoint	Incinerator Enable setting is set to Enabled , AND No alarm or wait or main permissive conditions present
Incinerate No Assist	Process temperature is below its configured Assist Gas Off Setpoint	No alarm or wait or main permissive conditions present

13.11.2.3 TRANSITIONS FROM THE INCINERATE STATE

To	Scenario	Condition
Lockout	Any	Alarm condition present
	Controller stopped by user	Any
	Flame loss	Relight Attempts setting has been exceeded
Waiting	Any	Wait condition present
	Any	Main permissive condition present, AND Pilot Off Mode setting is set to Off after Main On or Follow Main
	Flame loss	Relight Attempts setting has not been exceeded
Pilot	Any	Main permissive condition present, AND Pilot Off Mode setting is set to Disabled or Off at Setpoint
Low Fire	Process temperature is below its configured Waste Gas On setpoint	Incinerator Enable setting is set to Enabled , AND No alarm or wait or main permissive conditions present
Incinerate No Assist	Process temperature is above its configured Assist Gas Off Setpoint	No alarm or wait or main permissive conditions present

13.11.3 INCINERATE NO ASSIST STATE

13.11.3.1 SAFETY OUTPUT BEHAVIOR – INCINERATE NO ASSIST STATE

Card	Output	Output State
PF3101-00 BMS Controller card	Pilot	Energized ¹
	SSV1	De-energized
	SSV2	Energized
PF3102-00 Ion Pilot card	Valve	Energized ¹
	Coil	De-energized ²
PF3102-01 UV Pilot card	Ignition Enable	Open ²

¹ De-energized when Pilot Off Mode is set to Off After Main On

² Energized under reignition conditions in accordance with configured Pilot Relight Mode and Pilot Relight Timeout settings (Controller Settings > Outputs > Ignition).

13.11.3.2 TRANSITIONS TO THE INCINERATE NO ASSIST STATE

From	Scenario	Condition
Incinerate	Process temperature is above its configured Assist Gas Off Setpoint	No alarm or wait or main permissive conditions present

13.11.3.3 TRANSITIONS FROM THE INCINERATE NO ASSIST STATE

To	Scenario	Condition
Lockout	Any	Alarm condition present
	Controller stopped by user	Any
	Flame loss	Relight Attempts setting exceeded
Waiting	Any	Wait condition present
	Any	Main permissive condition present, AND Pilot Off Mode setting is set to Off after Main On or Follow Main
	Flame loss	Relight Attempts setting has not been exceeded
	Process temperature is above its configured Waste Gas Off setpoint	Pilot Off Mode setting is set to Off after Main On or Follow Main
Pilot	Any	Main permissive condition present, AND Pilot Off Mode setting is set to Disabled or Off at Setpoint
	Process temperature is above its configured Waste Gas Off setpoint	Pilot Off Mode setting is set to Disabled or Off at Setpoint
Incinerate	Process temperature is below its configured Assist Gas Off Setpoint	No alarm or wait or main permissive conditions present

13.11.4 PID CONTROL STATE

13.11.4.1 SAFETY OUTPUT BEHAVIOR – PID CONTROL STATE

Card	Output	Output State
PF3101-00 BMS Controller card	Pilot	Energized ¹
	SSV1	Energized
	SSV2	Energized
PF3102-00 Ion Pilot card	Valve	Energized ¹
	Coil	De-energized ²
PF3102-01 UV Pilot card	Ignition Enable	Open ²

¹ De-energized when Pilot Off Mode is set to Off After Main On

² Energized under reignition conditions in accordance with configured Pilot Relight Mode and Pilot Relight Timeout settings (Controller Settings > Outputs > Ignition).

13.11.4.2 TRANSITIONS TO THE PID CONTROL STATE

From	Scenario	Condition
Low Fire	Process temperature is below its configured Process setpoint	4-20 Aux Out Mode setting is set to PID Control , AND No alarm or wait or main permissive conditions present

13.11.4.3 TRANSITIONS FROM THE PID CONTROL STATE

To	Scenario	Condition
Lockout	Any	Alarm condition present
	Controller stopped by user	Any
	Flame loss	Relight Attempts setting has been exceeded
Waiting	Any	Wait condition present
	Any	Main permissive condition present, AND Pilot Off Mode setting is set to Off after Main On or Follow Main
	Flame loss	Relight Attempts setting has not been exceeded
	Process temperature is above its configured Process setpoint and below its Low Fire setpoint	Low Heat Standby Mode setting is set to Wait , AND Low Heat Standby Delay has elapsed
	Process temperature is above its configured Low Fire setpoint	Pilot Off Mode is set to Off after Main On or Follow Main
Pilot	Any	Main permissive condition present, AND Pilot Off Mode setting is set to Disabled or Off at Setpoint
	Process temperature is above its configured Process setpoint and below its Low Fire setpoint	Low Heat Standby Mode setting is set to Main Permissive , AND Low Heat Standby Delay has elapsed
	Process temperature is above its configured Low Fire setpoint	Pilot Off Mode setting is set to Disabled or Off at Setpoint

14 INSTALLATION



Warning: Installation and modification shall not be performed while the system is energized. Disconnect power source prior to connecting devices or modifying wiring.

Installers and commissioners of the PF3100 system must:

- Understand local codes and how they apply to the installation (for both electrical and mechanical aspects of the installation),
- Understand the electrical and mechanical limitations of the product,
- Understand the safety and operational effects of modifying system settings or wiring,
- Verify all required safety functions prior to completing the commissioning of the appliance,
- Be fluent in the English language (the only language this product supports),
- Be familiar with navigating the product menus and modifying settings.

14.1 MOUNTING CONSIDERATIONS

The UX, CTX and AUX enclosures should be mounted:

- Upright in such a way that the screen/status indicators are clearly visible (if applicable),
- Near to the appliance/burner/component being controlled to minimize cable run lengths while maintaining hazardous location requirements,
- Such that the enclosure door can be fully opened during maintenance and commissioning,
- Such that the screen and keypad are protected from direct sunlight exposure.

The EPX and TLX enclosures should be mounted:

- Close to the burner/temperature element under control to limit cable run lengths,
- In an orientation that maintains accessibility during maintenance and commissioning.

14.1.1 HAZARDOUS LOCATION MOUNTING



Warning: EXPLOSION HAZARD – Substitution of components may impair suitability for hazardous locations.



Warning: Do not drill holes in, or otherwise modify, any enclosures as any such modifications will compromise hazardous location suitability.



Warning: Appropriately zoned wiring methods must be used between modules to maintain hazardous location ratings.

14.1.1.1 EPX ENCLOSURE MOUNTING

To maintain the hazardous location rating for the EPX enclosure, all the following conditions must be met:

- The enclosure lid must be tightened down until it is flush with the base and the locking screw must be fully secured,
- Each unused conduit entry port must be sealed with appropriately rated pipe plugs,
- Any conduit entry ports in use must be sealed in accordance with local electrical code(s),
- All fittings must have at least 5 full threads of engagement,
- All fittings must be ¾" NPT.

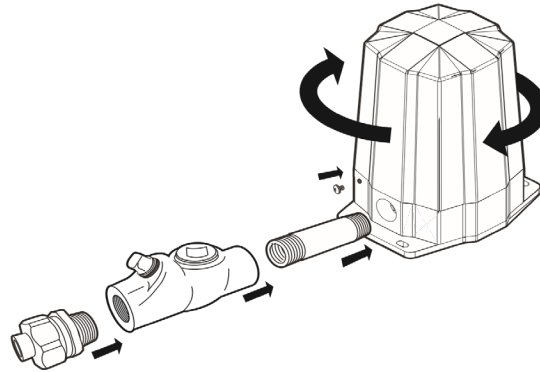

14.1.1.2 TLX ENCLOSURE MOUNTING

To maintain the hazardous location rating for the TLX enclosure, all the following conditions must be met:

- The enclosure lid must be fully tightened down,
- Any conduit entry ports in use must be sealed in accordance with local electrical code(s),
- Each unused conduit entry port must be sealed with appropriately sized and rated pipe plugs,
- Thermocouple probe must be installed in an appropriately rated thermowell.

14.2 HARDWARE INSTALLATION DIAGRAMS

14.2.1 ION PILOT MODULE

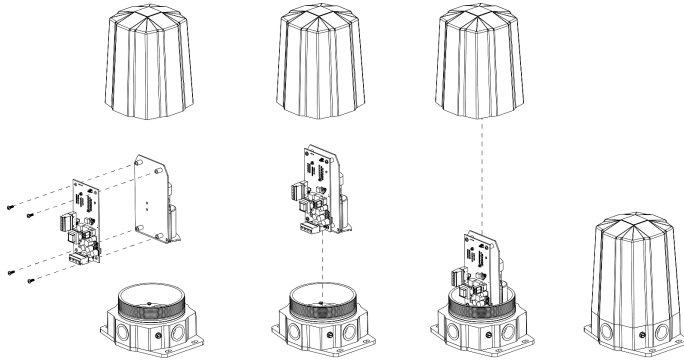

Installation Notes:

1. Install four #10-32 screws through the Ion Pilot card to attach it to the coil bracket.
2. Tighten to 26 in•lbs
3. Loosen two adjacent #6-32 screws from bottom inside of enclosure, then line up bracket and tighten down the screws
4. Install enclosure lid making sure it is fully seated.
5. Tighten #10-32 enclosure lock screw.

14.2.2 TEMPERATURE MODULE



Installation Notes:

1. Install two #10-32 screws through the Temperature card into the enclosure standoffs.
2. Tighten to 26 in•lbs
3. Install enclosure lid making sure it is fully seated.

14.2.3 REPLACEMENT CARDS

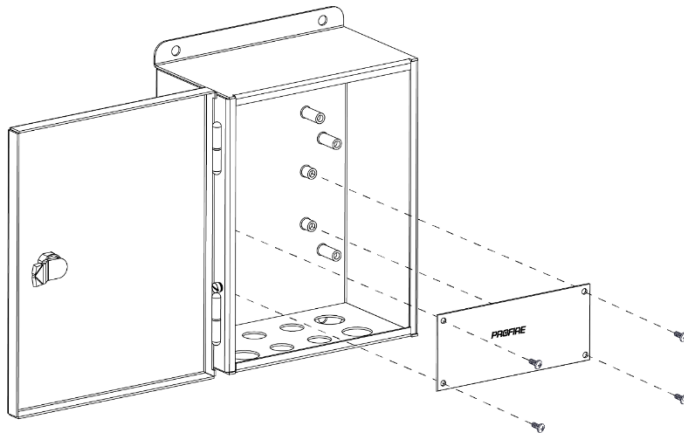

Installation Notes:

1. Install four #10-32 screws through the card into the enclosure standoffs.
2. Tighten to 26 in•lbs
3. Close enclosure door and secure lock with a flat head screwdriver.

14.3 CONNECTION DIAGRAMS



Caution: Electrical devices connected to the controller must meet local electrical codes and be within the voltage limits specified in this manual.



Caution: All field wiring must be properly fused and sized in accordance with local codes.



Caution: Wires must be installed such that the connection does not rely on the structural integrity of the wire insulation and no more than one conductor is terminated in a single terminal.

14.3.1 POWER INPUT WIRING

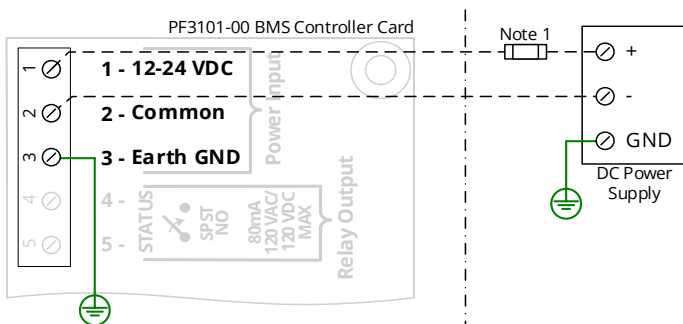

Installation Notes:

1. The power supply must be fused in accordance with local electrical codes.
2. Power input wiring is shown for the BMS Controller card as an example only. The power input to the Modbus, Network and Pilot Spark cards can be wired in the same way.

14.3.2 DIGITAL INPUT - DRY CONTACT

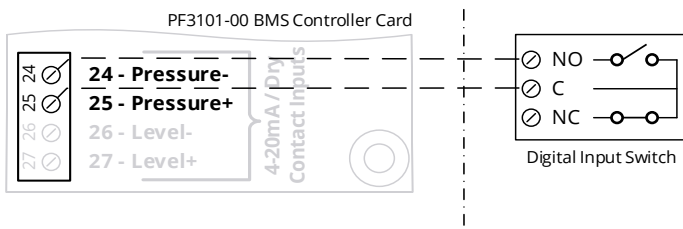

Installation Notes:

1. Pressure input wiring shown as an example only. Device can be wired to other digital inputs in the same way. For I/O Expansion inputs, the PWR Out terminal corresponds to the "+" terminal in the diagram and the Signal In terminal corresponds to the "-" terminal in the diagram.
2. The PF3100 system uses energized-to-run logic for all digital inputs. Wire to NO or NC contacts accordingly.
3. BMS: + terminal output matches system voltage input.
I/O Expansion - 12V Mode: PWR output is 14V
I/O Expansion - 24V Mode: PWR output is 24V
Ion Pilot Aux In - + terminal output is 12V

14.3.3 DIGITAL INPUT - WET CONTACT

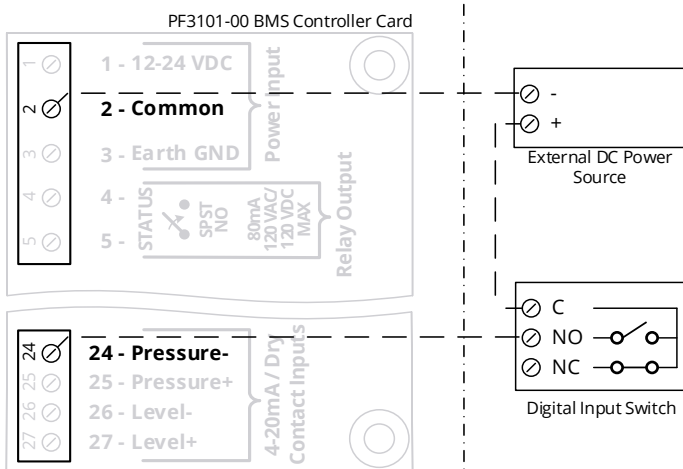

Installation Notes:

1. Pressure input wiring shown as an example only. Device can be wired to other digital inputs in the same way. For I/O Expansion inputs, the PWR Out terminal corresponds to the "+" terminal in the diagram and the Signal In terminal corresponds to the "-" terminal in the diagram.
2. The PF3100 system uses energized-to-run logic for all digital inputs. Wire to NO or NC contacts accordingly.
3. External power source must be Earth grounded.
4. External power source must not (1) exceed 30V_{DC}, or (2) drop below -0.5V with reference to BMS Controller card Common terminal (terminal 2).

14.3.4 ANALOG INPUT - LOOP POWERED 4-20mA TRANSMITTER

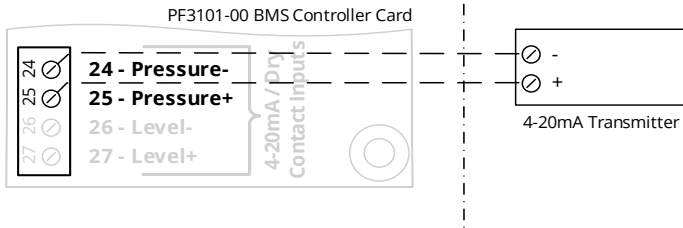

Installation Notes:

1. Pressure input wiring shown as an example only. Device can be wired to other analog inputs in the same way. For I/O Expansion inputs, the PWR Out terminal corresponds to the "+" terminal in the diagram and the Signal In terminal corresponds to the "-" terminal in the diagram.
2. BMS: + terminal output matches system voltage input.
I/O Expansion - 12V Mode: PWR output is 14V
I/O Expansion - 24V Mode: PWR output is 24V
Ion Pilot Aux In - + terminal output is 12V

14.3.5 ANALOG INPUT - SELF POWERED 4-20mA TRANSMITTER

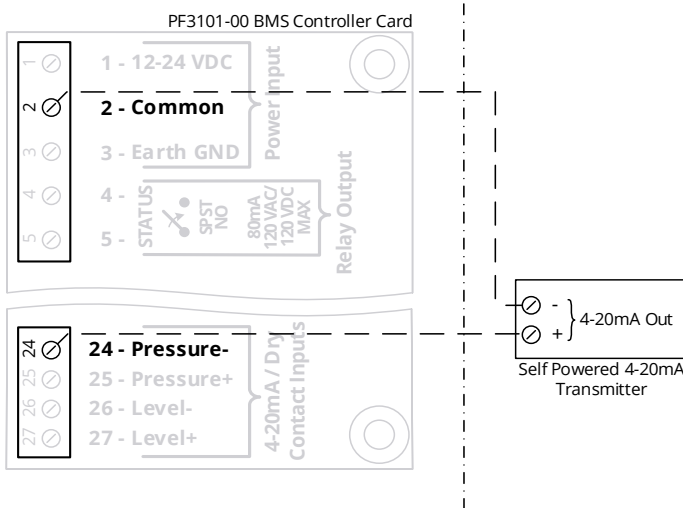

Installation Notes:

1. Pressure input wiring shown as an example only. Device can be wired to other analog inputs in the same way. For I/O Expansion inputs, the PWR Out terminal corresponds to the "+" terminal in the diagram and the Signal In terminal corresponds to the "-" terminal in the diagram.
2. Field device must be Earth grounded.
3. Transmitter signal output must be referenced about BMS Controller card Common terminal (terminal 2).

14.3.6 ANALOG INPUT - INPUT FROM PLC

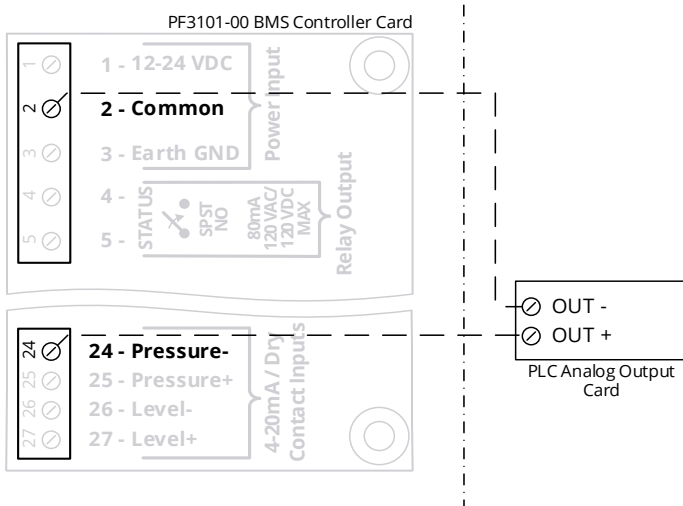

Installation Notes:

1. Pressure input wiring shown as an example only. Device can be wired to other analog inputs in the same way. For I/O Expansion inputs, the PWR Out terminal corresponds to the "+" terminal in the diagram and the Signal In terminal corresponds to the "-" terminal in the diagram.
2. PLC output signal must be referenced about BMS Controller card Common terminal (terminal 2).

14.3.7 PROPORTIONAL VALVE OR ACTUATOR WIRING

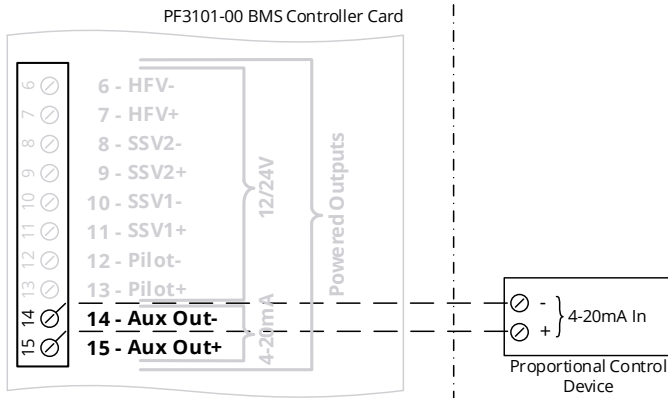

Installation Notes:

1. BMS Aux Out wiring shown as an example only. The same wiring method can be used to connect to the I/O Expansion 4-20mA Output, where the GND Return terminal corresponds to the “-” terminal in the diagram and the Signal Out terminal corresponds to the “+” terminal in the diagram.

14.3.8 ANALOG OUTPUT – 4-20mA ECHO TO PLC

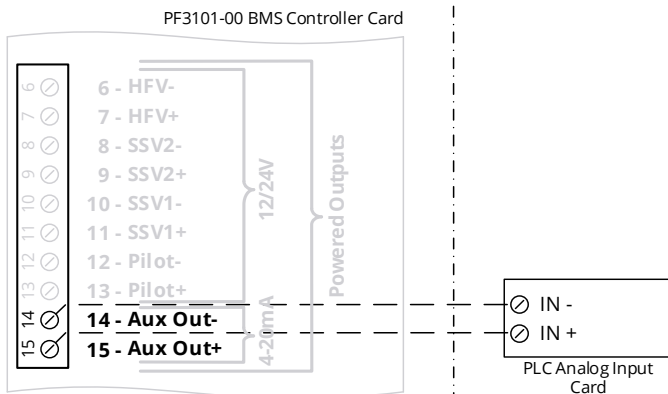

Installation Notes:

1. BMS Aux Out wiring shown as an example only. The same wiring method can be used to connect to the I/O Expansion 4-20mA Output, where the GND Return terminal corresponds to the “-” terminal in the diagram and the Signal Out terminal corresponds to the “+” terminal in the diagram.

14.3.9 SOLENOID OUTPUT – 12V/24V

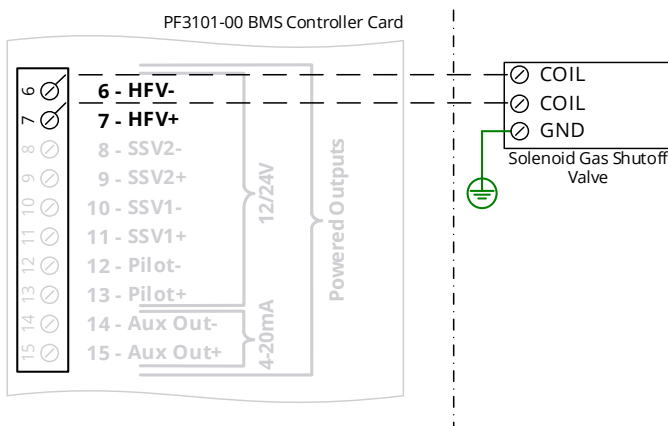

Installation Notes:

1. HFV output wiring shown as an example only. Solenoids can be wired to the other valve outputs in the same way.
2. Solenoid powered outputs are rated to 5A max individually, however the power input to the BMS is fused at 10A. Care must be taken as to not exceed the 10A max input when using multiple high-powered solenoids.
3. Solenoid valve outputs are assumed to be in safe state when de-energized. Normally closed valves must be used such that gas-flow to the burner is stopped when the output is in the de-energized state. Solenoid valve outputs can also be connected to normally open bleed valves when utilizing a double block and bleed configuration.



Caution: Do not connect solenoid device minus (-) terminals to ground, as the BMS solenoid output minus (-) terminals are not grounded.



Caution: Do not jumper solenoid minus terminals together under any circumstance, as this will compromise the safety integrity of the system.

14.3.10 HFV OUTPUT - FAN CONTROL WIRING

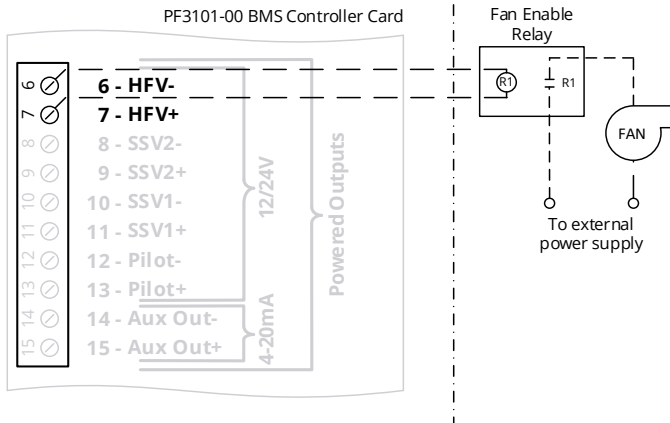

Installation Notes:

1. A relay must be used to isolate the HFV contacts from high-transient currents from the fan motor.

14.3.11 RUN STATUS – AC SOURCE

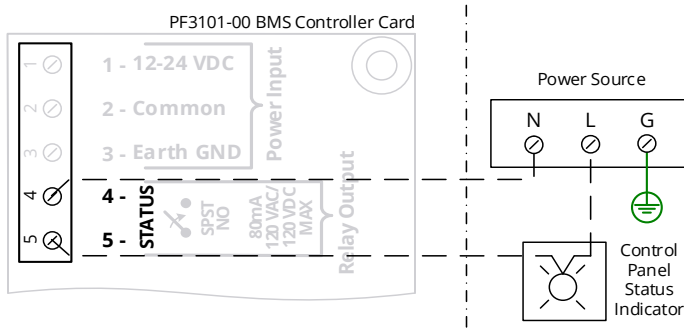

Installation Notes:

1. BMS Controller card Status contact wiring shown as an example only. The I/O Expansion card status contacts can be wired in the same way.



Warning: 120VAC wiring should be installed by a qualified electrician.

14.3.12 RUN STATUS – DC SOURCE

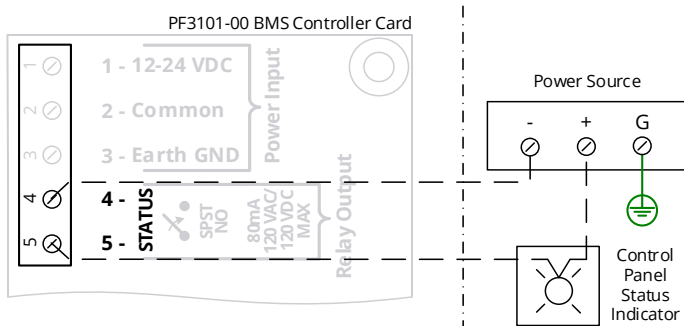

Installation Notes:

1. BMS Controller card Status contact wiring shown as an example only. The I/O Expansion card status contacts can be wired in the same way.

14.3.13 RUN STATUS – PUMP CONTROL

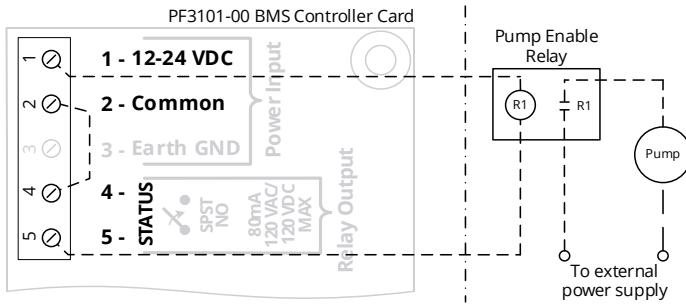

Installation Notes:

1. A relay must be used to isolate the Run Status contacts from high-transient currents associated with motors and pumps.

14.3.14 SINGLE ROD IGNITION WIRING

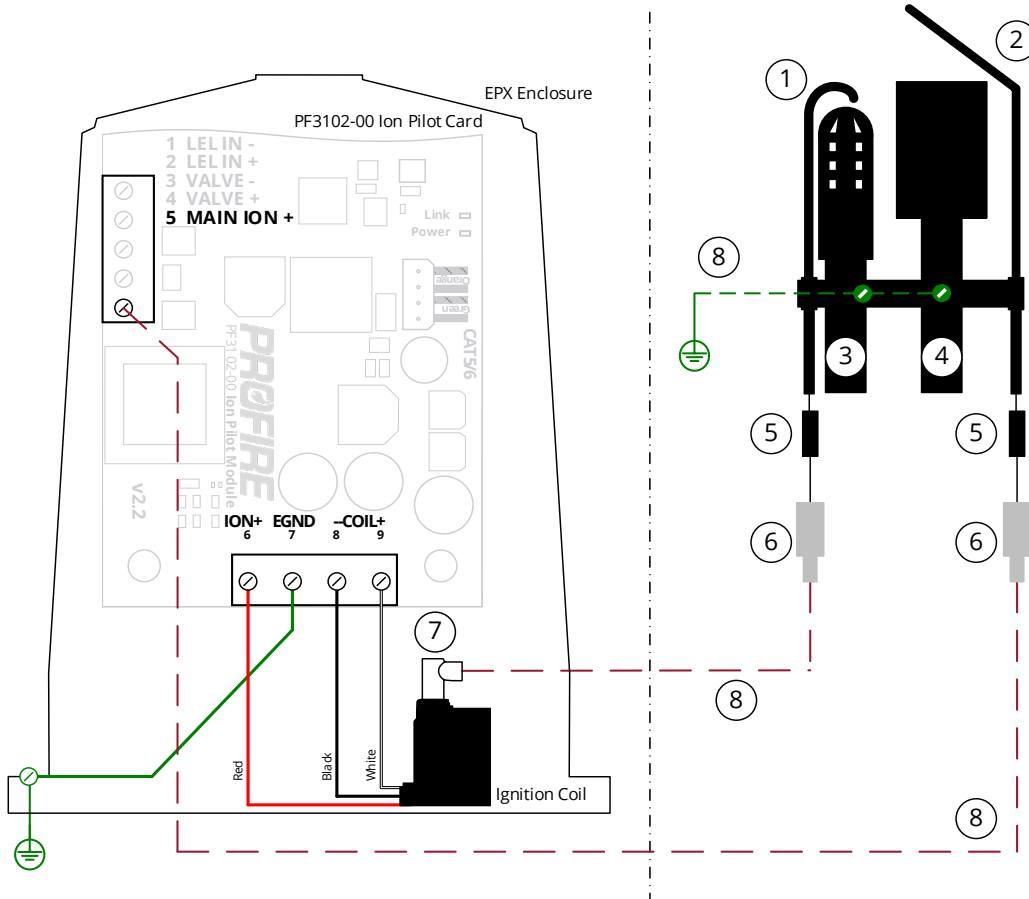

Legend:

#	Description
1	Pilot ignition/ flame detection rod
2	Main flame detection rod
3	Pilot nozzle
4	Main burner
5	Ferrule
6	Straight silicone boot
7	90° spark plug connector
8	7mm ignition wire

Installation Notes:

1. The wire length between the ignition coil and pilot should be no more than 3m (10ft).
2. Connect burner housing to EGND terminal with ignition wire to avoid ground-loading.
3. Optimal spark gap distance between pilot nozzle and ignition rod is 6mm (0.25").



Warning: Failure to provide a low-impedance path from the burner assembly to the PF3100 may result in electric shock, product damage, failure to ignite the pilot, or failure to detect flame.



Warning: Flame rods are not intended to be mounted in Class I, Division 1 or 2 hazardous locations. Flame rod installation shall be in accordance with local electrical codes.

14.3.15 DUAL ROD IGNITION WIRING

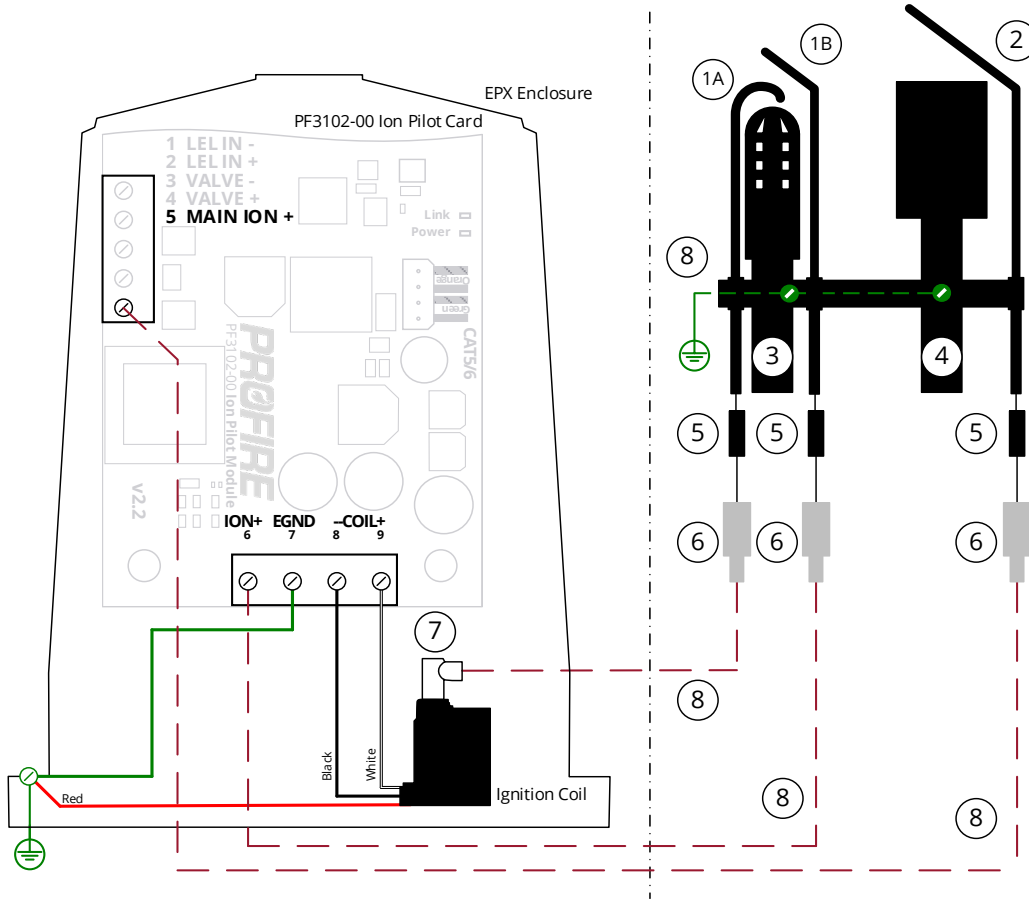

Legend:

#	Description
1A	Pilot ignition rod
1B	Pilot flame detection rod
2	Main flame detection rod
3	Pilot nozzle
4	Main burner
5	Ferrule
6	Straight silicone boot
7	90° spark plug connector
8	7mm ignition wire

Installation Notes:

1. The wire length between the ignition coil and pilot should be no more than 3m (10ft).
2. Connect burner housing to EGND terminal with ignition wire to avoid ground-loading.
3. Optimal spark gap distance between pilot nozzle and ignition rod is 6mm (0.25").



Warning: Failure to provide a low-impedance path from the burner assembly to the PF3100 may result in electric shock, product damage, failure to ignite the pilot, or failure to detect flame.



Warning: Flame rods are not intended to be mounted in Class I, Division 1 or 2 hazardous locations. Flame rod installation shall be in accordance with local electrical codes.

14.3.16 ION PILOT HIGH ENERGY IGNITION MODULE WIRING

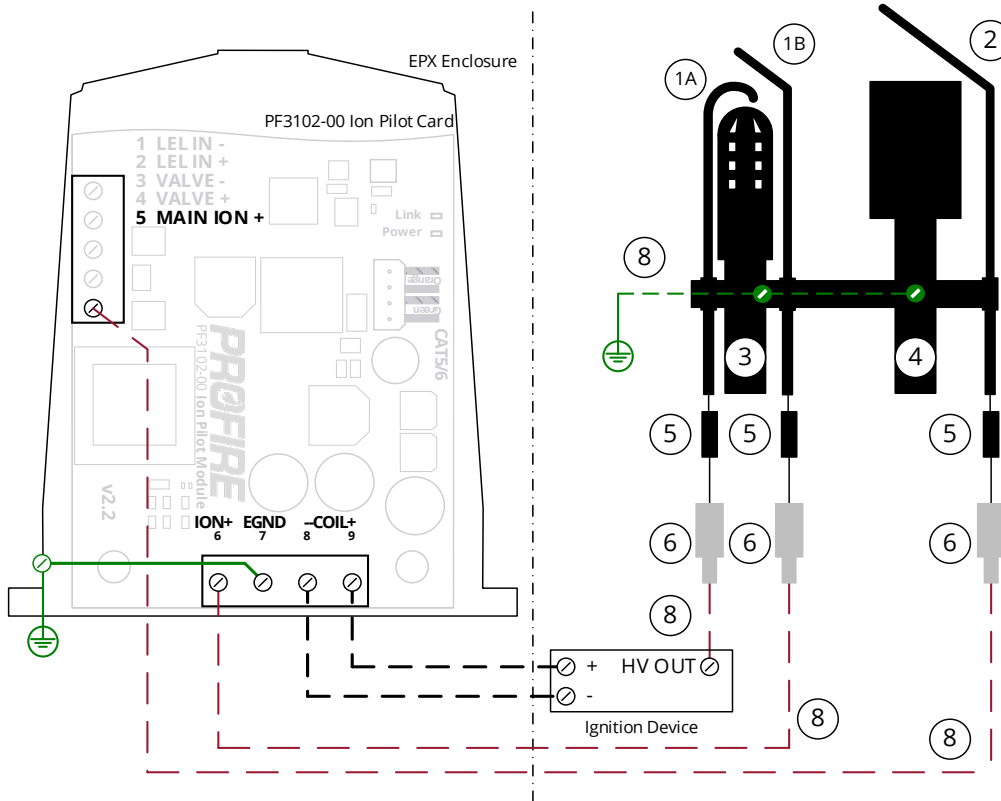

Legend:

#	Description
1A	Pilot ignition rod
1B	Pilot flame detection rod
2	Main flame detection rod
3	Pilot nozzle
4	Main burner
5	Ferrule
6	Straight silicone boot
7	90° spark plug connector
8	7mm ignition wire

Installation Notes:

1. The wire length between the ignition coil and pilot should be no more than 3m (10ft).
2. Connect burner housing to EGND terminal with ignition wire to avoid ground-loading.
3. Optimal spark gap distance between pilot nozzle and ignition rod is 6mm (0.25").



Warning: Failure to provide a low-impedance path from the burner assembly to the PF3100 may result in electric shock, product damage, failure to ignite the pilot, or failure to detect flame.



Warning: Flame rods are not intended to be mounted in Class I, Division 1 or 2 hazardous locations. Flame rod installation shall be in accordance with local electrical codes.

14.3.17 UV PILOT TO SPARK CARD WIRING

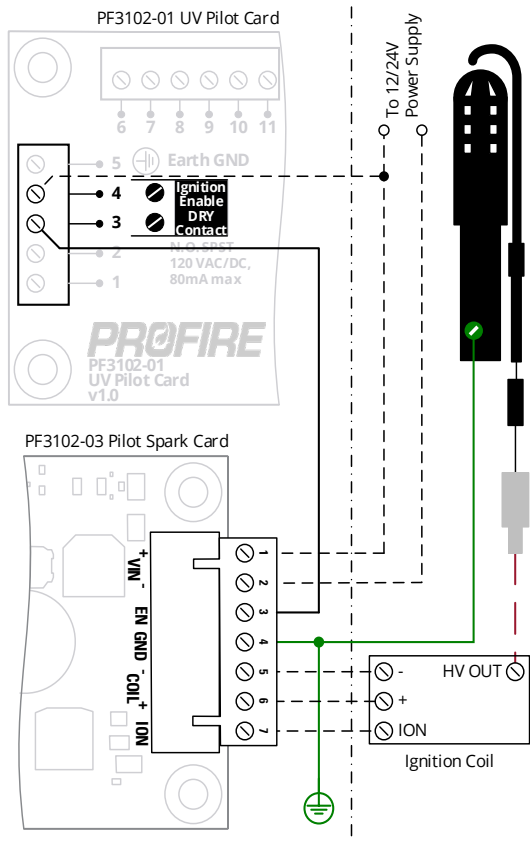

14.3.18 UV PILOT HIGH ENERGY IGNITION MODULE WIRING

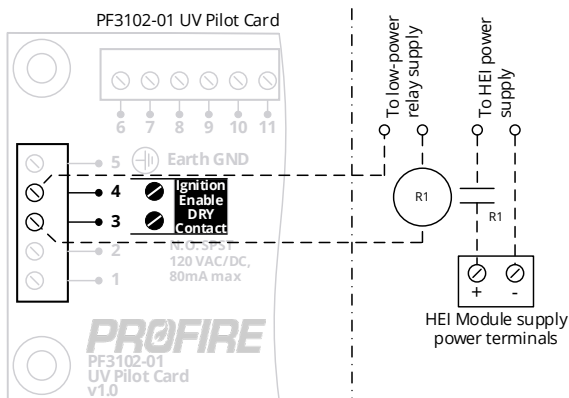

Installation Notes:

1. A fault tolerant safety relay must be used for this application

14.3.19 UV FLAME SCANNER WIRING

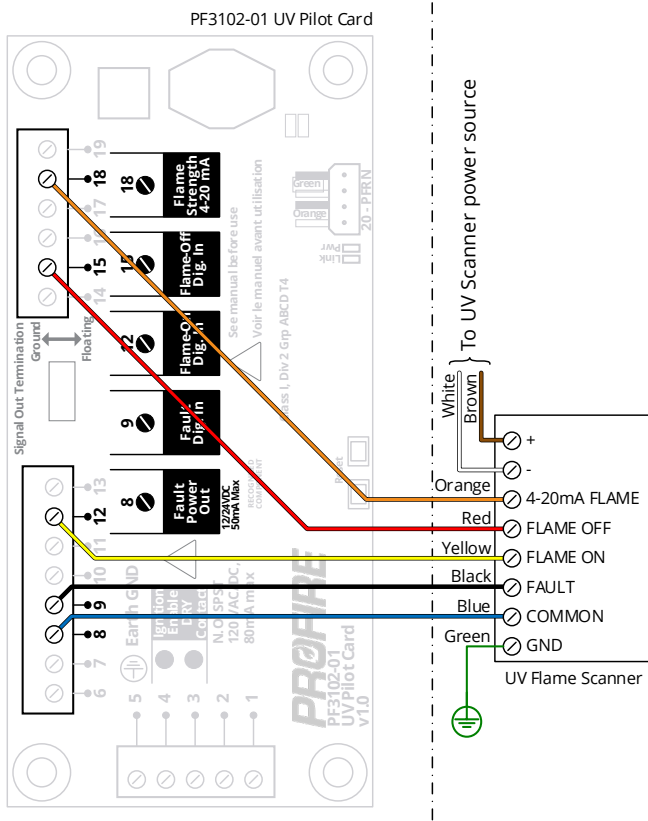

Installation Notes:

1. Wire colors shown are applicable for Fireye 65UV5-1004E UV Flame Scanner only.

14.3.20 DUAL-ELEMENT THERMOCOUPLE WIRING

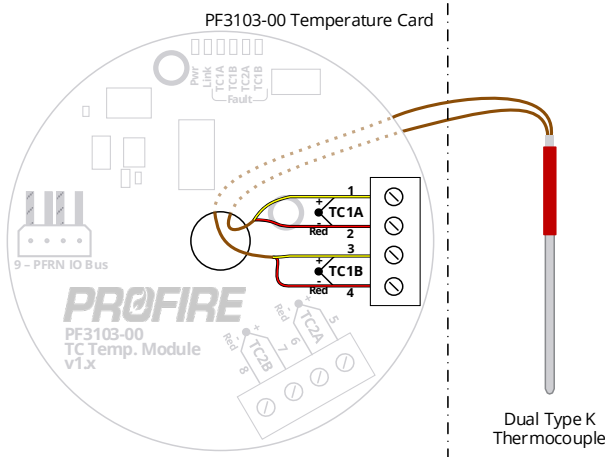

Installation Notes:

1. TC1 input wiring shown as an example only. Thermocouple can also be wired to TC2 in the same way.
2. Thermocouple must be ungrounded Type K.
3. Thermocouple wire run lengths should be minimized where possible.
4. Thermocouple wires should not be run in the same conduit as high-noise signals (e.g., valve wires, motor wires, etc.)

14.3.21 SINGLE-ELEMENT THERMOCOUPLE WIRING

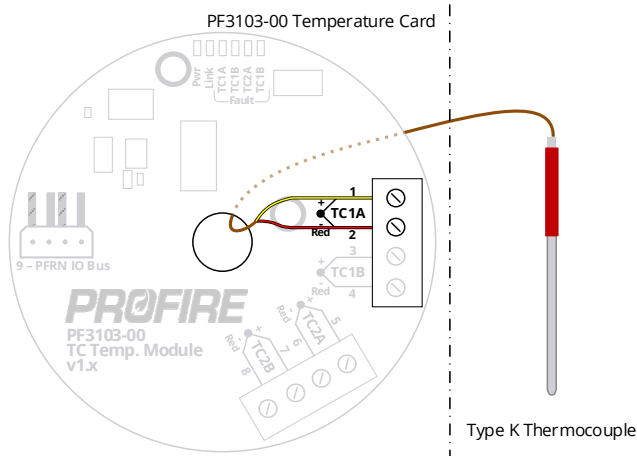

Installation Notes:

1. TC1A input wiring shown as an example only. Thermocouple can be wired to TC1B, TC2A and TC2B in the same way.
2. Thermocouple must be ungrounded Type K.
3. Thermocouple wire run lengths should be minimized where possible.
4. Thermocouple wires should not be run in the same conduit as high-noise signals (e.g., valve wires, motor wires, etc.)

14.3.22 THERMOCOUPLE FLAME DETECTION

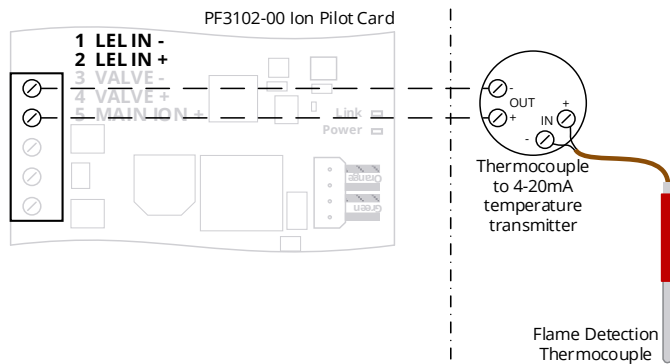

14.3.23 MODBUS INPUT WIRING

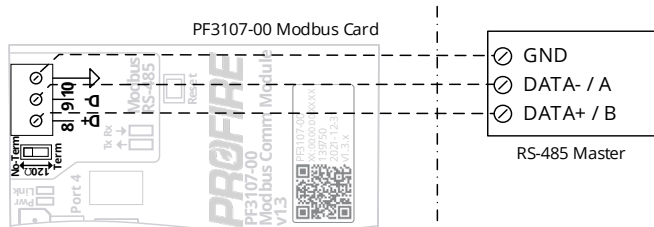

Installation Notes:

1. Modbus wires should not be run in the same conduit as high-noise signals (e.g., valve wires, motor wires, etc.)
2. Move Dip switch to the "Term" position to activate the termination resistor. Termination is recommended if the Modbus card is on the end of the Modbus chain

14.3.24 SINGLE TRANSMITTER TO MULTIPLE I/O EXPANSION INPUTS

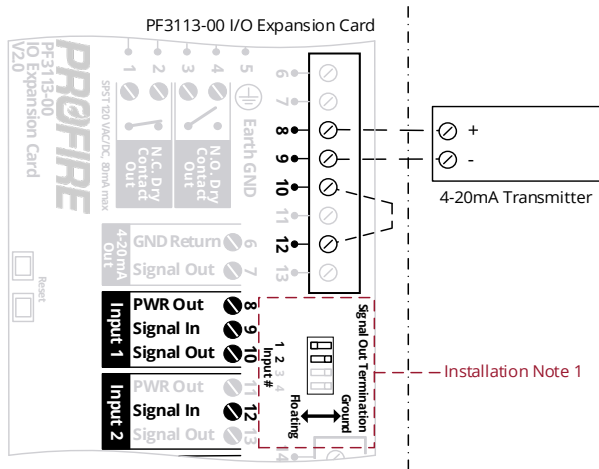

Installation Notes:

1. Set DIP switch to the "Floating" position for any input that is echoed out from its Signal Out terminal to another input and set the rest of the DIP switched to the "Ground" position.
2. The Voltage at terminal 8 (PWR Out) corresponds to the configured voltage output setting for the I/O Expansion Card (I/O Wizard > I/O Modules Tab > Module Voltage.)
3. Input 1 and 2 wiring is shown as an example only. The wiring concepts apply to any combination of the 4 I/O Expansion inputs.
4. Wiring for a loop powered transmitter is shown as an example only. Self powered transmitters can also be used - In this case, terminal 8 (PWR Out) is to be left unused.



Warning: I/O Expansion card inputs connected to the Signal Out terminal of another I/O Expansion card input are not safety rated.

14.3.25 8P8C PFRN CONNECTOR WIRING

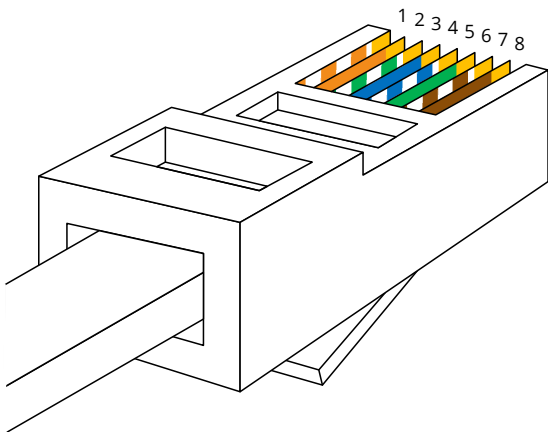

Wire Colors per T568B wiring standard:

Wire	Color
1	Orange & White
2	Orange
3	Green & White
4	Blue *
5	Blue & White *
6	Green
7	Brown & White *
8	Brown *

* Not required

Installation Notes:

1. Solid core Cat5e or higher rated Ethernet cable should be used for all PFRN connections.
2. PFRN cable runs must not exceed 250m (820 ft).

14.3.26 PF3100 PFRN CONNECTOR WIRING

Connector Style 1

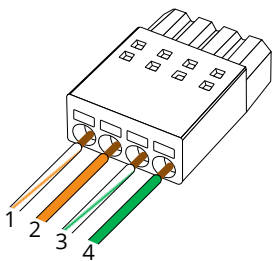

Connector Style 2

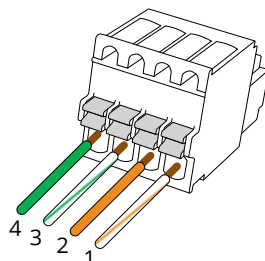

Wire Colors for PF3100 PFRN connector:

Wire	Color
1	Orange & White
2	Orange
3	Green & White
4	Green

Installation Notes:

1. Solid core Cat5e or higher rated Ethernet cable should be used for all PFRN connections.
2. PFRN cable runs must not exceed 250m (820 ft).

14.3.27 UI PFRN CONNECTION OPTIONS

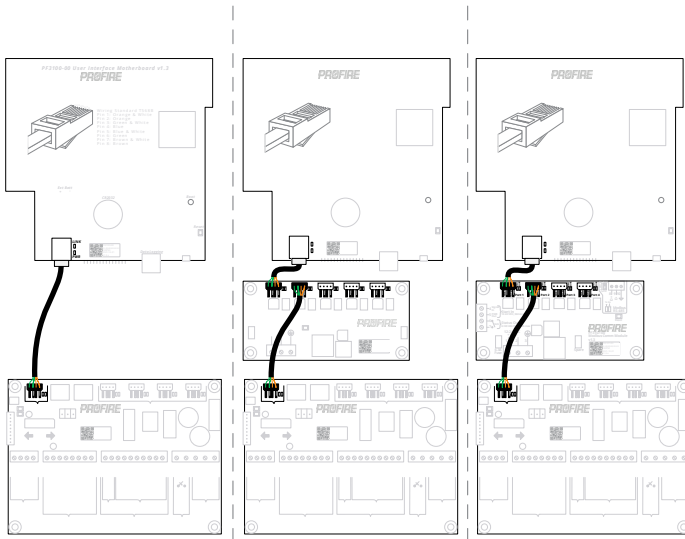

- Option 1: Direct connection from UI card to BMS Controller card.
- Option 2: Connection from UI card to BMS controller card via Network card.
- Option 3: Connection from UI card to BMS Controller card via Modbus card.
- Option 4: (Not shown) Connection from UI card to BMS Controller card via Modbus card and Network card.

Installation Notes:

1. Solid core Cat5e or higher rated Ethernet cable should be used for all PFRN connections.
2. PFRN cable runs must not exceed 250m (820 ft).
3. UI PFRN connections must not connect to BMS PFRN IO Network terminals 29, 30, 31 or 32.

14.3.28 I/O CARD PFRN WIRING OPTIONS

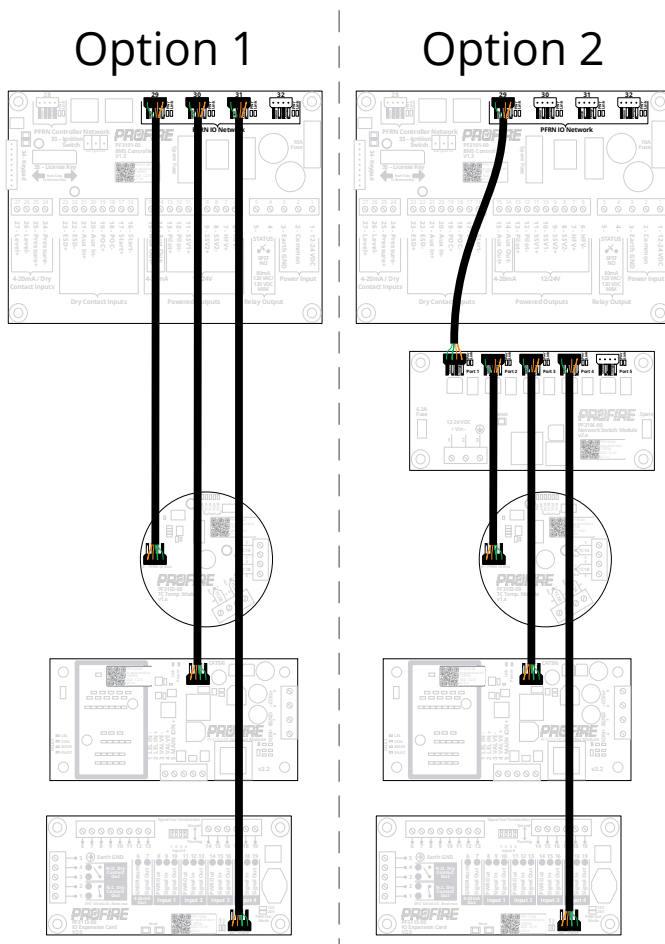

- Option 1: Direct connection from I/O cards to BMS Controller card.
- Option 2: Connection from I/O cards to BMS controller card via Network card.

I/O Cards:

- PF3102-00 Ion Pilot Card
- PF3102-01 UV Pilot Card
- PF3103-00 Temperature Card
- PF3113-00 I/O Expansion Card

Installation Notes:

1. Solid core Cat5e or higher rated Ethernet cable should be used for all PFRN connections.
2. PFRN cable runs must not exceed 250m (820 ft).
3. I/O card PFRN connections must not connect to BMS PFRN Controller Network terminal 28.

14.3.29 COMBINED LOW/HIGH PRESSURE SWITCH WIRING

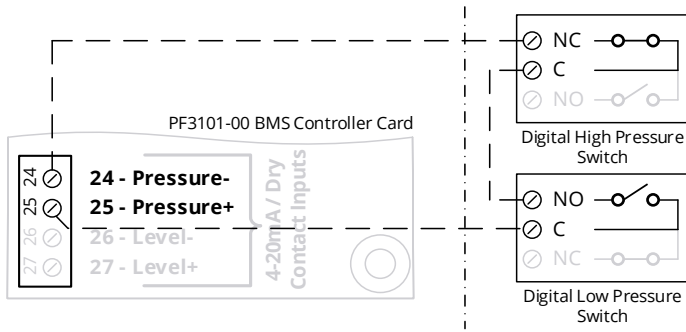

Installation Notes:

1. The PF3100 system uses energized-to-run logic for all digital inputs. Wire to NO contact of the low-pressure switch and NC contact of the high-pressure system.
2. + terminal output matches system voltage input.

15 SYSTEM CONFIGURATION

The PF3100 system is designed to be modular and scalable to accommodate a variety of different heating applications. The section below outlines key concepts and terminology that are useful to understand when designing a PF3100 system.

15.1 APPLIANCE

An Appliance is made up of one or more BMS controller cards working together and represents the actual heating appliance that exists on site. Each appliance on site must be represented as a separate appliance on the PF3100. A single UI card can control multiple appliances, but information cannot be shared between them.

15.2 BMS CONTROLLER

Each burner in an appliance must have its own BMS controller card. The controller cards connect to pilot cards, temperature cards, expansion cards and burner or appliance instrumentation. A BMS controller card can share information with other controllers connected to the same appliance only.

15.3 I/O CARD

15.3.1 PILOT CARD

Pilot cards connect to each BMS controller card and are responsible for the ignition and flame detection of individual pilot burners.

15.3.2 TEMPERATURE CARD

Temperature cards connect to BMS controller cards and are responsible for monitoring various appliance temperatures using Type K thermocouples.

15.3.3 I/O EXPANSION CARD

I/O Expansion cards can be connected to BMS controller cards in an appliance to give the system enhanced input and output capabilities.

15.4 MODBUS CARD

Modbus cards must be connected (if required) into a PFRN Controller Network port between the UI and BMS controller card(s) to enable the system to communicate via Modbus.

15.5 NETWORK CARD

Network cards can be connected (1) to a PFRN Controller Network port between the UI and BMS controller card(s) to allow additional BMS controller cards to be connected to the system, or (2) into a PFRN I/O Network port to allow additional I/O cards to be connected to a BMS controller.

15.6 COMMUNICATION

The PF3100 system uses a proprietary communication protocol called PFRN. This is a robust safety network based on Ethernet protocols which allows for easy installation and expansion. The PFRN network also distributes DC power to the I/O cards.

15.7 CARD IDENTIFICATION

Each card has a label providing important hardware information. The serial number doubles as a MAC address for communication and is referenced on-screen to distinguish between cards.

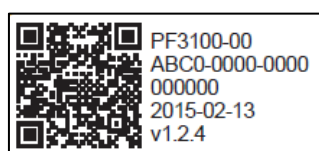

Line 1: Card Hardware Model Number
Line 2: Card Serial Number/MAC Address
Line 3: Lot Code
Line 4: Hardware Build Date
Line 5: Hardware Version

15.8 SYSTEM SCALING

At a minimum, each PF3100 system is comprised of one BMS controller card, one ion pilot card and one temperature card for each appliance under control. Only one User Interface card is required to control all the appliances in a system. BMS controller cards, pilot cards, temperature cards and I/O Expansion cards can be added as required to accommodate larger or more complex appliances in accordance with the diagram below:

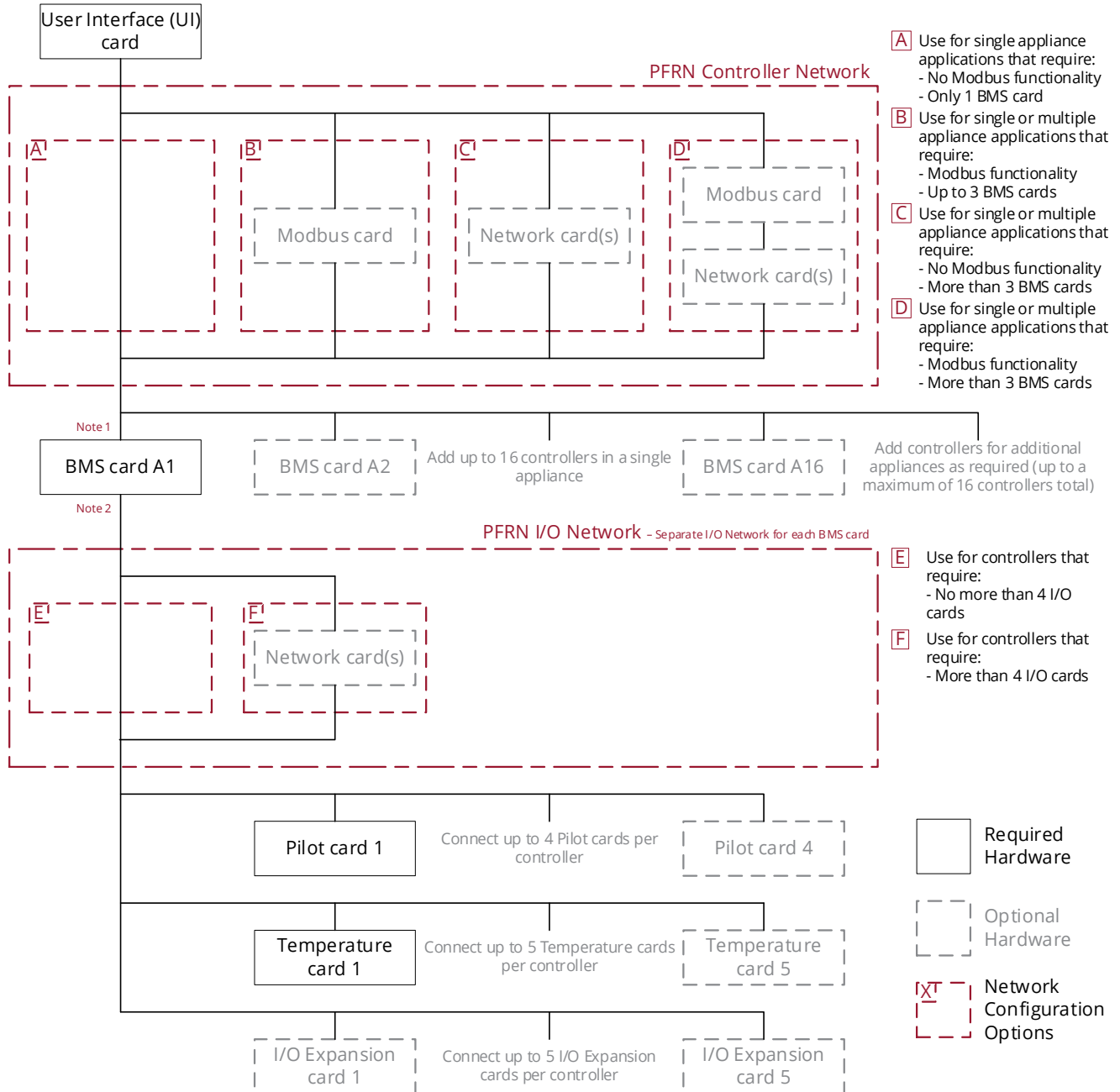

¹ PFRN Controller Network connections must only connect to port 28 of the BMS cards.

² PFRN I/O Network connections must only connect to ports 29, 30, 31 and/or 32 of the BMS cards.

16 COMMISSIONING

Ensure that all modules and instrumentation are mounted and wired in accordance with local safety codes and design documentation then follow the steps outlined in the sections below to commission the system.



Warning: System settings and appliance configuration details must only be modified by qualified personnel familiar with the both the appliance under PF3100 control and related plant processes that could be affected.

16.1 PASSWORDS

Each setting and configuration wizard has a pre-defined security level based on its potential safety and reliability impact. To modify any setting, the password corresponding to its security level must first be entered. The security levels are as follows:

- L1 security level: Settings that do not impact the safety-integrity of the system but can impact operation.
- L2 security level: Settings that impact the safety-integrity of the system.
- L3 security level: Settings that impact fuel-air ratio control applications.

PF3100 passwords are not published publicly. Please refer to the documentation accompanying your PF3100 order or [Contact Profire](#) technical support.

16.2 UPDATE FIRMWARE

The firmware must match on (1) the User Interface, (2) all BMS controllers and (3) all connected I/O cards for the system to operate as intended.

1. Ensure all cards are powered on and connected to the PFRN communication network.
2. Update all cards to ensure that they are all running the same version of firmware. Refer to the [Firmware Update](#) section for instructions.
3. Use the [Network Discovery Tool](#) to troubleshoot firmware and communication issues.

16.3 USER INTERFACE SETTINGS

The User Interface settings (System Screen > Config Tab > Settings) apply to all appliances in the system.

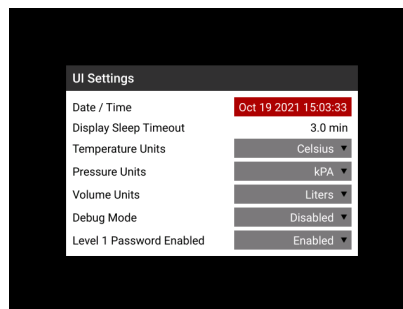
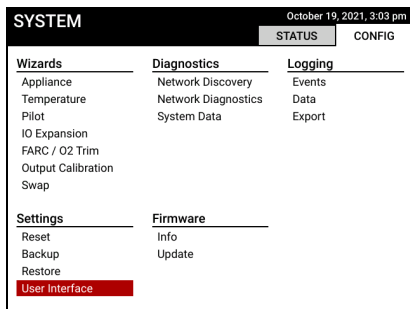

- Configure all User Interface settings as desired. The table below outlines the available configuration options:

Setting	Default	Options	Description	
Date / Time	Jan. 01, 1970	Any	Specifies the current date and time	
Display Sleep Timeout	3.0 min	0.5 min – 60 min	Specifies the time of user inactivity after which the UI screen turns off.	
Temperature Units	Celsius	C	Celsius	
		F	Fahrenheit	
Pressure Units	kPa	kPa	Specifies the display units for the BMS pressure input when Fuel Pressure Input Mode setting is set to 4-20.	
		PSI		Kilopascals
		inWC		Pounds per square inch
		cmWC		Inches of water column
		kg/cm ²		Centimeters of water column
		%		Kilograms per square centimeter
		mA		Percent
Volume Units	Liters	L	Specifies the display units for the BMS level/flow input when Level/Flow Input Mode setting is set to 4-20.	
		m ³		Liters
		Gal		Cubic meters
		BBL		US gallons
		%		Barrels
		mA		Percent
		L/min		Milliamps
Debug Mode	Disabled	Enabled	Appliance software diagnostic events are displayed to the user through an on-screen pop-up menu.	
		Disabled	Appliance software diagnostic events are hidden.	
Level 1 Password Enabled	Enabled	Enabled	The L1 password or higher must be used to access non-safety critical settings.	
		Disabled	The L1 settings can be modified with no password.	

16.4 APPLIANCE WIZARD

The Appliance Wizard is used to create and modify appliances and assign BMS Controller cards to each appliance.

16.4.1 CREATE APPLIANCE TAB

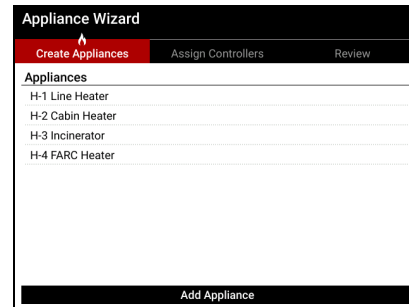
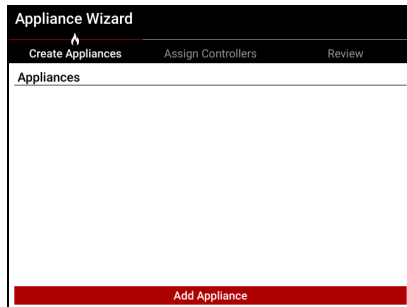

5. Select “Add Appliance” and create all the appliances that are to be controlled.
6. Name each appliance based on equipment tag, location, type, etc. to differentiate between them on screen (e.g., H-123, North Incinerator, Cabin Heater).
7. Press **→** then **▶** to advance to the Assign Controllers Tab.

16.4.2 ASSIGN CONTROLLERS TAB

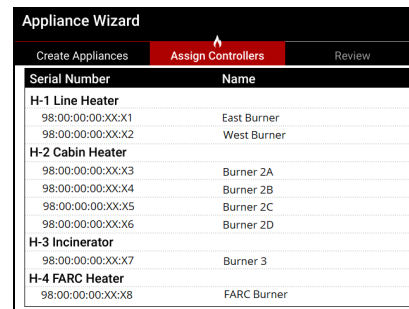
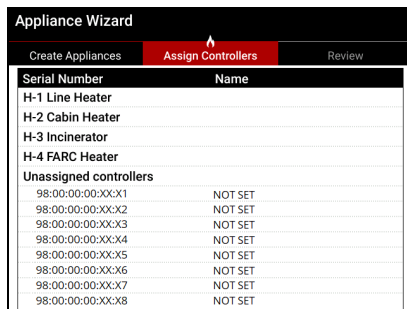

8. Assign each controller to its associated appliance to match field wiring. All connected BMS Controller cards are listed and identified by the serial numbers printed on the labels affixed to each card.
9. Name each controller to specify which burner it is controlling (e.g., East Burner, West Burner).
10. Press **→** then **▶** to advance to the Review Tab.

16.4.3 REVIEW TAB

11. Ensure that there are no errors and select “Accept” to save all changes and exit the Appliance Wizard.

16.5 TEMPERATURE WIZARD

The Temperature Wizard is used to create, assign and configure temperature inputs.

12. Select the appliance for which the temperature inputs are to be configured. Temperature inputs must be configured for each appliance separately.

16.5.1 CREATE INPUTS TAB

13. Select “Add Input” and create the temperature inputs associated with the selected appliance.

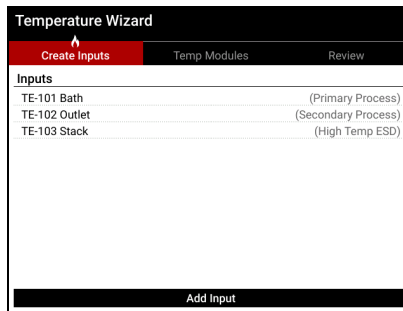

14. Configure and name each input based on design documentation. The table below describes the available configuration options.

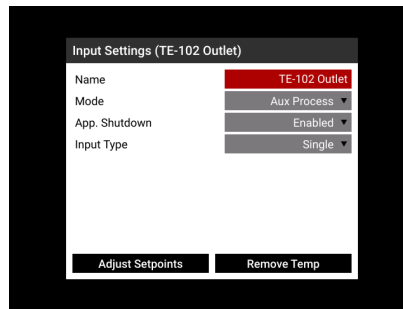

Setting	Default	Options	Description
Mode	Primary Process	Primary Process	The temperature input is used to determine system behavior and dictate state transitions.
		Disabled	The temperature input is ignored.
		Display Only	The temperature input readings are displayed to the user, but otherwise ignored.
		High Temp ESD	The temperature input is used to trigger high temperature shutdowns only.
		Aux Process	The temperature input is used in conjunction with the primary process temperature to determine system behavior and dictate state transitions.
App. Shutdown (Appliance Shutdown)	Enabled	Enabled	An input temperature reading above its corresponding High Temp setting shuts down all controllers in the appliance.
		Disabled	An input temperature reading above its corresponding High Temp setting shuts down only the controller to which it is connected.
Input Type	Dual	Single	The temperature input is a single-element thermocouple.
		Dual	The temperature input is a dual-element thermocouple.

16.5.1.1 ADJUST SETPOINTS DIALOG

15. Select “Adjust Setpoints” to configure the setpoints and process settings for each input in accordance with design specifications. The table below describes the available configuration options.

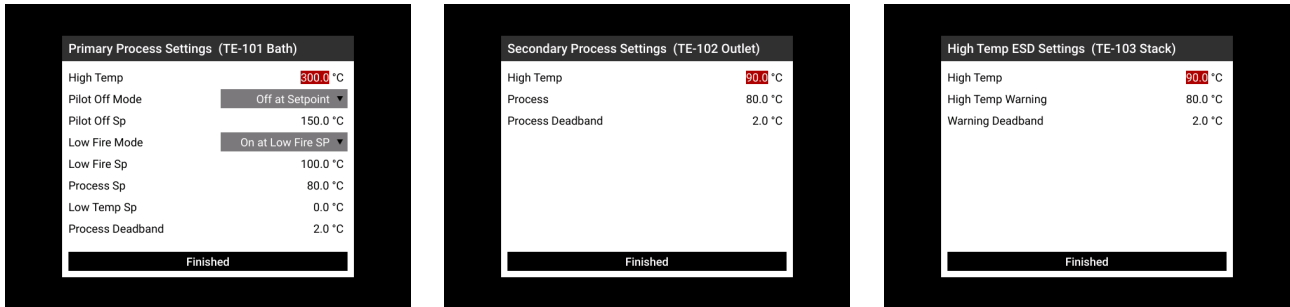

Setting	Default	Options	Description
High Temp	90 °C 194 °F	0 °C – 1350 °C 32 °F – 2462 °F	Specifies the process temperature above which (1) the appliance shuts down or (2) controller shuts down, in accordance with the App. Shutdown setting above.
Pilot Off Mode	Off At Setpoint	Disabled	The pilot valve outputs are de-energized when the process temperature is above the configured High Temp SP.
		Off At Setpoint	The pilot valve outputs are de-energized when the process temperature is above the configured Pilot Off SP.
		Off After Main On	The pilot valve outputs are de-energized after the main valves are energized.
		Follow Main	The pilot valve outputs are de-energized with the main valves when the process temperature is above the configured Low Fire SP.
Pilot Off SP	85 °C 185 °F	0 °C – 1350 °C 32 °F – 2462 °F	Specifies the process temperature at which the pilot valve outputs are de-energized when Pilot Off Mode is set to Off At Setpoint.
Low Fire Mode	Disabled	Disabled	The main valves are de-energized when the process temperature is above the configured Process SP. <small>* It is recommended that Low Fire Mode is enabled for all applications over 1 000 000 Btuh.</small>
		On At Process SP	The main valve outputs are energized when the process temperature drops below the configured Process Temp SP minus deadband.
		On At Lowfire SP	The main valve outputs are energized when the process temperature drops below the configured Low Fire SP minus deadband.
Low Fire SP	85 °C 185 °F	0 °C – 1350 °C 32 °F – 2462 °F	Specifies the process temperature at which the main valve outputs are de-energized when Low Fire Mode is enabled.
Process SP	80 °C 176 °F	0 °C – 1350 °C 32 °F – 2462 °F	Specifies the process temperature that the system attempts to maintain.
Process Deadband	2 °C 3.6 °F	0 °C – 100 °C 3.6 °F – 180 °F	Specifies the deadband applied around the Process setpoint to prevent fluctuation between states when the process temperature is near the setpoint.
Low Temp SP	0 °C 32 °F	0 °C – 1350 °C 32 °F – 2462 °F	Specifies the process temperature below which the system displays a warning on the Appliance Alerts Screen.
High Temp Warning	80 °C 176 °F	0 °C – 1350 °C 32 °F – 2462 °F	Specifies the temperature above which the system displays a high temperature warning on the Appliance Alerts Screen.
Warning Deadband	2 °C 3.6 °F	0 °C – 100 °C 3.6 °F – 180 °F	Specifies the deadband applied around the High Temp Warning setting to prevent the high temperature warning from setting and clearing sporadically when the temperature is near the setpoint.

16. Select “Finished” then press then to advance to the Temp Modules Tab.

16.5.2 TEMP MODULES TAB

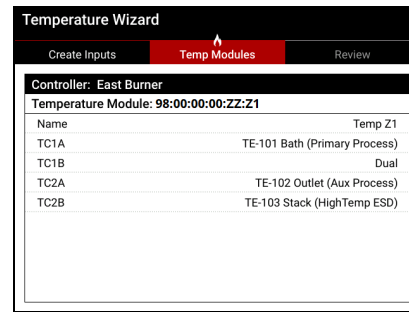
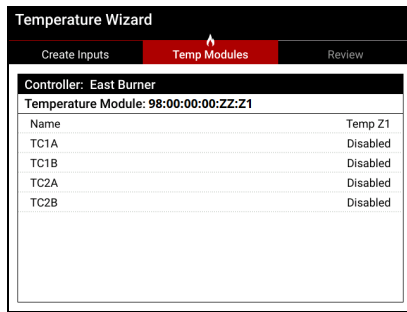

17. Name each temperature card and assign each input to its corresponding card as wired in the field (e.g., ensure that the temperature card physically installed in the appliance bath corresponds to the Bath input from the [Create Inputs tab](#)).
18. Press then to advance to the Review Tab.

16.5.3 REVIEW TAB

19. Ensure that there are no errors and select “Accept” to save all changes and exit the Temperature Wizard.

16.6 PILOT WIZARD

The Pilot Wizard is used to configure ignition settings and assign connected Ion Pilot and UV Pilot cards for each appliance.

20. Select the appliance for which the pilot cards are to be configured. Pilot cards must be configured for each appliance separately.

16.6.1 ALLOCATE PILOT TAB

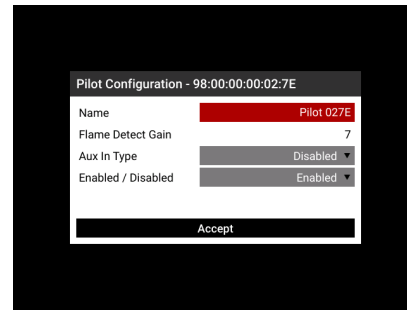
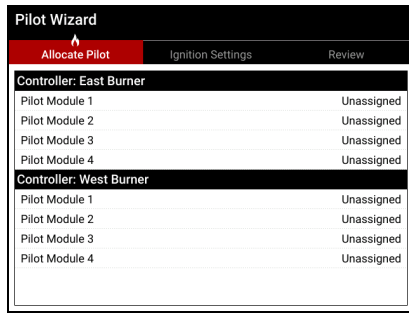

21. Select a slot and press **OK** to open a list of MAC addresses associated with all connected pilot cards. Select desired card and press **OK**.
22. Configure card settings per design specifications and repeat for all connected pilot cards. The table below outlined the configuration options available.

Setting	Default	Options	Description
Name	Pilot Module	Any up to 16 characters long.	Specifies the name of the selected Pilot card.
Flame Detection Gain <small>* Only visible for Ion Pilot cards</small>	7	3 - 7	Specifies the flame signal amplification level.
Ion Aux In Type <small>* Only visible for Ion Pilot cards</small>	Disabled	Disabled	The Ion Aux input is ignored.
		Dry Contact	The Ion Aux input is configured as a dry contact input
		4-20 Input	The Ion Aux input is configured as a 4-20mA input and affects system behavior in accordance with the Ion Aux Input settings.
Enabled/Disabled	Enabled	Enabled	The pilot card is used by the system for ignition/flame detection in accordance with the configured settings.
		Disabled	The ignition card is ignored by the system.

23. Press **→** then **▶** to advance to the Ignition Settings Tab.

16.6.2 IGNITION SETTINGS TAB

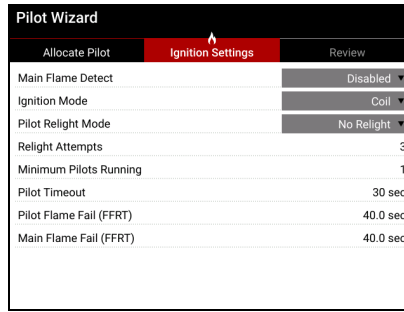

24. Configure appliance-wide ignition settings per design specifications. The table below outlines the available configuration options:

Setting	Default	Options	Description
Main Flame Detect	Disabled	Enabled	Main flame detection is required.
		Disabled	Main flame detection is not required.
Ignition Mode	Coil	Coil	The Ion Pilot card coil output is connected to an ignition coil.
		HEI	The Ion Pilot card coil output is connected to a separate ignition module with DC input to control sparking.
Pilot Relight Mode	No Relight	No Relight	Lost pilot flames are not automatically reignited.
		During Flame Fail	The controller attempts to reignite lost pilot flames for the duration of the Pilot Flame Fail (FFRT) setting.
		During Timeout	Minimum Pilots Running requirement satisfied: The controller attempts to reignite lost pilot flames for the duration of the configured Pilot Relight Timeout setting. Minimum Pilots Running requirement not satisfied: The controller attempts to reignite lost pilot flames for the duration of the configured Pilot Flame Fail (FFRT) setting.
Relight Attempts	3 attempts	0 – 3 attempts	Specifies the number of relight attempts allowed following a flame failure.
Minimum Pilots Running	1	1 – 4 pilots	Specifies the number of pilots that must have flame proven for the controller to remain running.
Pilot Relight Timeout	30 s	10 s – 600 s	Specifies the duration for which the system attempts to reignite lost pilot flames in multi-pilot applications when the Minimum Pilots Running requirement is satisfied and Pilot Relight Mode is set to During Timeout.
Pilot Flame Fail (FFRT)	4 s	0.8 s – 4 s	Specifies the time between pilot flame failure and controller shutdown (or restart if allowable relights remain). * Time starts when Minimum Pilots Running setting is not satisfied.
Main Flame Fail (FFRT)	4 s	0.8 s – 4 s	Specifies the time between main flame failure and controller shutdown (or restart if allowable relights remain). * Time starts when no main flame detectors are detecting flame.

25. Press then to advance to the Review Tab.

16.6.3 REVIEW TAB

26. Ensure that there are no errors and select “Accept” to save all changes and exit the Pilot Wizard.

16.7 I/O EXPANSION WIZARD

The I/O Expansion Wizard is used to configure inputs and outputs for use with the IO Expansion Card.

16.7.1 SELECT APPLIANCE SCREEN

27. Select the appliance for which the I/O expansion inputs are to be configured. I/O expansion inputs must be configured for each appliance separately.

16.7.2 ADD INPUTS TAB

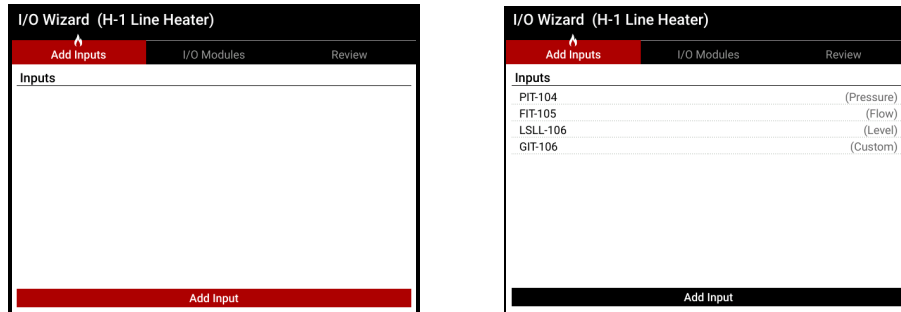

28. Select "Add Input" and follow the on-screen menus to set up all required inputs per design documentation. The table below outlines the configuration options available:

Setting	Options	Description
Input Type	Pressure	The input represents a fuel pressure device.
	Flow	The input represents a process flow device.
	Level	The input represents a fluid level device.
	Custom	The input represents a generic input device.
	Appliance Firing Rate	The input represents an external 4-20mA firing rate signal.
	FARC Fuel Position	The input represents a 4-20mA fuel actuator position feedback signal.
	FARC Air Position	The input represents a 4-20mA air actuator position feedback signal.
	Bleed Valve Proof of Open	The input represents a bleed valve proof of open switch.
	FARC Aux Position	The input represents a 4-20mA FARC actuator position feedback signal.
	O ₂ Sensor Reading	The input represents a 4-20mA oxygen concentration sensor.
Signal Type	Digital	The input represents a switch.
	4-20	The input represents 4-20mA transmitter.
Input Mode	Alarm	Input trip shuts down the controller and prevents starting until cleared.
	Wait	Input trip transitions the controller to the Waiting state and prevents transitions to any fuel state until cleared.
	Warning	Input trip generates an alert but does not affect system behavior.
	Main Permissive	Input trip transitions the controller out of any main fuel state and prevents re-entry until cleared.
	Local Proof of Airflow	Input trip shuts down the controller when attempting to prove airflow.
	Secondary PID Input	The input is used for PID control in accordance with the Advanced PID Control settings.
	Display Only	The input does not generate alerts or otherwise affect system behavior.
Name	Any	Specifies the input name displayed on the Appliance Status Screen.
Units	Pressure/Temperature/Level/Flow/Custom units	Specifies the input units displayed on the Appliance Status Screen.
Low Setpoint	Any	Specifies the threshold below which a low trip event occurs.
High Setpoint	Any	Specifies the threshold above which a high trip event occurs.
Deadband	Any above 0	Specifies the deadband applied around each setpoint to prevent fluctuation between states when input is near the trip points.

29. Press then to advance to the I/O Modules Tab.

16.7.3 I/O MODULES TAB

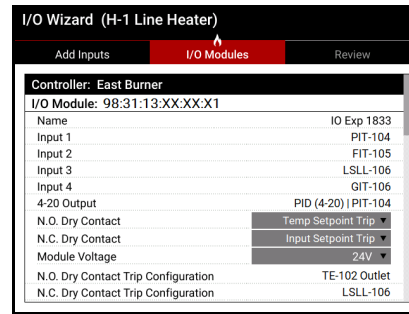
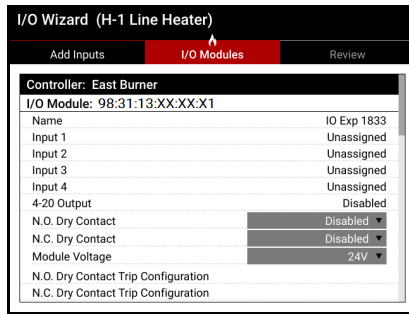

- 30. Name each card and assign each created input to the physical input location to which it is wired in the field. Note that a single created (non-FARC) input can be assigned to multiple physical inputs for redundancy.
- 31. Configure 4-20 Output mode, Dry Contact behavior and Module Voltage per design documentation. The table below outlines the configuration options available.

Setting	Options	Description
Name	Any up to 16 characters long	Specifies the name of the selected I/O Expansion card.
Input 1	Any input created on the Add Inputs tab	Specifies the input device wired to terminals 8, 9 and 10 on the I/O Expansion card.
Input 2	Any input created on the Add Inputs tab	Specifies the input device wired to terminals 11, 12 and 13 on the I/O Expansion card.
Input 3	Any input created on the Add Inputs tab	Specifies the input device wired to terminals 14, 15 and 16 on the I/O Expansion card.
Input 4	Any input created on the Add Inputs tab	Specifies the input device wired to terminals 17, 18 and 19 on the I/O Expansion card.
4-20 Output	PID Output Controlled by 4-20mA Input	The I/O Expansion 4-20mA output is modulated in accordance with the PID configuration parameters .
	PID Output Controlled by TC Input	
	Air Position Controlled by FARC	The I/O Expansion 4-20mA output is connected to a proportional airflow actuator for a fuel-air ratio control application.
	Aux Position Controlled by FARC	The I/O Expansion 4-20mA output is connected to a proportional actuator for a multi-channel fuel-air ratio control application.
N.O. Dry Contact/ N.C. Dry Contact	Disabled	Refer to I/O Expansion card Normally Closed Dry Contact and Normally Open Dry Contact sections for behavior in each mode.
	Started Status	
	High Temp Status	
	No Alert Status	
	Appliance Proc Control	
	Controller Proc Control	
	Temp Setpoint Trip	
	Input Setpoint Trip	
Module Voltage	12V	The I/O Expansion PWR Out terminals supply 12V.
	24V	The I/O Expansion PWR Out terminals supply 24V.
Dry Contact Trip Configuration <small>* Only applicable when Dry Contact mode above is set to Temp Setpoint Trip or Input Setpoint Trip.</small>	Any configured temperature input	Specifies the temperature input used to determine dry contact behavior.
	Any configured I/O expansion input	Specifies the I/O Expansion input used to determine dry contact behavior.

16.7.3.1 PID CONFIGURATION PARAMETERS

The PID Configuration menu is accessed by (1) configuring the I/O Expansion 4-20 Output as a PID control output, or (2) selecting a configured I/O Expansion 4-20 PID output from the Appliance Status Screen.

32. Configure all I/O Expansion PID parameters per design documentation. The table below outlines the configuration options available:

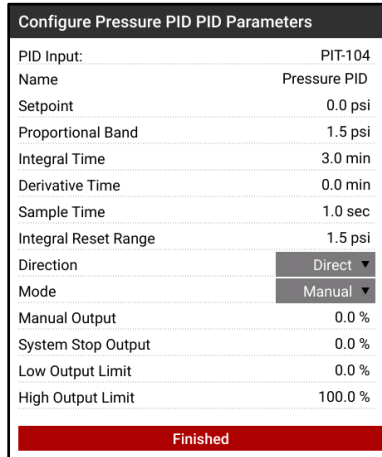

Setting	Options	Description
PID Input		Indicates the I/O Expansion input(s) for which the following configuration applies. All selected inputs are averaged to determine the input reading used by the PID output.
Name	Any	Specifies the name displayed on the Appliance Status Screen representing the I/O Expansion PID output.
Setpoint	Any	Specifies the PID Input reading that the system attempts to maintain.
Proportional Band	Any	Specifies the proportional term used by the I/O Expansion PID algorithm.
Integral Time	0 min - Any	Specifies the integral term used by the I/O Expansion PID algorithm.
Derivative Time	0 min - Any	Specifies the derivative term used by the I/O Expansion PID algorithm.
Sample Time	0 sec - Any	Specifies the time between samples for the I/O Expansion PID algorithm.
Integral Reset Range	Any	Specifies the range above and below the input Setpoint within which the I/O Expansion PID integral error accumulates.
Direction	Direct	Specifies that the I/O Expansion PID output increases as the input increases.
	Reverse	Specifies that the I/O Expansion PID output decreases as the input increases.
Mode	Auto	The I/O Expansion 4-20 Output is modulated automatically by the I/O Expansion PID algorithm based on the configured PID settings above.
	Manual	The I/O Expansion 4-20 Output delivers a 4-20mA signal in accordance with the configured Manual Output setting below.
Manual Output	0 % - 100 %	Specifies the I/O Expansion 4-20 Output signal when in Manual Mode.
System Stop Output	0 % - 100 %	Specifies the I/O Expansion 4-20 Output signal when the controller is stopped.
Low Output Limit	0 % - 100 %	Specifies the lowest possible output value for the I/O Expansion 4-20 Output.
High Output Limit	0 % - 100 %	Specifies the highest possible output value for the I/O Expansion 4-20 Output.

33. Select "Finished" and press **OK** to return to the I/O Modules Tab.

34. Press **⇒** then **▶** to advance to the Review Tab.

16.7.4 REVIEW TAB

35. Ensure that there are no errors and select "Accept" to save all changes and exit the I/O Expansion Wizard.

16.8 OUTPUT CALIBRATION WIZARD

The Output Calibration Wizard is used to calibrate the BMS card and I/O Expansion card 4-20 mA outputs.

36. Disconnect field device from output to be calibrated and connect a process calibrator in its place.

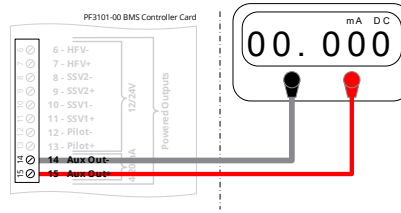

16.8.1 OUTPUTS TAB

37. Select the appropriate output from the list and press **OK**.

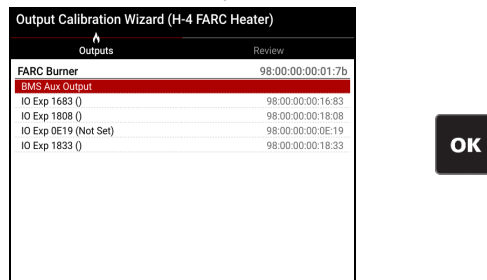

38. Adjust the 4mA value to match the reading on the process calibrator using **+** and **-**.

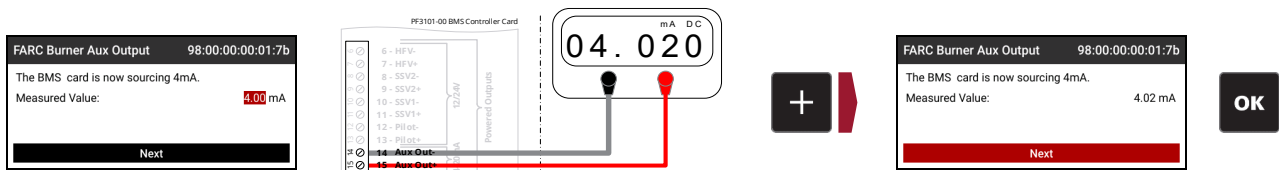

39. Adjust the 20mA value to match the reading on the process calibrator using **+** and **-**.

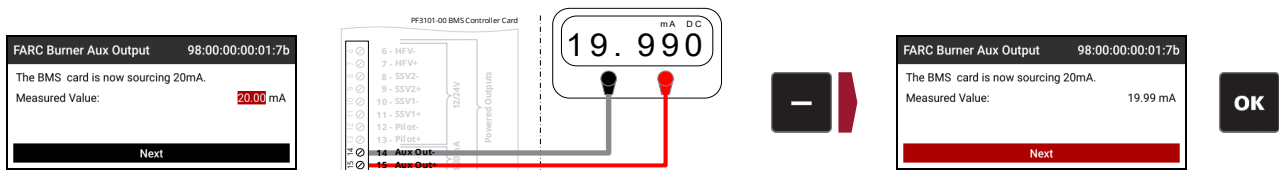

40. Check the calibration. Use **+** and **-** to change the output value and verify against the process calibrator reading.

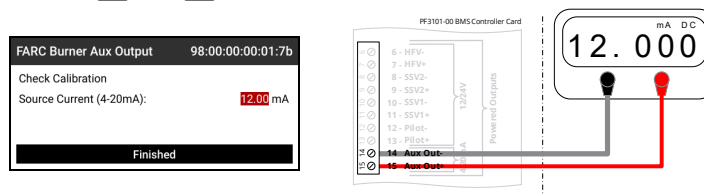

- 41. Reconnect field device.
- 42. Repeat above steps for all outputs listed.
- 43. Press **⇒** then **▶** to advance to the Review Tab.

16.8.2 REVIEW TAB

44. Ensure that there are no errors and select "Accept" to save all changes and exit the Output Calibration Wizard.

16.9 FARC/O₂ TRIM WIZARD

The FARC/O₂ Trim Wizard is used to configure fuel-air ratio curves, define oxygen trimming profiles and specify configuration parameters associated with single-burner fuel-air ratio control applications. Users require a L3 password to access the FARC/O₂ Trim Wizard - all configuration should be done by a FARC expert.

- Before accessing the FARC/O₂ Trim Wizard, first ensure that all FARC inputs and outputs are created and assigned in the [I/O Expansion Wizard](#).

16.9.1 GENERAL TAB

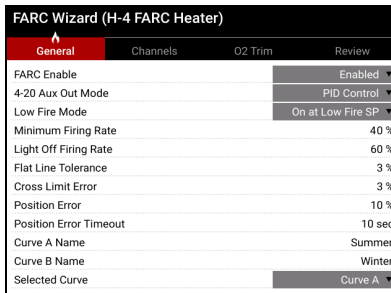

- Configure FARC settings per design documentation in accordance with the table below:

Setting	Options	Description
FARC Enable	Enabled	Specifies that all FARC inputs, outputs and curves are used by the system. * Note that the HFV Output Mode is automatically changed to Forced Draft Fan when FARC is enabled.
	Disabled	Specifies that all FARC inputs, outputs and curves are ignored by the system.
4-20 Aux Out Mode	PID Control	Refer to 4-20 Aux Output Mode setting for descriptions. While this setting has multiple configuration options, only the options listed to the left are available for FARC applications.
	Appliance Firing Rate	
Low Fire Mode	On at Process SP	Refer to the Low Fire Mode setting for descriptions. While this setting has multiple configuration options, only the options listed to the left are available for FARC applications.
	On at Low Fire SP	
Minimum Firing Rate	0 - 70%	Specifies the minimum allowable firing rate when in a main state.
Light Off Firing Rate	0 - 100%	Specifies the firing rate at which the controller holds during light off of the main burner.
Flat Line Tolerance	1 - 10%	Specifies the tolerance applied around flat portions of a FARC curve where the internal flat line cross limiting algorithm is used.
Cross Limit Error	0 - 15%	Specifies the maximum tolerance by which the requested channel position may differ from its actual position when the channel is actively being cross limited and a fuel-rich* condition is created. * Applies to any lagging channel - not just fuel.
Position Error	0 - 10%	Specifies the maximum tolerance by which the requested channel position and its actual position may differ.
Position Error Timeout	1 - 10 sec	Specifies the time for which a position error must be present before the system acts.
Curve A Name	Any	Specifies the name of FARC Curve A. (e.g., "Summer Profile")
Curve B Name	Any	Specifies the name of FARC Curve B. (e.g., "Winter Profile")
Selected Curve	Curve A	Specifies that the system uses FARC Curve A.
	Curve B	Specifies that the system uses FARC Curve A.

- Press then to advance to the Channels Tab.

16.9.2 CHANNELS TAB

The Channels Tab is populated automatically with the FARC channels configured in the I/O Expansion Wizard.

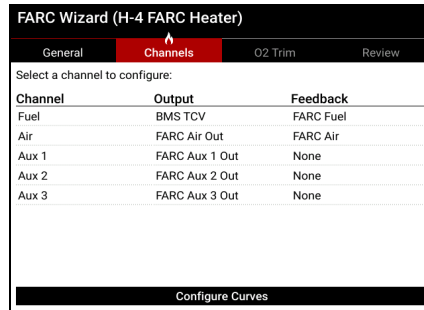

48. Press to select a channel and to open its channel-specific configuration window. Configure per design documentation and repeat for each channel. The table below outlines the configuration options available:

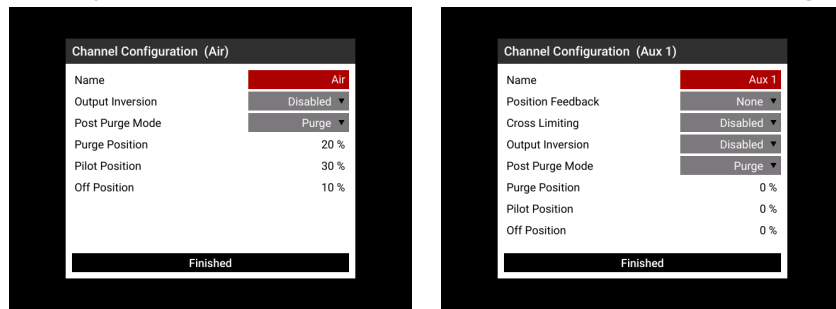

Setting	Options	Description
Name	Any	Specifies the name of the selected FARC channel.
Position Feedback	None or any I/O Expansion input configured as a FARC Aux feedback input.	Specifies the feedback input that corresponds to the channel output. * This option is not available for the Air and Fuel channels as a feedback input for these channels is not optional.
Cross Limiting	Disabled	Specifies that cross limiting is not applied to the selected channel. * This option is not available for the Air and Fuel channels.
	Lead	Specifies channel output leads the fuel output upon firing rate increase. * The Air channel is a leading channel and cannot be changed.
	Lag	Specifies channel output lags the air output upon firing rate increase. * The Fuel channel is a lagging channel and cannot be changed.
Output Inversion	Disabled	Specifies that the 0% position of the connected actuator corresponds to a 4mA input signal.
	Enabled	Specifies that the 100% position of the connected actuator corresponds to a 4mA input signal.
Post Purge Mode	Purge	Specifies that the channel output is driven to its configured Purge Position while post purging.
	Hold Last	Specifies that the channel output is held at its current position while post purging.
Purge Position	0 – 100 %	Specifies the channel output position when the system is purging.
Pilot Position	0 – 100 %	Specifies the channel output position when in the Pilot state.
Off Position	0 – 100 %	Specifies the channel output position when stopped and not purging.

49. Select “Configure Curves” to set up the FARC profile tables.

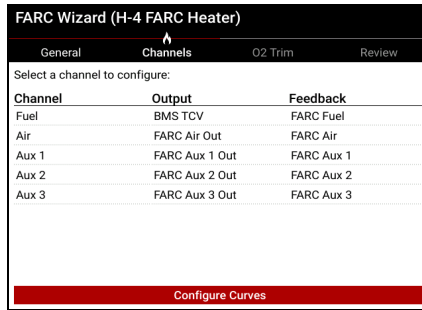

50. Configure the table in accordance with safety design documentation and manufacturer specifications as well as the slope and feedback requirements outlined in the table below for each channel at each firing rate increment. Refer to the [PF3100 FARC User Guide](#) for detailed configuration instructions.

Scenario		Slope Requirement	Position feedback requirement
Channel	Cross limiting setting		
Air	N/A – Always enabled	Cannot decrease	N/A – Always enabled
Fuel			
Aux	Enabled	Cannot change direction	Must be enabled
	Disabled	No requirements	Not required

* All unconfigured columns on the table are linearly interpolated from the configured points.

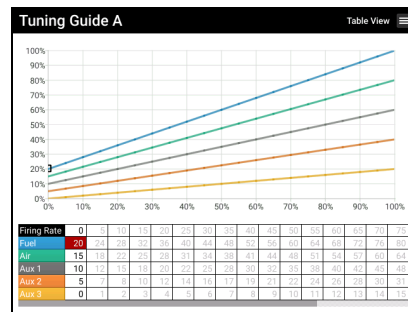
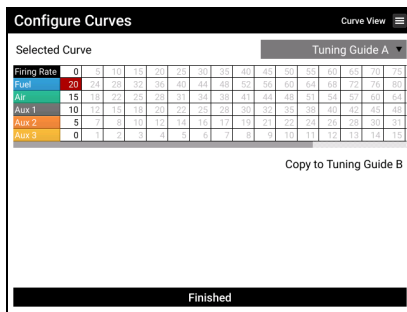

51. Ensure that both Curve A and Curve B are configured correctly and select “Finished”.

52. Press then to advance to the O₂ Trim Tab.

16.9.3 O₂ TRIM TAB

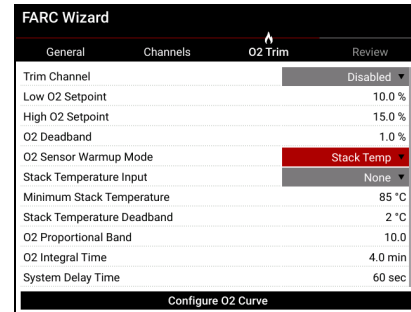
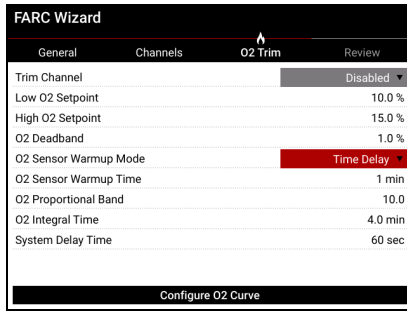

53. Configure O₂ Trim settings in accordance with safety design documentation and heater manufacturer specifications. Refer to the [PF3100 FARC User Guide](#) for detailed configuration instructions. The table below outlines the configuration settings available:

Setting	Options	Description
Trim Channel	Air	Specifies the FARC channel to which the O ₂ trim profile is applied.
	Fuel	
	Disabled	
Low O ₂ Setpoint	0 – 22%	Specifies the O ₂ sensor input threshold below which the system registers a low O ₂ event.
High O ₂ Setpoint	0 – 22%	Specifies the O ₂ sensor input threshold above which the system registers a high O ₂ event.
O ₂ Deadband	0 - 3 %	Specifies the deadband applied around each configured trip point to prevent fluctuation between states.
O ₂ Sensor Warmup Mode	Time Delay	Specifies that the O ₂ Trim table is ignored until the configured O ₂ Sensor Warmup Time has elapsed.
	Stack Temp	Specifies that the O ₂ Trim table is ignored until the system reached the Process Control state and the configured Stack Temperature Input has reached the configured Minimum Stack Temperature.
O ₂ Sensor Warmup Time	1 – 100 sec	Specifies the time after entering Process Control for which to wait before initiating O ₂ trim when O ₂ Sensor Warmup Mode is set to Time Delay.
Stack Temperature Input	Any configured High Temp ESD or Aux Process input from the Temperature Wizard .	Specifies the temperature input used to determine appliance warmup.
Minimum Stack Temperature	0 – 1350 °C	Specifies the temperature above which O ₂ trim is initiated.
Stack Temperature Deadband	0 – 100 °C	Specifies the deadband applied around the Minimum Stack Temperature setting to prevent fluctuation between enabling and disabling of O ₂ Trim.
O ₂ Proportional Band	1 - 1000	Specifies the proportional term with respect to transmitter span used by the O ₂ Trim PI algorithm.
O ₂ Integral Time	0 – 100 min	Specifies the integral term used by the O ₂ Trim PI algorithm.
System Delay Time	1 – 300 sec	Specifies the sample time used by the O ₂ Trim PI algorithm.

54. Select "Configure O₂ Curve" to configure the oxygen trimming profiles.
55. Specify Target O₂, Max Trim and Min trim values for every firing rate increment. All unconfigured columns on the table are linearly interpolated from the configured points.

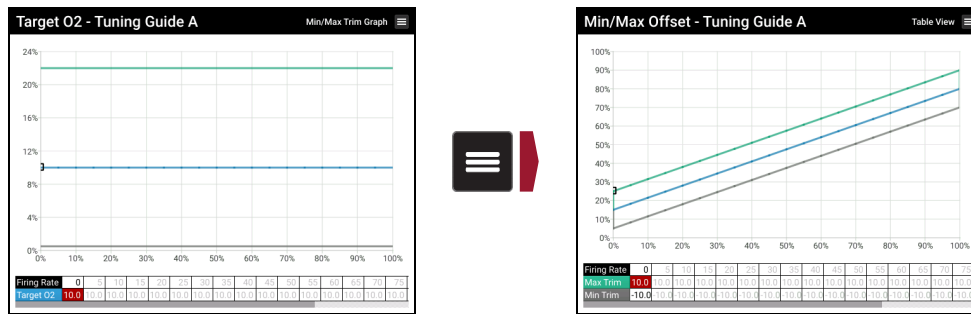

56. Ensure that O₂ trim profiles for both Curve A and Curve B are configured correctly and select "Finished".
57. Press then to advance to the Review Tab.

16.9.4 REVIEW TAB

58. Ensure that there are no errors and select "Accept" to save all changes and exit the FARC/O₂ Trim Wizard.

16.10 BMS CONTROLLER SETTINGS

The settings below are available for all connected controllers. Settings are linked across controllers by default for multi-controller appliances. Select a setting and press  to adjust for each controller independently.

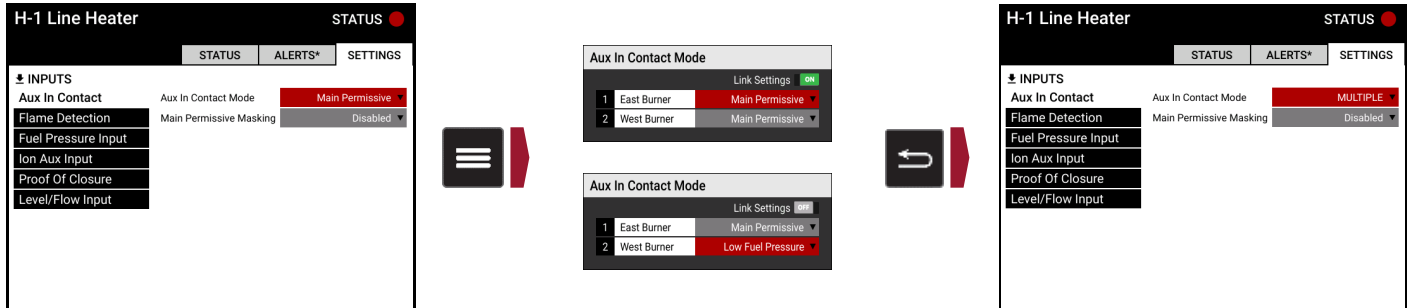

59. Configure all BMS settings below for each connected controller in accordance with manufacturer specifications and safety design documentation.

16.10.1 PROCESS CONTROL

16.10.1.1 PROCESS TEMP CONTROL

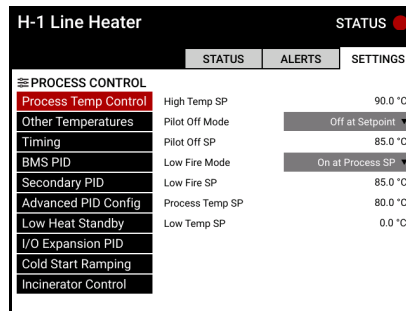

Setting	Default	Options	Description
High Temp SP	90 °C 194 °F		Refer to Temperature Wizard Adjust Setpoints Dialog above for configuration options and descriptions.
Pilot Off Mode	Off At Setpoint		
Pilot Off SP	85 °C 185 °F		
Low Fire Mode	Disabled		
Low Fire SP	85 °C 185 °F		
Process Temp SP	80 °C 176 °F		
Low Temp SP	0 °C 32 °F		

16.10.1.2 OTHER TEMPERATURES

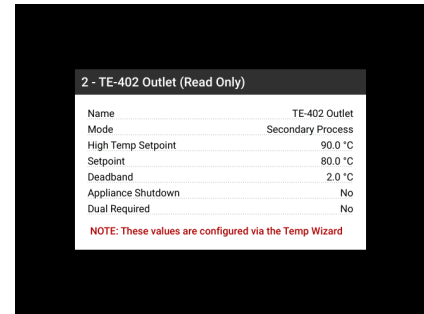
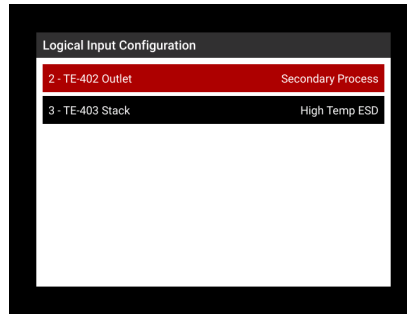
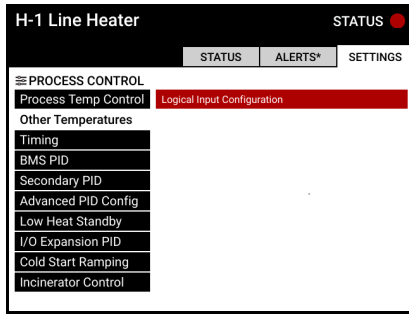

The Process Temp Control settings above pertain only to the primary process temperature input. The Logical Input Configuration link shown in the Other Temperatures menu can be used to view the settings of all configured temperatures. Changes to the settings must be made in the [Temperature Wizard](#).

16.10.1.3 TIMING

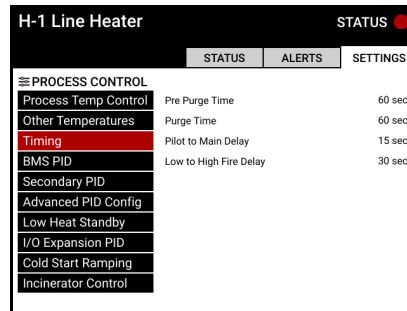

Setting	Default	Options	Description
Pre Purge Time	60 s	10s - 900 s	Specifies the duration of the Proven Pre-Purge controller state, when applicable.
Purge Time	60 s	10 s - 900 s	Specifies the time for which the system purges upon power up and following a lockout.
Pilot to Main Delay	15 s	5 s - 600 s	Specifies the time for which the system remains in the Pilot state before proceeding to light off the main valves.
Low to High Fire Delay	30 s	30 s - 600 s	Specifies the time for which the system remains in the Low Fire state before proceeding to High Fire.

16.10.1.4 BMS PID

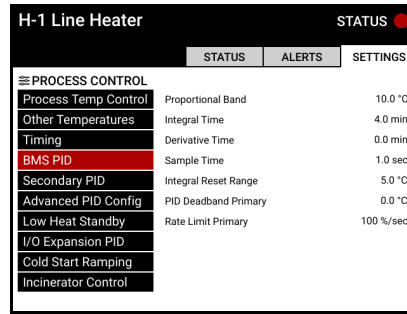

Setting	Default	Options	Description
Proportional Band	10 °C 18 °F	0.1 °C – 999.9 °C 0.2 °F – 1799.8 °F	Specifies the proportional term used by the primary PID algorithm.
Integral Time	4 min	0 min – 999.9 min	Specifies the integral term used by the primary PID algorithm.
Derivative Time	0 min	0 min – 999.9 min	Specifies the derivative term used by the primary PID algorithm.
Sample Time	1 s	0.1 s – 99999 s	Specifies the time between samples for the primary PID algorithm.
Integral Reset Range	5 °C 9 °F	0 °C - 1350 °C 0 °F - 2430 °F	Specifies the range above and below the Process Setpoint within which the primary PID integral error accumulates.
PID Deadband Primary	0 °C 0 °F	0 °C – 10 °C 0 °F – 18 °F	Specifies the primary PID deadband applied to limit fluctuation between states when the primary process temperature is near configured setpoints.
Rate Limit Primary	100%/s	1 %/s – 100 %/s	Specifies the maximum rate of change of the BMS Controller Aux output during primary PID control.

16.10.1.5 SECONDARY PID

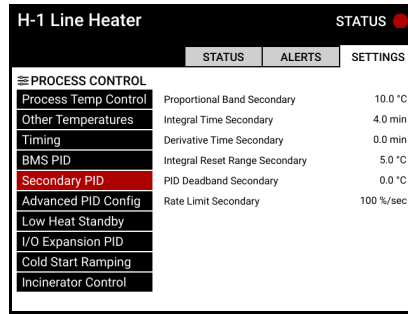

Setting	Default	Options	Description
Proportional Band Secondary	10 °C 18 °F	0.1 °C – 999.9 °C 0.2 °F – 1799.8 °F	Specifies the proportional term used by the secondary PID algorithm.
Integral Time Secondary	4 min	0 min – 999.9 min	Specifies the integral term used by the secondary PID algorithm.
Derivative Time Secondary	0 min	0 min – 999.9 min	Specifies the derivative term used by the secondary PID algorithm.
Integral Reset Range Secondary	5 °C 9 °F	0 °C - 1350 °C 0 °F - 2430 °F	Specifies the range above and below the secondary process setpoint within which the secondary PID integral error accumulates.
PID Deadband Secondary	0 °C 0 °F	0 °C – 10 °C 0 °F – 18 °F	Specifies the secondary PID deadband applied to limit fluctuation between states when the secondary process temperature is near configured setpoints.
Rate Limit Secondary	100%/s	1 %/s – 100 %/s	Specifies the maximum rate of change of the BMS Controller Aux output during secondary PID control.

16.10.1.6 ADVANCED PID CONFIG

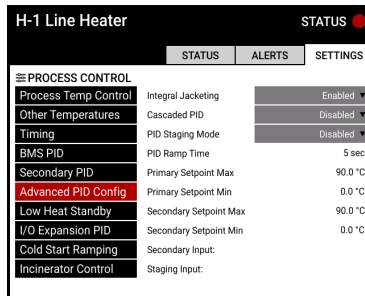

Setting	Default	Options	Description
Integral Jacketing	Enabled	Enabled	PID integral error does not accumulate when the PID output is operating at 100% or at its configured Minimum Position.
		Disabled	PID integral error continues to accumulate when the PID output is operating at 100% or at its configured Minimum Position.
Cascaded PID	Disabled	Enabled	Cascaded PID is enabled
		Disabled	Cascaded PID is disabled
PID Staging Mode	Disabled	Disabled	The system controls based on the Primary process temperature only.
		High Input	The system switches from primary to secondary input control when the configured Staging Input is above its High Trip setpoint .
		Low Input	The system switches from primary to secondary input control when the configured Staging Input is below its Low Trip setpoint .
		Primary In Range	The system switches from primary to secondary input control when the primary temp is above the configured Primary Setpoint Min setting.
		Secondary In Range	The system switches from primary to secondary input control when the configured secondary temperature is between the configured Secondary Setpoint Min and Secondary Setpoint Max settings below.
		Primary AND Secondary in Range	The system switches from primary to secondary input control when both the primary and secondary temperatures are between their configured Setpoint Min and Setpoint Max settings below.
		Primary OR Secondary in Range	The system switches from primary to secondary input control when either the primary or secondary temperature is between its configured Setpoint Min and Setpoint Max settings below.
PID Ramp Time	5 s	0 s – 60 s	Specifies the time the BMS controller Aux output takes to ramp to 100% upon entry into the PID control state.
Primary Setpoint Max	90 °C 194 °F	0 °C - 1350 °C 32 °F - 2462 °C	Specifies the maximum value to which the primary process setpoint can be changed by the system. * Must be set between the configured Process Setpoint and Low Fire Setpoint .
Primary Setpoint Min	0 °C 32 °F	0 °C - 1350 °C 32 °F - 2462 °C	Specifies the minimum value to which the primary process setpoint can be changed by the system. * Must be set between the configured Process Setpoint and Low Temp Setpoint .
Secondary Setpoint Max	90 °C 194 °F	0 °C - 1350 °C 32 °F - 2462 °C	Specifies the maximum value to which the secondary process setpoint can be changed by the system. * Must be set between the configured Process Setpoint and Low Fire Setpoint .
Secondary Setpoint Min	0 °C 32 °F	0 °C - 1350 °C 32 °F - 2462 °C	Specifies the minimum value to which the secondary process setpoint can be changed by the system. * Must be set between the configured Process Setpoint and Low Temp Setpoint .
Secondary Input	-	Any temperature or Secondary PID I/O Expansion Input	Specifies the input used as a secondary PID input.
Staging Input	-	Any configured I/O expansion input	Specifies the I/O Expansion input used as a staging input

16.10.1.7 LOW HEAT STANDBY

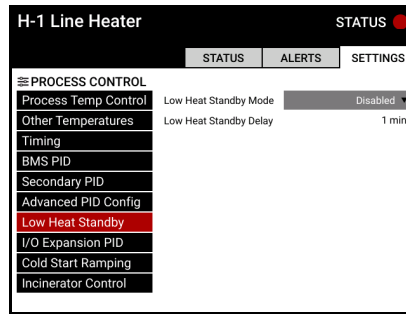

Setting	Default	Options	Description
Low Heat Standby Mode	Disabled	Disabled	The controller does not use Low Heat Standby functionality
		Wait	Specifies that the controller transitions to the Waiting state if all the following conditions are met for the duration of the Low Heat Standby Delay setting: <ol style="list-style-type: none"> 1. The controller is in the PID Control state. 2. The process temperature is between the Process setpoint and Low Fire Setpoint. 3. Basic PID: The firing rate is at the configured Minimum Firing Rate. Cascaded PID: The Primary setpoint is at the configured Primary Setpoint Min setting.
		Main Permissive	Specifies that the controller transitions to the Pilot state if all the following condition are met for the duration of the Low Heat Standby Delay setting: <ol style="list-style-type: none"> 1. The controller is in the PID Control state. 2. The process temperature is between the Process setpoint and Low Fire Setpoint. 3. Basic PID: The firing rate is at the configured Minimum Firing Rate. Cascaded PID: The Primary setpoint is at the configured Primary Setpoint Min setting.
Low Heat Standby Delay	1 min	1 min – 1440 min	Specifies the time for which the Low Heat Standby conditions must be met for the system to initiate a Low Heat Standby state transition.

16.10.1.8 I/O EXPANSION PID

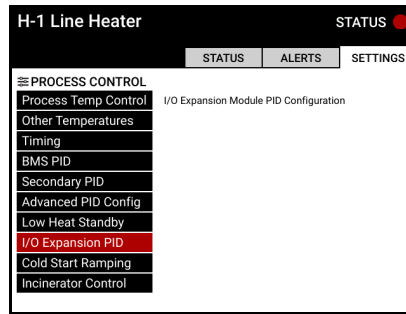

The I/O Expansion Card PID Configuration link can be used to access the [PID configuration settings](#) for the I/O Expansion card inputs.

16.10.1.9 COLD START RAMPING

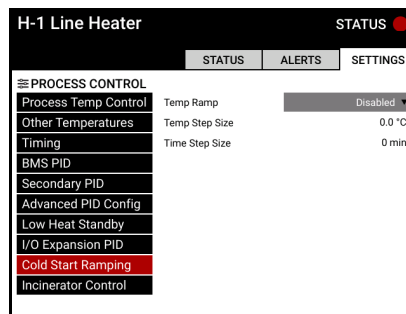

Setting	Default	Options	Description
Temp Ramp	Disabled	Disabled	Cold start ramping is not used.
		Enabled	Firing rate is modulated upon start up to attempt to maintain the rate of temperature increase specified by the step size settings below.
Temp Step Size	0 °C 0 °F	0 °C - 1350 °C 0 °F - 2430 °F	Specifies the maximum temperature increase allowed over a specified period upon start up.
Time Step Size	0 min	0 min – 65535 min	

16.10.1.10 INCINERATOR CONTROL

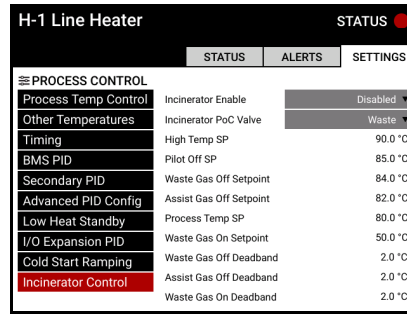

Setting	Default	Options	Description
Incinerator Enable	Disabled	Enabled	The appliance is an incinerator.
		Disabled	The appliance is not an incinerator.
Incinerator POC Valve	Waste	Waste	The POC input is connected to a proof of closure switch on the waste gas valve.
		Assist	The POC input is connected to a proof of closure switch on the assist gas valve.
High Temp SP	See Process Temp Control settings above		
Pilot Off SP			
Waste Gas Off Setpoint	84 °C 183.2 °F	0 °C - 1350 °C 32 °F - 2462 °F	Specifies the process temperature above which the waste gas valve is de-energized.
Assist Gas Off Setpoint	82 °C 179.6 °F	0 °C - 1350 °C 32 °F - 2462 °F	Specifies the process temperature above which the assist gas valve is de-energized.
Process Temp SP	See Process Temp Control settings above		
Waste Gas On Setpoint	50 °C 122 °F	0 °C - 1350 °C 32 °F - 2462 °F	Specifies the process temperature above which the waste gas valve is energized.
Waste Gas Off Deadband	2 °C 3.6 °F	0 °C - 100 °C 0 °F - 180 °F	Specifies the deadband applied to prevent fluctuation between states when the process temperature is near the setpoints.
Assist Gas Off Deadband	2 °C 3.6 °F	1 °C - 200 °C 1.8 °F - 360 °F	
Waste Gas On Deadband	2 °C 3.6 °F	2 °C - 2 °C 3.6 °F - 3.6 °F	

16.10.2 INPUTS

16.10.2.1 AUX IN CONTACT

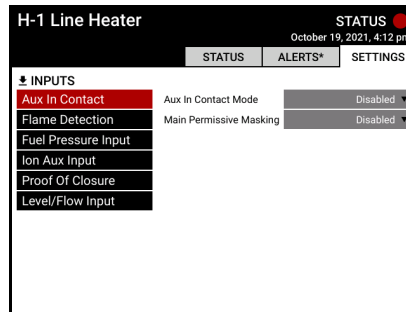

Setting	Default	Options	Description
Aux In Contact Mode	Disabled	Disabled	The Aux In contact is ignored.
		Proof of Low Fire	The Aux In contact is connected to a proof of low fire position switch on the temperature control valve or a proof of closure switch on the high fire valve.
		Proof of Closure 2	The Aux In contact is connected to a proof of closure switch.
		Proof of Pilot	The Aux In contact is connected to a proof of pilot position switch.
		Low Fuel Pressure	The Aux In contact is connected to a low fuel pressure switch. * Low fuel pressure alert behavior is dictated by the Low Fuel Pressure Restart and Restart Mode settings on the Pressure Settings Screen .
		Proof of Airflow	The Aux In contact is connected to a proof of airflow switch.
Main Permissive Masking	Disabled	Enabled	Waits listed below are ignored and removed from the Appliance Alerts Screen when a main permissive is present on the controller. Waits affected: <ul style="list-style-type: none"> - All I/O Expansion waits - Low Fuel Pressure - Low Fuel Pressure Dry Contact - Low Tank Level - Tank Level Contact Open
		Disabled	Input waits are not ignored.

16.10.2.2 FLAME DETECTION

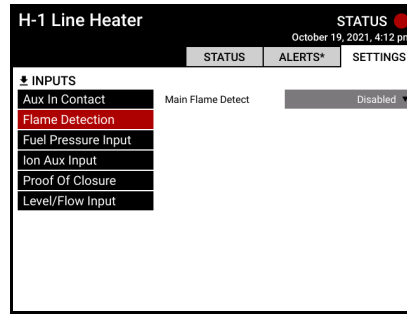

Setting	Default	Options	Description
Main Flame Detect	Disabled		Refer to Pilot Wizard Ignition Settings Tab section for configuration options and descriptions.

16.10.2.3 FUEL PRESSURE INPUT

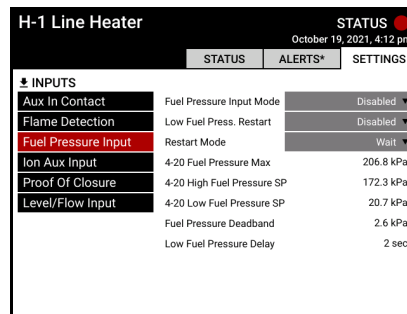

Setting	Default	Options	Description
Fuel Pressure Input Mode	Disabled	Disabled	The fuel pressure input is ignored.
		Dry Contact	The fuel pressure input is connected to a low-pressure switch and high-pressure switch in series (or a low-pressure switch if Low Pressure restart is not required).
		4-20	The fuel pressure input is connected to a 4-20mA transmitter.
		Dry Contact High Pressure	The fuel pressure input is connected to a high-pressure switch.
Low Fuel Press Restart	Disabled	Enabled	Low-pressure event ¹ behavior is dictated by Restart Mode setting.
		Disabled	A low-pressure event ¹ causes an alarm.
Restart Mode	Wait	Wait	A low-pressure event ¹ causes a wait.
		Main Permissive	A low-pressure event ¹ causes a main permissive.
4-20 Fuel Pressure Max	207 kPa 30 psi	Any	Specifies the maximum reading of the pressure transmitter.
4-20 High Fuel Pressure SP	172 kPa 25 psi	0 % - 100 % of Max	Specifies the transmitter reading above which the appliance shuts down on high pressure.
4-20 Low Fuel Pressure SP	20.7 kPa 3 psi	0 % - 100 % of Max	Specifies the transmitter reading below which the system registers a low-pressure event.
Fuel Pressure Deadband	2.6 kPa 0.4 psi	0 % - 6.25 % of Max	Specifies the deadband applied to prevent fluctuation between states.
Low Fuel Pressure Delay	2 s	2 s - 20 s	Specifies the time for which a low-pressure event ¹ must be present before the system acts.

¹ A low-pressure event is (1) a pressure input reading below its configured 4-20 Low Fuel Pressure SP when it is configured in 4-20 Mode, and (2) a de-energized [Auxiliary input](#) when it is configured in Low Fuel Pressure Mode.

16.10.2.4 ION AUX INPUT

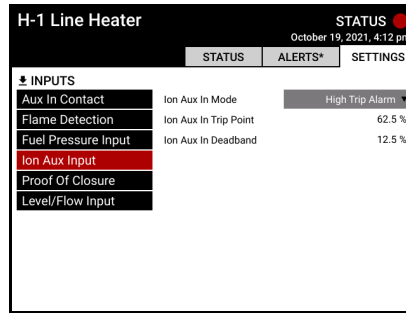

The Ion Aux Input is located on the Ion Pilot card and can be used for either (1) thermocouple flame detection (with a thermocouple to 4-20mA converter) or (2) to connect a generic 4-20mA transmitter for high trip shutdown. The [Ion Aux In Type setting](#) must be enabled in the Pilot Wizard for the following settings to take effect.

Setting	Default	Options	Description
Ion Aux In Mode	High Trip Alarm	TC Flame Detect	The Ion Aux input is used as a 4-20mA flame detection input and the trial for ignition time is increased from 10 to 120 seconds.
		High Trip Alarm	The Ion Aux input is connected to digital input device or a 4-20mA transmitter for shut down upon a high trip event.
Ion Aux In Trip Point	14 mA 62.5 %	4 mA - 20 mA 0 % - 100 %	Specifies the Ion Aux input reading above which the system shuts down.
Ion Aux In Deadband	6 mA 12.5 %	4 mA - 20 mA 0 % - 100 %	Specifies the deadband applied to prevent fluctuation between states.

16.10.2.5 PROOF OF CLOSURE

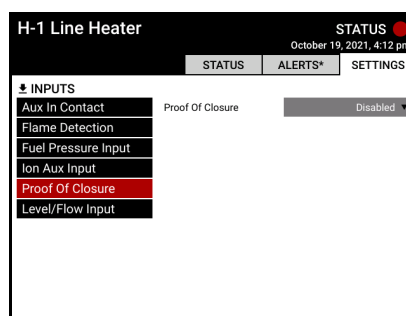

Setting	Default	Options	Description
Proof of Closure	Disabled	Enabled	The POC input is connected to a proof of closure switch on the main valves.
		Disabled	The proof of closure input is ignored.

16.10.2.6 LEVEL/FLOW INPUT

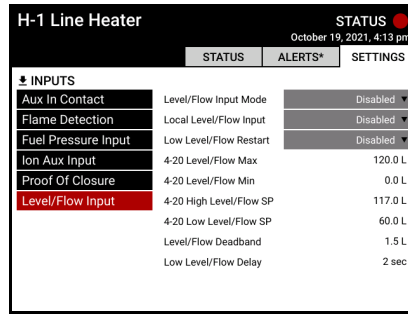

Setting	Default	Options	Description
Level/Flow Input Mode	Disabled	Disabled	The Level/Flow input is ignored.
		Dry Contact	The Level/Flow input is connected to a Level or Flow switch.
		4-20	The Level/Flow input is connected to 4-20mA Level or Flow transmitter.
Local Level/Flow Input	Disabled	Enabled	The Level/Flow input device is physically wired to the controller.
		Disabled	The Level/Flow input device is physically wired to a different controller in the appliance.
Low Level/Flow Restart	Disabled	Enabled	The system transitions into the Waiting state upon a low-level/flow event and does not proceed until cleared.
		Disabled	The appliance shuts down on low-level/flow events.
4-20 Level/Flow Max	120 L 31.7 gal	0 L - Any	The maximum reading of the level or flow transmitter.
4-20 Level/Flow Min	0 L 0 gal	0 L - Any	The minimum reading of the level or flow transmitter.
4-20 High Level/Flow SP	117 L 31 gal	0 % - 100 % of Max	Specifies the transmitter reading above which the appliance shuts down on high level/flow.
4-20 Low Level/Flow SP	60 L 15.9 gal	0 % - 100 % of Max	Specifies the transmitter reading below which the system registers a low level/flow event.
Level/Flow Deadband	1.5 L 0.4 gal	0 % - 6.25 % of Max	Specifies the deadband applied to prevent fluctuation between states.
Low Level/Flow Delay	2 s	2 s - 20 s	Specifies the time for which a low-level/flow event must be present before the system acts.

16.10.3 OUTPUTS

16.10.3.1 4-20 AUX OUT

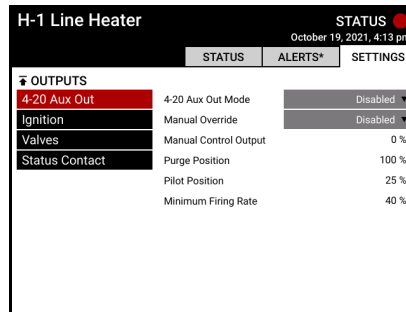

Setting	Default	Options	Description
4-20 Aux Out Mode	Disabled	Disabled	The Aux output is disabled
		Manual	The Aux output delivers a 4-20mA signal in accordance with the configured Manual Control Output setting below.
		Temp Echo	The Aux output delivers a percentage value of the process temperature in relation to the High Temp Setpoint , mapped as a 4-20mA signal. Example: High Temp SP setting = 100 ° Process temperature reading = 50 ° Aux output in % = $(50°/100°) \times 100 = 50\%$ Aux output in mA = 12mA
		Pressure Echo	The Aux output delivers a 4-20mA signal identical to the 4-20mA Pressure input signal.
		Level Echo	The Aux output delivers a 4-20mA signal identical to the 4-20mA Level/Flow input signal.
		PID Control	The Aux output delivers a 4-20mA signal in accordance with configured Position settings and the internal PID control algorithm
		Appliance Firing Rate	The Aux output delivers a 4-20mA signal in accordance with configured Position setting and a 4-20mA I/O Expansion card firing rate input.
Manual Override	Disabled	Enabled	The Aux output delivers a 4-20mA signal in accordance with the configured Manual Control Output setting below.
		Disabled	The Manual Control Output setting below is ignored.
Manual Control Output	0 %	0 % - 100 %	Specifies the Aux output signal when 4-20 Aux Out Mode setting is set to Manual or when the Manual Override setting is set to Enabled.
Purge Position	100 %	0 % - 100 %	Specifies the Aux output signal when requesting purge position. Applicable when 4-20 Aux Out Mode setting is set to BMS PID.
Pilot Position	25 %	0 % - 100 %	Specifies the Aux output signal when requesting pilot position. Applicable when 4-20 Aux Out Mode setting is set to BMS PID.
Minimum Firing Rate	40 %	0 % - 70 %	Specifies the minimum allowable Aux output signal when in a main state. Applicable when 4-20 Aux Out Mode setting is set to BMS PID.

16.10.3.2 IGNITION

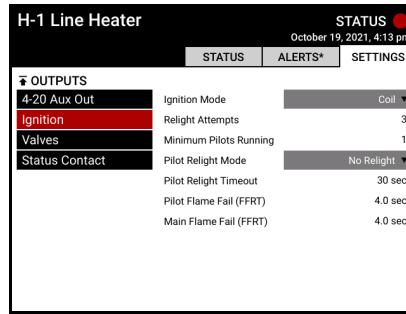

Setting	Default	Options	Description
Ignition Mode	Coil	Refer to Pilot Wizard Ignition Settings Tab section for configuration options and descriptions.	
Relight Attempts	3 attempts		
Minimum Pilots Running	1		
Pilot Relight Mode	During Flame Fail		
Pilot Relight Timeout	30 s		
Pilot Flame Fail (FFRT)	4 s		
Main Flame Fail (FFRT)	4 s		

16.10.3.3 VALVES

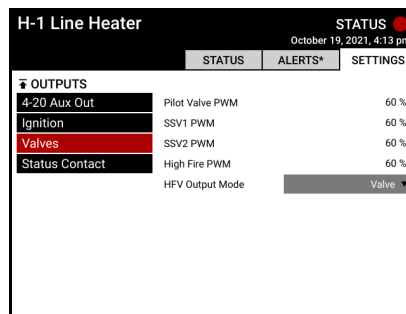

Setting	Default	Options	Description
Pilot Valve PWM	60 %	20 % - 100 %	Specifies the duty cycle of the BMS Controller Pilot valve output and the Ion Pilot card Valve output.
SSV1 PWM	60 %	20 % - 100 %	Specifies the duty cycle of the SSV1 valve output.
SSV2 PWM	60 %	20 % - 100 %	Specifies the duty cycle of the SSV2 valve output.
High Fire PWM	60 %	20 % - 100 %	Specifies the duty cycle of the HFV valve output.
HFV Output Mode	Valve	Valve	The HFV output is connected to a normally closed high fire valve.
		Forced Draft Fan	The HFV output is connected to a relay enabling a forced draft fan.
		Purge Fan	The HFV output is connected to a relay enabling a purge fan.

16.10.3.4 STATUS CONTACT

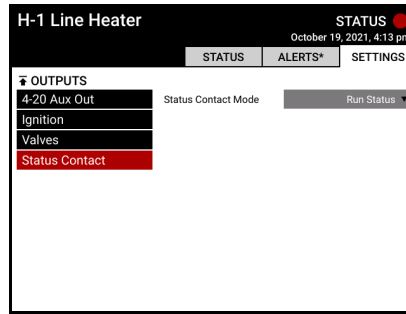

Setting	Default	Options	Description
Status Contact Mode	Run Status		Refer to Status Contact Behavior section for configuration options and system behavior.

16.10.4 SETUP

16.10.4.1 COMMISSIONING

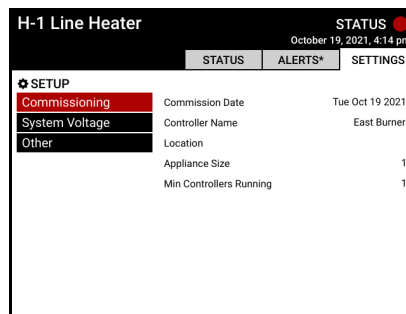

Setting	Default	Options	Description
Commission Date	-	Any	Specifies the date that the system was commissioned.
Controller Name	Not Set	Any	Specifies the controller names as configured above in the Appliance Wizard .
Location	Not Set	Any	Specifies the controller location.
Appliance Size	1 controller	Read Only 1 – 16 controllers	Displays the number of controllers in the appliance.
Min Controllers Running	1 controller	1 – 16 controllers	Specifies the number of controllers that must be running for the appliance to remain running. * Cannot be set higher than the Appliance Size for multi-burner applications.

16.10.4.2 SYSTEM VOLTAGE

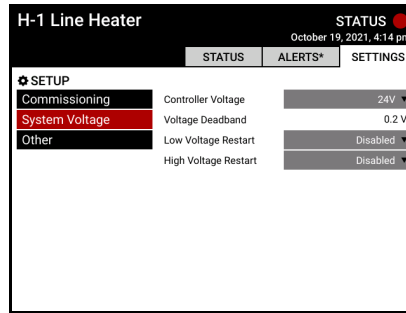

Setting	Default	Options	Description
Controller Voltage	24 V	12 V	The controller is supplied by a 12 V power source.
		24 V	The controller is supplied by a 24 V power source.
Voltage Deadband	0.2 V	0 V - 0.5 V	Specifies the deadband applied to the input voltage to prevent fluctuation between states when the reading is near the trip points.
Low Voltage Restart	Disabled	Enabled	The system automatically restarts following a power loss while running.
		Disabled	The system does not automatically restart following a power loss event.
High Voltage Restart	Disabled	Enabled	The system transitions to the Waiting state upon a high voltage event.
		Disabled	The system shuts down upon a high voltage event.

16.10.4.3 OTHER

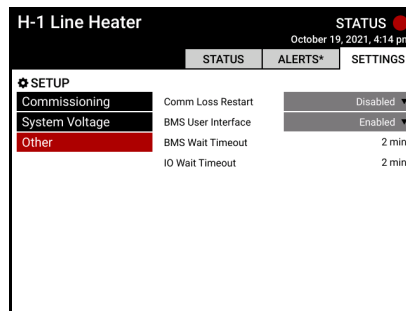

Setting	Default	Options	Description
Comm Loss Restart	Disabled	Enabled	The system goes to the Waiting state upon Pilot card communication loss.
		Disabled	The system goes to Lockout upon Pilot card communication loss.
BMS User Interface	Enabled	Enabled	BMS Enclosure LED indicators enabled.
		Disabled	BMS Enclosure LED indicators disabled.
BMS Wait Timeout	2 min	0 min	BMS Wait Timeout setting is ignored.
		1 - 120 min	Specifies the time after which a BMS wait becomes an alarm. Applicable waits: BMS Low Voltage • BMS High Voltage • BMS Low Fuel Pressure (4-20mA and Dry contact mode) • BMS Low Level/Flow • BMS Level/Flow Open • Loss of Communications
IO Wait Timeout	2 min	0 min	IO Wait Timeout setting is ignored.
		1 - 120 min	Specifies the time after which an I/O Expansion wait becomes an alarm. Applicable waits: I/O Expansion Input Invalid • I/O Expansion Input Low Trip • I/O Expansion Input High Trip • I/O Expansion Input Open

16.10.5 CALIBRATION

16.10.5.1 BMS

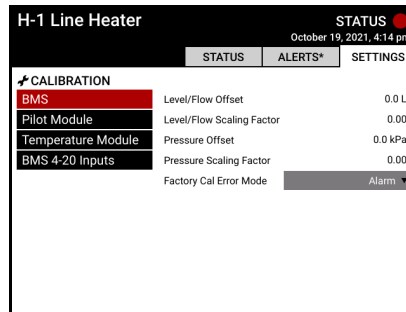

Setting	Default	Options	Description
Level/Flow Offset	0 mA	-3.2 mA – 3.2 mA	Specifies the offset applied to the BMS Level/Flow input readings.
Level/Flow Scaling Factor	0.00	Read Only	
Pressure Offset	0 mA	-3.2 mA – 3.2 mA	Specifies the offset applied to the BMS Pressure input readings.
Pressure Scaling Factor	0.00	Read Only	
Factory Cal Error Mode	Alarm	Alarm	Calibration errors prevent the system from starting.
		Warning	Calibration errors are displayed as warnings, but do not otherwise affect system behavior.
		Suppress	Calibration errors are ignored.

16.10.5.2 PILOT MODULE

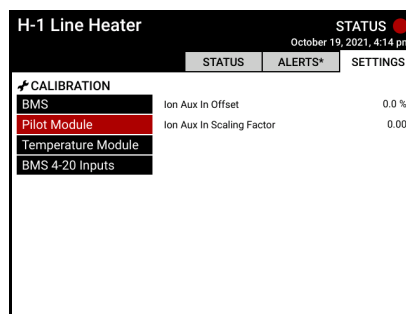

Setting	Default	Options	Description
Ion Aux In Offset	0.0 %	-20 % - 20 %	Specifies the offset applied to the Ion Pilot card Aux input readings.
Ion Aux In Scaling Factor	0.00	Read Only	

16.10.5.3 TEMPERATURE MODULE

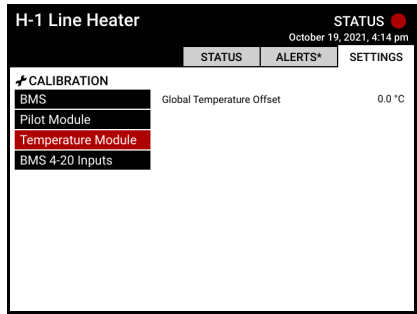

Setting	Default	Options	Description
Global Temperature Offset	0.0 °C 0.0 °F	-50 °C - 50 °C -90 °F - 90 °F	Specifies the offset applied to the temperature card inputs.

16.10.5.4 BMS 4-20 INPUTS

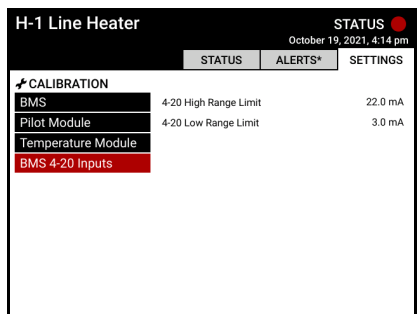

Setting	Default	Options	Description
4-20 High Range Limit	22.0 mA	19 mA - 22 mA	Specifies the trip points for the 4-20mA out of range alarms.
4-20 Low Range Limit	3.0 mA	3 mA - 5 mA	

16.11 FARC TUNING SETTINGS

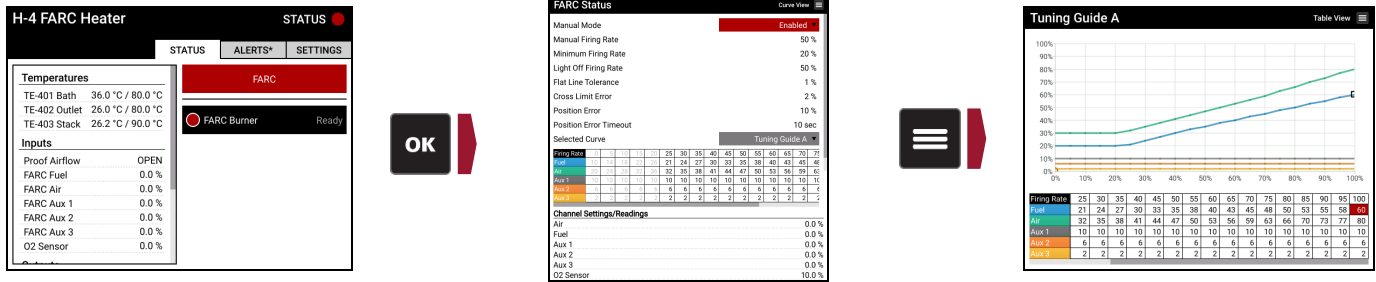

60. Configure all FARC settings in accordance with manufacturer specifications and safety design documentation. Manual Mode must be Enabled to make changes to the table. Refer to the [PF3100 FARC User Guide](#) for detailed configuration instructions.

Setting	Options	Description
Manual Mode	Enabled	When in the Process Control state, the system sets the firing rate to match the configured Manual Firing Rate setting and moves all channel outputs to their corresponding positions from the active FARC table.
	Disabled	The system ignores the Manual Firing Rate setting below.
Manual Firing Rate	0 - 100%	Specifies the firing rate of the system when the Manual Mode setting is set to Enabled.
Selected Curve	Curve A	Specifies that configuration changes made from this menu apply to FARC Curve A
	Curve B	Specifies that configuration changes made from this menu apply to FARC Curve B
Fuel-Air Ratio Table Firing Rate	Not adjustable – fixed 5% increments	Specifies the firing rate to which all values in the column apply
Fuel-Air Ratio Table - Air	0 – 100%	Specifies the air actuator position for a given firing rate.
Fuel-Air Ratio Table - Fuel	0 – 100%	Specifies the fuel actuator position for a given firing rate.
Fuel-Air Ratio Table – Aux Channels	0 – 100%	Specifies the auxiliary channel actuator position for a given firing rate.

16.12 O₂ TRIM TUNING

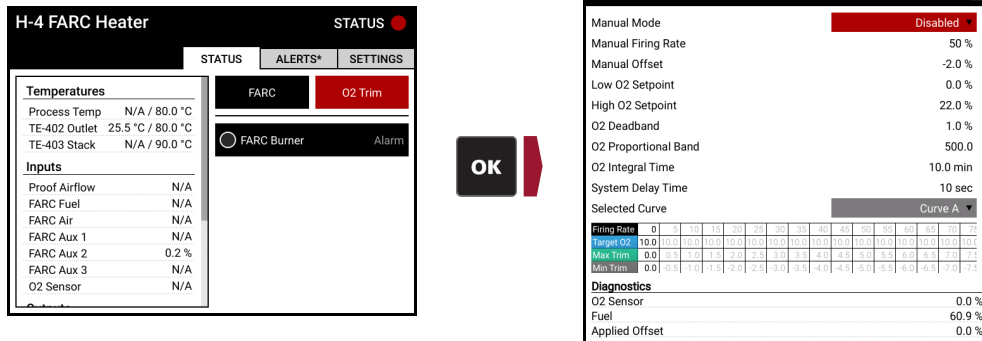

61. Configure all O₂ Trim settings in accordance with manufacturer specifications and safety design documentation. Manual Mode must be Enabled to make changes to the table. Refer to the [PF3100 FARC User Guide](#) for detailed configuration instructions.

Setting	Options	Description
Manual Mode	Enabled	When in the Process Control state, the system sets the firing rate and offset to match the configured Manual Firing Rate setting and Manual Offset setting, respectively, and moves all channel outputs to their corresponding positions from the active FARC table.
	Disabled	The system ignores the Manual Firing Rate and Manual Offset settings below.
Manual Firing Rate	0 - 100%	Specifies the firing rate of the system when the Manual Mode setting is set to Enabled.
Manual Offset	-100% - +100%	Specifies the O ₂ Trim offset when the Manual Mode setting is set to Enabled.
O ₂ Proportional Band	Refer to FARC/O₂ Trim Wizard O₂ Trim Tab above for configuration options and descriptions.	
O ₂ Integral Time		
Selected Curve	Curve A	Specifies that configuration changes made from this menu apply to FARC Curve A
	Curve B	Specifies that configuration changes made from this menu apply to FARC Curve B
O ₂ Trim Table Firing Rate	Not adjustable – fixed 5% increments	Specifies the firing rate to which all values in the column apply
O ₂ Trim Table – Target O ₂	0 – 22%	Specifies the desired O ₂ concentration for a given firing rate.
O ₂ Trim Table – Max Trim	0% - +100%	Specifies the desired maximum offset applied for a given firing rate.

O ₂ Trim Table – Min Trim	-100% – 0%	Specifies the desired minimum offset applied for a given firing rate.
--------------------------------------	------------	---

16.13 TEST SYSTEM

All settings changes must be verified against the safety design documentation and equipment manufacturer specifications prior to starting the system. All safety functions must be validated to ensure that the system behaves as required in all safety shut down situations.

- 62. Ensure that all safety settings are configured in accordance with safety design documentation and equipment manufacturer specifications.
- 63. Test all safety functions to ensure that the system has been configured correctly.

16.14 SAVE SETTINGS

Once commissioning is complete, settings should be backed up to a USB storage device. Saved settings can be restored on the system or used to commission a separate system (in conjunction with the [Swap Wizard](#)) identically.

- 64. Use the [Settings Backup tool](#) to save settings to a USB storage device.

17 SYSTEM OPERATION

The following sections outline the procedures required for basic operation of a commissioned PF3100 system including starting and stopping controllers or appliances, finding status and alert information, making quick setpoint adjustments and acknowledging lockout messages.

17.1 STARTING THE SYSTEM

Controllers and appliances can be started (from the Ready state only) using the methods outlined below:

Start individual controllers:

- User Interface – Navigate to desired controller status screen, press **START**, select “This Controller”, then press **OK**.

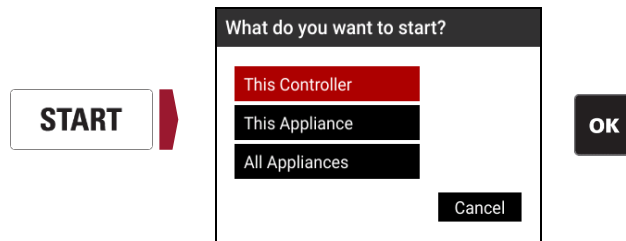

- External Ignition Switch (If installed and enabled) – Turn switch to ignite position and hold for 1 second.
- Remote start input – From the Ready state, toggle input from energized to de-energized to energized within 30 seconds.
- Modbus – Write start command to the Start/Stop Modbus register (30100/40100). Refer to [PF3107-00 Modbus Register Map](#) for details.

Start individual appliance:

- User Interface – Navigate to desired appliance status screen, press **START**, select “This Appliance”, then press **OK**.

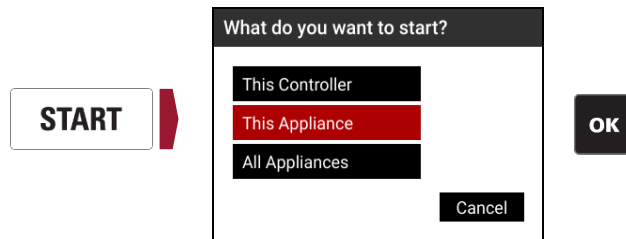

Start all appliances:

- User Interface – Press **START** from any screen, select “All Appliances”, then press **OK**.

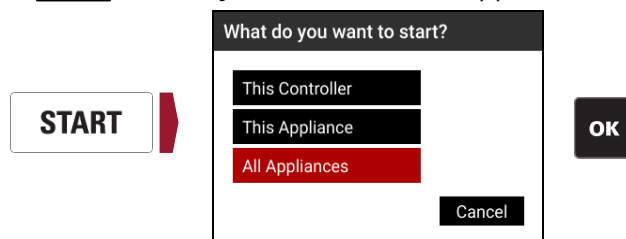

17.2 ACCESSING SYSTEM STATUS INFORMATION

17.2.1 REAL-TIME STATUS INFORMATION

Useful status information is displayed on the Appliance Status Screen and Controller Status Screen. Advanced status information can be found on the Flame Diagnostics Screen and System Data Screen. The information available includes but is not limited to:

- Controller state information
- Input readings
- Output status
- Flame quality

17.2.2 ALERT ANNUNCIATION

All alerts are annunciated on the Alerts Screen while active and can be found in the Event Log after they have been cleared. The alert types are as follows:

- Alarm – Prevents the controller from entering any running state.
- Wait – Prevents the controller from entering any fuel state.
- Main Permissive – Prevents the controller from entering any main fuel state.
- Warning – Provides information to the user but does not affect system behavior.

Refer to the [Alert Codes](#) section for descriptions of each alert.

17.3 ADJUSTING SETPOINTS

The Quick Adjust Dialog can be accessed, while the appliance is running, from the Appliance Status Screen by pressing and entering a valid password. and can then be used to incrementally adjust the configured Process Setpoint, Low Fire Setpoint and Pilot Off Setpoint for the appliance. Additional settings and configuration wizards cannot be accessed while the appliance is running and must be modified by capable personnel only.

17.4 ADJUSTING INPUT AND OUTPUT SETTINGS

Configurable inputs and outputs can be adjusted from the Appliance Status screen by selecting the desired item and pressing to bring up a configuration dialog. Use the keypad to adjust the settings as desired. The displayed settings are dependent on the security level of the password used to access the menu.

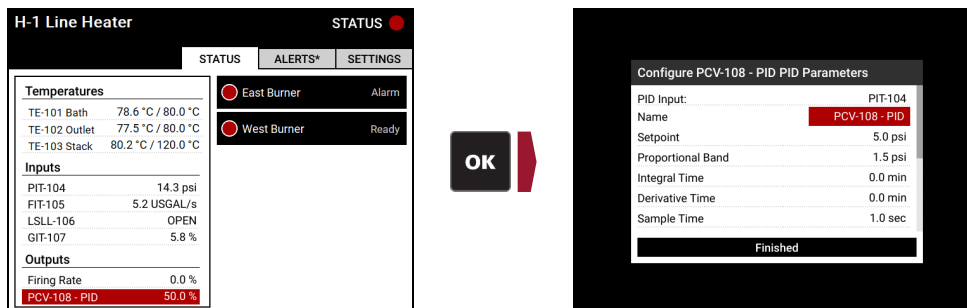

17.5 STOPPING THE SYSTEM

Controllers and appliances can be stopped using the methods outlined below:

Stop individual controllers:

Safety-Rated Stopping Methods:

- External Ignition Switch (If installed and enabled) – Turn switch to stop position.
- ESD input – Toggle input to de-energized position.

Non-Safety-Rated Stopping Methods:

- Modbus – Write stop command to the Start/Stop Modbus register (30100/40100). Refer to [PF3107-00 Modbus Register Map](#) for details.
- User Interface – Navigate to desired controller status screen, press **STOP**, select “This Controller”, then press **OK**.

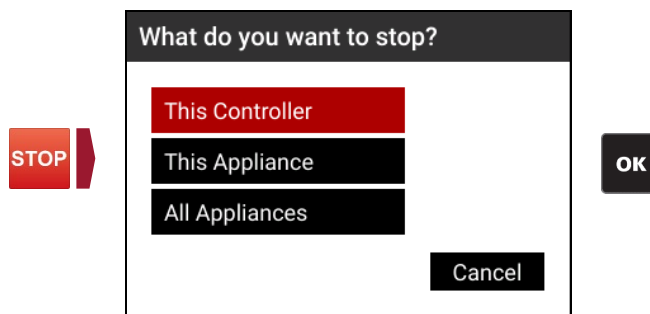

Stop individual appliance:

- User Interface – Navigate to desired appliance status screen, press **STOP**, select “This Appliance”, then press **OK**.

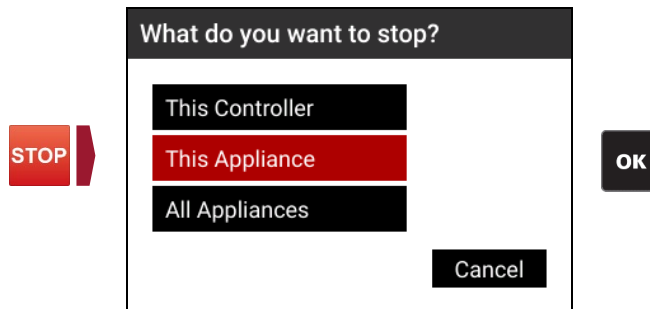

Stop all appliances:

- User Interface – From any screen, press **STOP**, select “All Appliances”, then press **OK**.

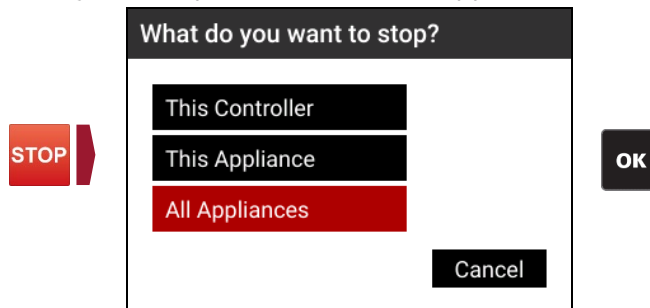

17.6 REIGNITING A LOST PILOT

Lost pilots can be re-ignited without stopping the controller for multi-pilot applications where one or more pilot flames are lost and the Minimum Pilots Running setting is still satisfied. From the Controller Status Screen, select the lost pilot and press **OK** to attempt pilot reignition while maintaining the current controller state.



17.7 ACKNOWLEDGING LOCKOUTS

Lockout messages appear when a controller enters the Lockout state and must be acknowledged for the controller to transition to any other state. The following methods can be used to acknowledge and clear a lockout message from the screen:

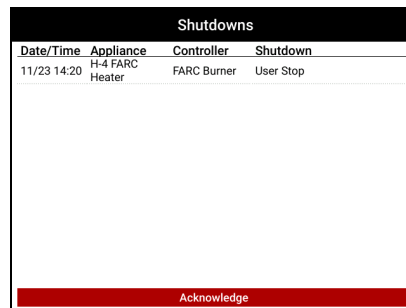

- User Interface: Press **OK**.
- External Ignition Switch: Toggle switch from Run to Stop to Run position within 30 seconds.
- Remote Start input: Toggle input from energized to de-energized to energized within 30 seconds.
- Modbus – Write Acknowledge command to the Clear Shutdown Code Modbus register (30143/40143). Refer to [PF3107-00 Modbus Register Map](#) for details.

17.8 ADVANCED PF3100 SOFTWARE FEATURES

17.8.1 PID CONTROL

Below is a brief overview of the PID control features available on the PF3100. Refer to [PID Tuning Guide](#) document for additional details and configuration information. The following terms are used to describe the system behavior in the various PID control modes:

- Primary Process Temperature: The main process temperature as specified in the Temperature Wizard Create Inputs Tab.
- Secondary PID Input: An auxiliary process temperature as specified in the Temperature Wizard Create Inputs Tab or a Secondary PID Input as configured in the I/O Expansion Wizard Add Inputs Tab.
- Temperature Control Valve (TCV): A device installed in the main fuel train that restricts gas flow proportionally in accordance with a 4-20mA input from the BMS controller. This device must be wired to the BMS Aux output terminals.

17.8.1.1 BASIC PID CONTROL

In basic PID control applications, the TCV is controlled in accordance with the configured BMS PID settings to attempt to maintain the Primary Process Temperature at its configured Process Setpoint.

17.8.1.2 CASCADED PID CONTROL

In Cascaded PID control applications, the TCV is controlled and the Primary Process Setpoint is adjusted, both in accordance with the configured BMS PID settings, Secondary PID settings, and Advanced PID settings to attempt to maintain stability of a lagging Secondary PID Input at its configured Setpoint.

Example - Consider a line heater application where a stable outlet temperature is desired. The TCV directly controls fuel flow to the main burners heating the Bath which in turn heats the Outlet process fluid.

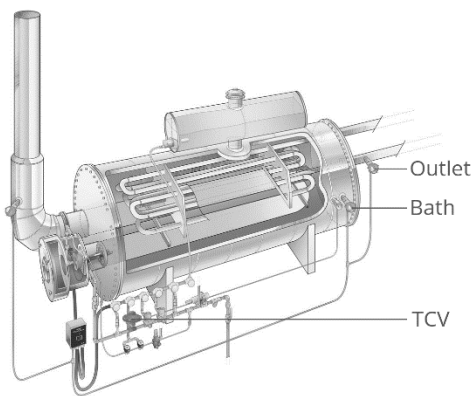

PID Input	Name	Process Setpoint	Setpoint Max setting	Setpoint Min setting	PID Parameters
Primary Process	Bath	400°F	380°F	420°F	As required per PID tuning
Secondary PID	Outlet	375°F	N/A	N/A	

In this example, the controller is free to change the Primary Process Setpoint between 380°F and 420°F, in accordance with the configured PID parameters, as required to attempt to maintain stability of the Outlet temperature. With basic PID control on the Outlet only, the Outlet temperature is achieved at the expense of Bath stability. With Cascaded PID control, the Outlet temperature can be achieved while maintaining Bath stability.

17.8.1.3 PID STAGING

PID Staging allows control based on either the Primary Process Temperature or the Secondary PID Input depending on a specific trigger condition. The controller modulates the TCV based on the configured Primary Process PID settings until the condition specified by the PID Staging Mode Setting is satisfied. At which point, the controller modulates the TCV based on the configured Secondary PID settings.

17.8.2 FUEL-AIR RATIO CONTROL (FARC)

The following section provides an overview of the PF3100 FARC capabilities. Refer to the [PF3100 FARC User Guide](#) for additional details and configuration instructions. A FARC system consists of a forced draft appliance with actuators controlling air flow and fuel flow and up to three additional actuators controlling other process inputs. The PF3100 allows specific actuator positions to be configured in 5% firing rate increments to control the fuel-air ratio of the combustion inputs across the entire operating range of the appliance.

17.8.2.1 BASIC FARC

A basic FARC application controls fuel and air channels only. Feedback signals from these actuators are monitored by the system to ensure that the fuel-air mixture is within the configured parameters.

17.8.2.2 MULTICHANNEL FARC

Up to three additional channels may be added for advanced FARC applications consisting of additional process inputs (e.g., flue gas recirculation, auxiliary fuel supply, etc.). Configuration options on the additional channels allow for flexibility in terms of position feedback and cross limiting requirements.

17.8.2.3 O₂ TRIM

The addition of a stack oxygen sensor allows for a FARC channel to be trimmed to achieve optimal efficiency while maintaining the configured fuel-air ratio within the configured parameters.

17.8.3 DEADBANDS

Deadbands are applied under certain conditions to avoid fluctuations between states when a process variable is close to its configured setpoint or trip point.

17.8.3.1 TEMPERATURE DEADBANDS

Temperature deadbands are applied to prevent valve chattering when a temperature reading is near a configured setpoint. Generally, the deadband is ignored on the transition from one state to another in one direction but is applied on the transition in the reverse direction (e.g., For a system configured for High Fire Valve control with Low Fire enabled (see image below), the deadband is ignored on the transition from Low Fire to Pilot (transition 4) but is applied on the subsequent transition back to Low Fire (transition 5). Similarly, the deadband is ignored at transition 3, but applied at transition 6).

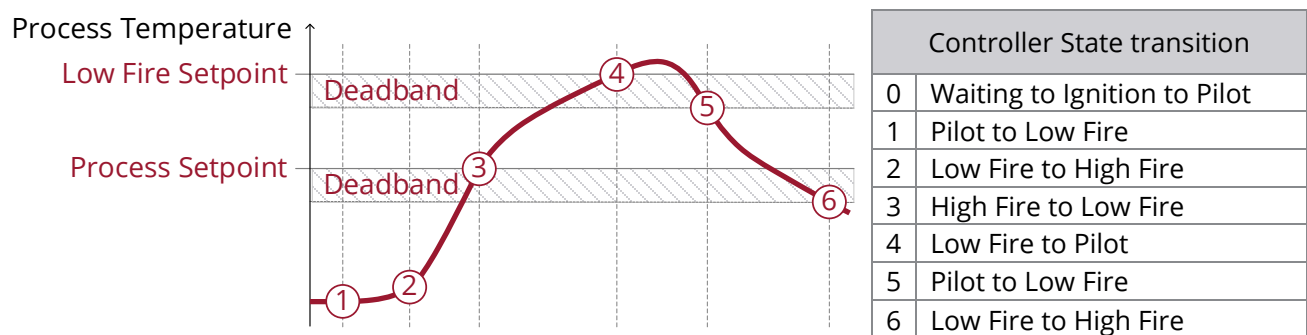

17.8.3.2 4-20mA INPUT DEADBANDS

4-20mA input deadbands are applied to both the High and Low Trip setpoints when clearing trip conditions only. The system registers a high trip event as soon as the input reading exceeds the configured High Trip setpoint and clears the event only after the input reading has dropped below the High Trip setpoint minus the deadband. Similarly, a low trip event is registered when the input reading drops below the configured Low Trip setpoint and clears the event only after the input reading has risen above the Low Trip setpoint plus the deadband.

18 SOFTWARE UTILITIES

The following section outlines the diagnostic, troubleshooting and upgrade tools available on all PF3100 systems.

18.1 QUICK START SETUP TOOL

The Quick Start Setup tool is accessible only when the system has no configured appliances. The tool guides the user through a firmware update and the Appliance, Temperature and Pilot Wizards to achieve basic system configuration. Refer to the [Commissioning](#) section above for additional commissioning details.

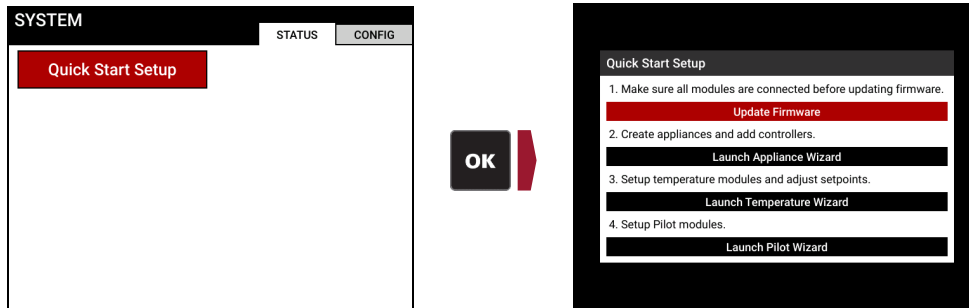

18.2 SWAP WIZARD

18.2.1 CONTROLLER SWAP

The Controller Swap tool is used to replace BMS controller cards in already-commissioned systems. A new controller is inserted into the system in place of the previous controller without the need to reconfigure all connected I/O modules or BMS settings.

1. Navigate to the Swap Wizard and select "Controller".

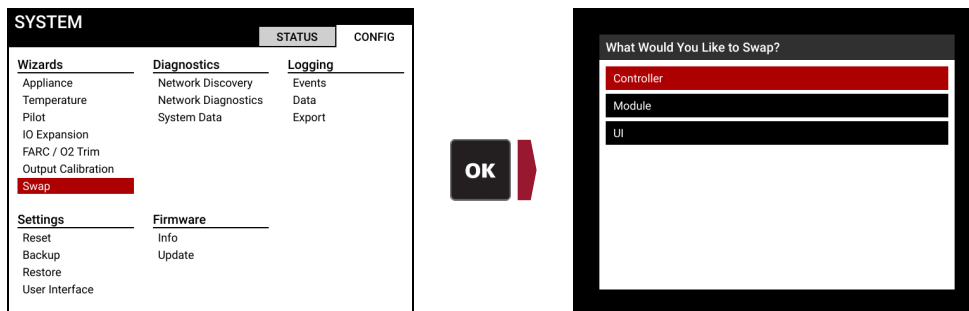

2. Choose a valid settings file to load, then select the originally commissioned controller on the Swap Modules tab and its replacement from the "Available Controllers" dialog.

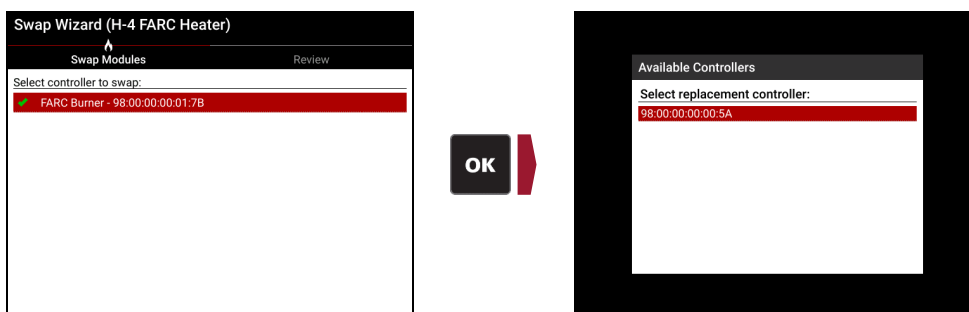

- Advance to the Review Tab and make note of any issues that will require additional commissioning (e.g., Calibration information does not transfer over to a replacement controller. Output calibration must be done separately for each controller using the Output Calibration Wizard), then select “Accept” to complete the swap.

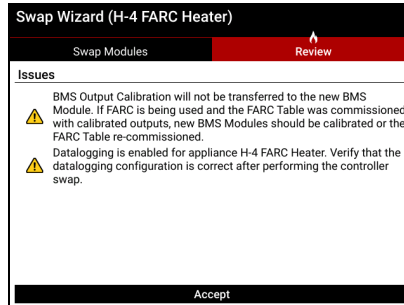

18.2.2 MODULE SWAP

The Module Swap tool allows I/O cards to be removed from the system and replaced without the need to reconfigure each module.

- Navigate to the Swap Wizard and select “Module”.

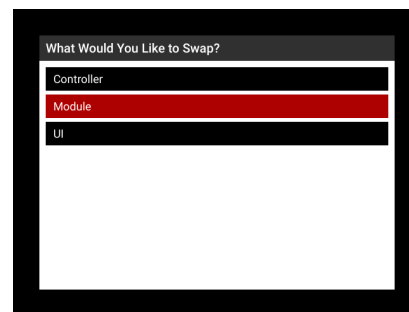
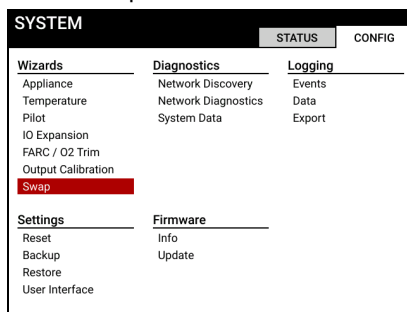

- The Swap Modules Tab lists all the non-communicating cards that are expected to be communicating with the system. Select a card and assign an appropriate replacement card.

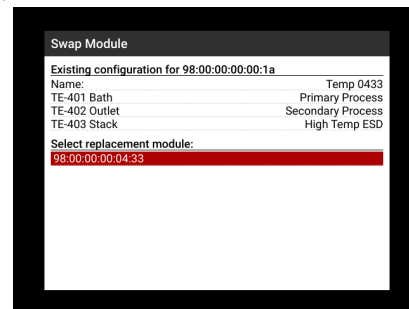
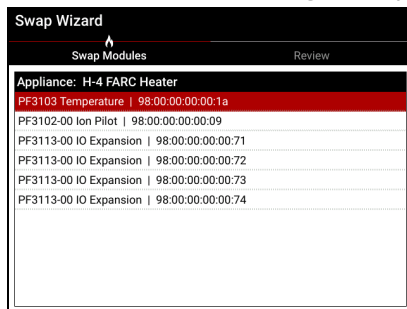

- Repeat previous step for all listed cards.

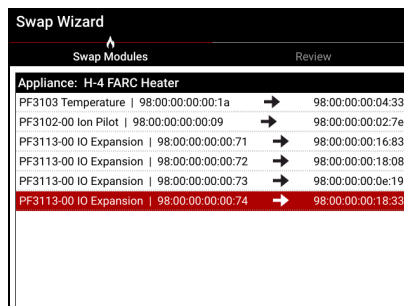

- Advance to the Review Tab and make note of any issues that will require additional commissioning (e.g., Calibration information does not transfer over to replacement I/O Expansion cards. Output calibration must be performed again for replacement I/O Expansion cards using the Output Calibration Wizard), then select “Accept” to complete the swap.

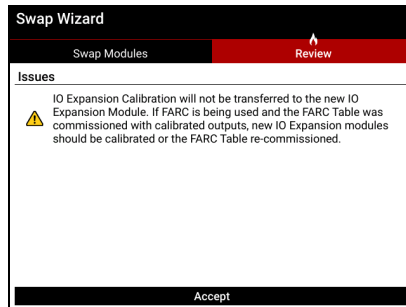

18.2.3 UI SWAP

The UI Swap tool allows the User Interface card to be removed from the system and replaced without the need to reconfigure the UI card settings.

- Navigate to the Swap Wizard and select “UI”.

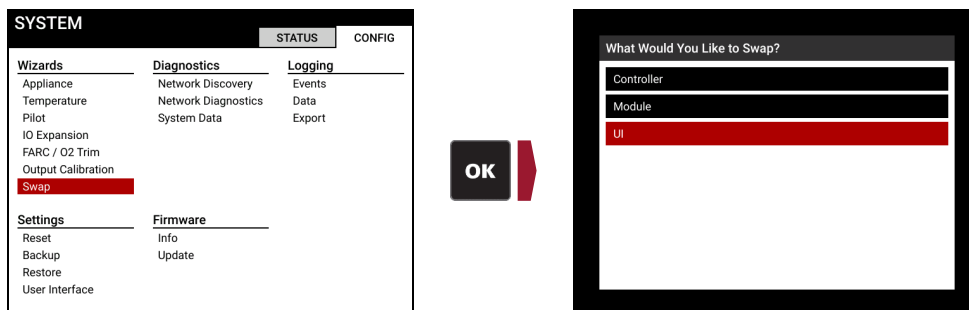

- Select a valid settings file, confirm the on-screen network map and select “Yes” to complete the swap.

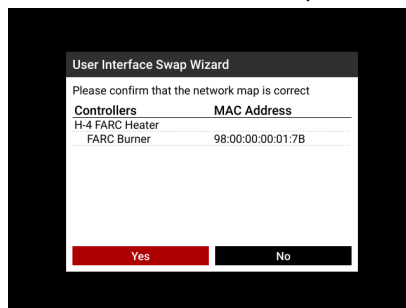

18.3 DIAGNOSTICS

18.3.1 NETWORK DISCOVERY

The Network Discovery tool is a communication diagnostic utility used to verify that each card in a system is connected, assigned and running the correct version of firmware. Connection issues can help identify PFRN wiring or firmware mismatch problems and assignment issues can help identify configuration or installation errors.

Module	MAC Address	Firmware Status
Appliance: H-1 Line Heater		
BMS: East Burner	98:00:00:01:7B	43.0 Connected
Temp 0433	98:00:00:04:33	43.0 Connected
Pilot 027E	98:00:00:02:7E	43.0 Connected
IO Exp 1683	98:00:00:16:83	43.0 Connected
IO Exp 1808	98:00:00:18:08	43.0 Connected
IO Exp 0E19	98:00:00:0E:19	43.0 Connected
IO Exp 1833	98:00:00:18:33	43.0 Connected

18.3.2 NETWORK DIAGNOSTICS

Module	MAC Address	Lost	PER
▼ H-4 FARC Heater			
▼ UI	98:00:00:01:248		
FARC Burner	98:00:00:01:7B	2	0.015 %
▼ FARC Burner	98:00:00:01:7B		
Temp 0433	98:00:00:04:33	0	0.000 %
Pilot 027E	98:00:00:02:7E	3	0.021 %
IO Exp 1683	98:00:00:16:83	0	0.000 %
IO Exp 1808	98:00:00:18:08	0	0.000 %
IO Exp Module	98:00:00:0E:19		Comm Loss

The Network Diagnostics tool displays the number of lost communication packets and the packet error rate for each connected card in the system since the last reset (with the “Reset” button at the top of the screen) or power cycle. This information is useful when troubleshooting communication issues.

18.3.3 SYSTEM DATA

Setting	Value
Status Contact	
Run Status	OPEN
420 Aux Out	0 %
Disabled	0 %
Input Contacts	
Start	CLOSED
ESD	CLOSED
POC	Disabled
AUX In	Disabled
Level	N/A
Pressure	N/A
Valve States	
Pilot Valve	Deenergized
SSV1	Deenergized
SSV2	Deenergized
High Fire Valve	Deenergized

The System Data Screen displays raw input and output data for the inputs and outputs of every connected card. This screen is useful for troubleshooting.

18.4 LOGGING

18.4.1 EVENT LOGGING

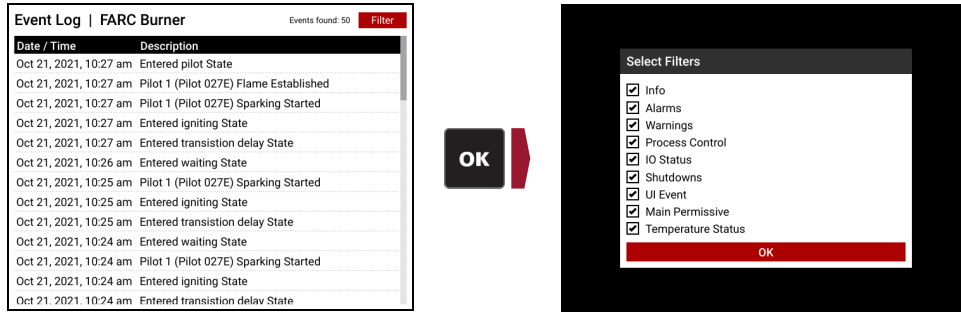

The Event Logging tool provides a detailed list of events for each BMS Controller card in a system. The list logs shutdowns, state transitions, present and cleared alerts, settings changes, input and output state changes and firmware updates. The Event Log can be exported to a USB storage device by using the [Export Tool](#) and is useful to have on hand when [Contacting Profire](#) for troubleshooting support.

18.4.2 DATA LOGGING

The Data Logging tool provides the ability to log and graph configured input and output readings. Data is logged in configurable intervals and can be displayed in a chart on-screen or exported to a USB storage device by using the [Export Tool](#).

18.4.2.1 DATA LOGGING SETUP

1. Navigate to the Data Logging tool and press **OK**, select desired appliance, then select "Configure".

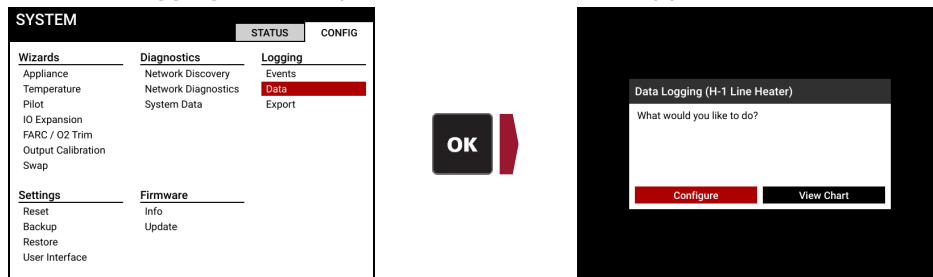

2. Specify the logging interval for each listed input and output and select "Finished"

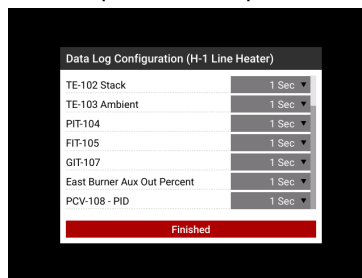

18.4.2.2 DATA CHARTING

1. Navigate to the Data Logging tool and press **OK**, select desired appliance, then select "View Chart".

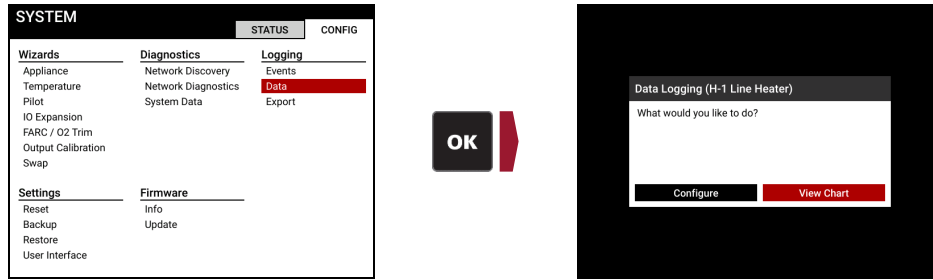

2. Specify the start date and time, the display scale and whether to update the chart with real-time data, then select "OK".

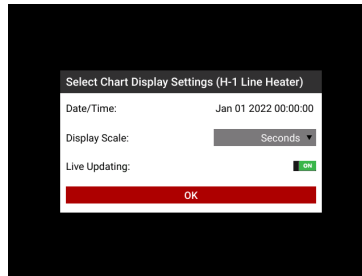

3. Select the inputs/outputs to display and select "Finished".

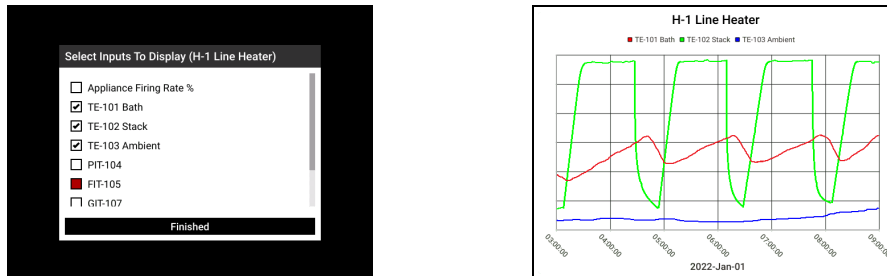

18.4.3 EXPORT TOOL

The Export tool saves Event Log and/or Data Log data to a USB storage device. Navigate to the Export tool and press **OK**, then follow the on-screen instructions to save desired information to the connected USB drive.

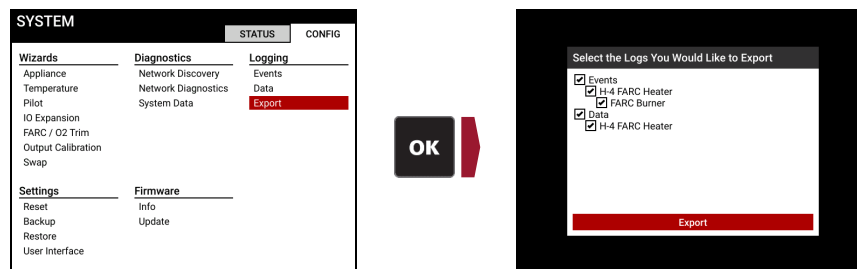

18.5 SETTINGS

18.5.1 RESET TO DEFAULTS

The Settings Reset utility is used to reset all system settings to their respective default values. Navigate to the Settings Reset tool and follow the on-screen instructions to select the appliances/controllers to be reset.

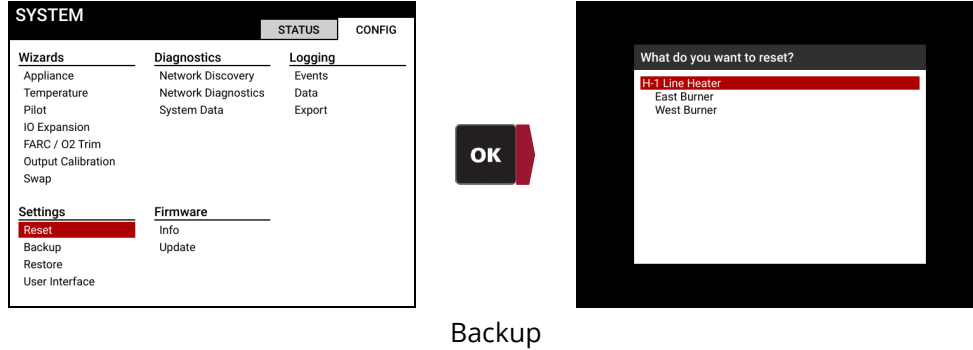

Backup

The Settings Backup utility is used to save system settings to a USB storage device. It is good practice to use this tool after a system has been fully commissioned.

18.5.1.1 SETTINGS BACKUP PROCEDURE

4. Insert a USB storage device into the USB port on the PF3100-00 User Interface card.
5. Navigate to the Settings Backup tool and press **OK**, then select the settings to be saved.

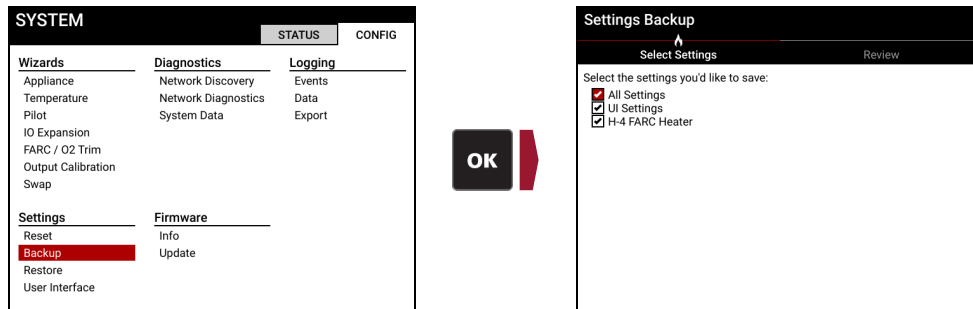

6. Select "Accept" from the Review Tab and name the settings file as desired.

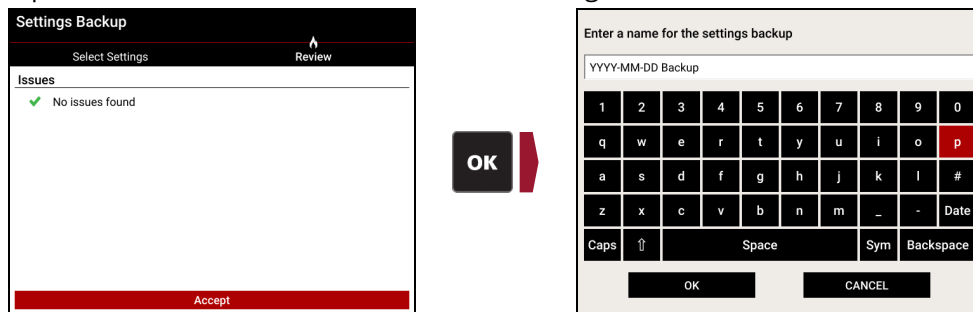

18.5.2 RESTORE

The Settings Restore utility is used to load system settings from a USB storage device. This is useful for situations requiring a BMS Controller replacement or commissioning of a system that has identical configuration requirements as one that is already commissioned.

18.5.2.1 SETTINGS RESTORE PROCEDURE

1. Insert USB drive containing desired settings file into the USB port on the PF3100-00 User Interface card.
2. Navigate to the Settings Restore tool and press **OK**.
3. Select desired settings file from the USB device or local UI storage.

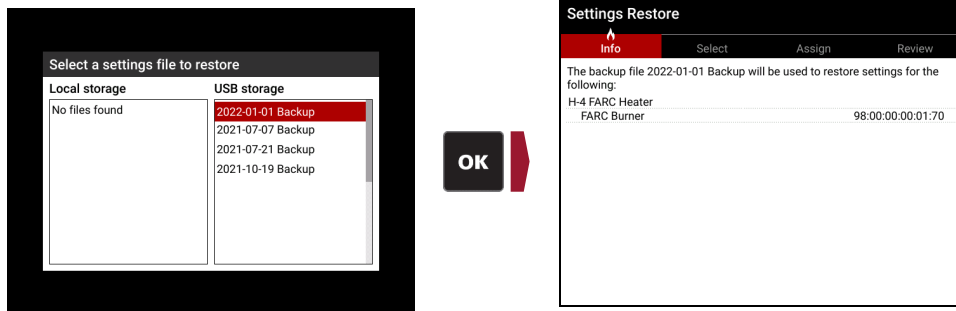

4. On the Select Tab, choose whether to restore (1) the UI settings only, (2) the controller settings only, or (3) all the settings.

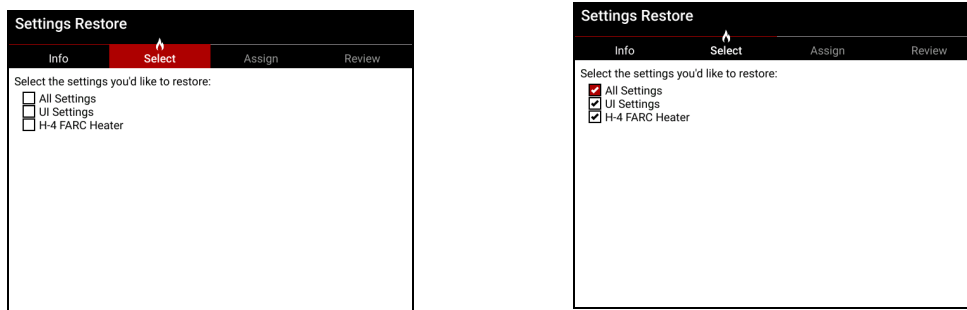

5. On the Assign Tab, select the controller to which the settings are to be restored.

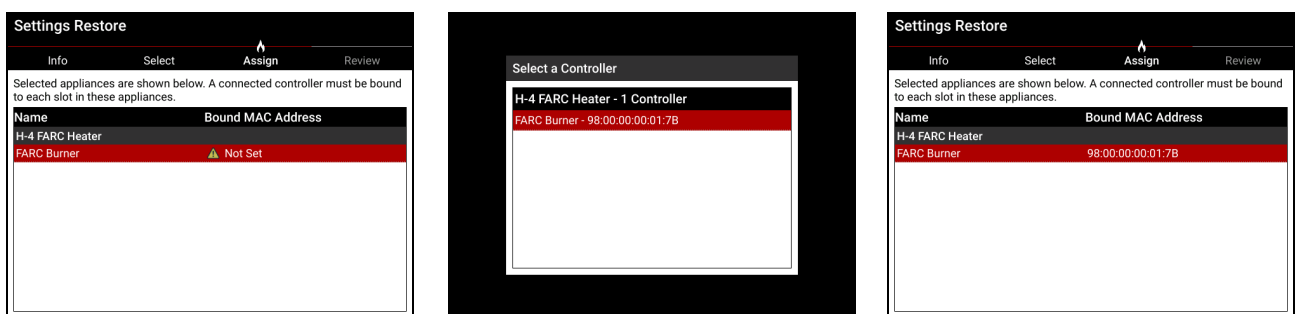

6. Proceed to the Review Tab and select "Accept" to confirm the restore.
7. Review the Results, and check/recommission any settings that were not restored successfully (e.g., If a settings file from a controller is restored on another controller, the calibration settings will not be restored to the new controller – output calibration must be re-performed through the Output Calibration Wizard following the restore).

18.6 FIRMWARE

18.6.1 INFO

The Firmware Info Screen provides important firmware and hardware information for the User Interface card only. For other connected cards, refer to the Network Discovery tool above.

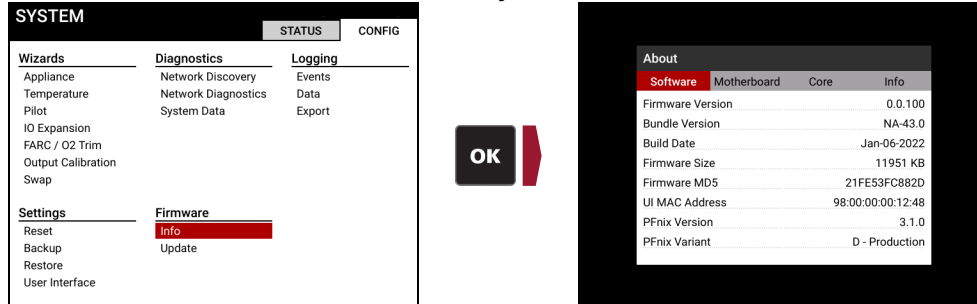

18.6.2 FIRMWARE UPDATE

The Firmware Update tool allows for all PF3100 cards to be field upgraded with an update file saved to a USB drive.

18.6.2.1 FIRMWARE UPDATE PROCEDURE

1. Download the desired firmware version from the [Profire Firmware Update Website](#) and save it to a USB storage device.
2. Insert USB storage device into the USB port on the PF3100-00 User Interface card.
3. Navigate to the [Settings Backup](#) tool and save all settings to the USB storage device.
4. Navigate to the Firmware Update tool and press **OK**, then select the firmware file to be installed

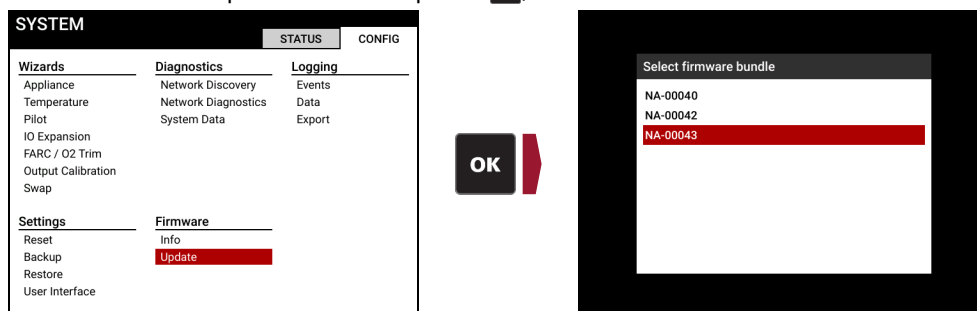

5. Ensure that all connected cards are displayed on screen.

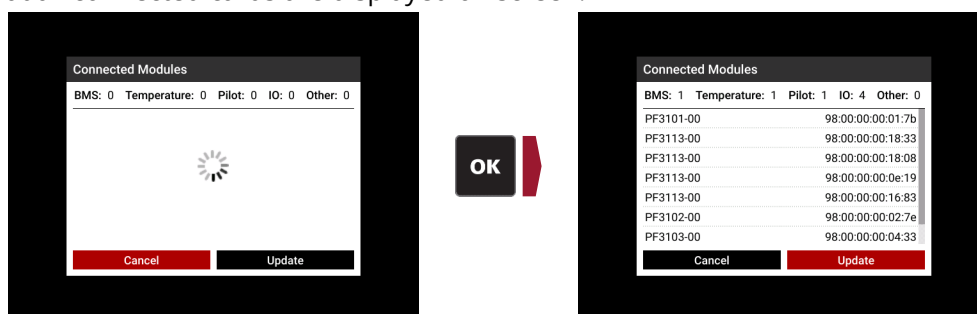

6. Select "Update" and press **OK**.

- Wait for the Update Report Screen to be shown and confirm that all cards have been updated.

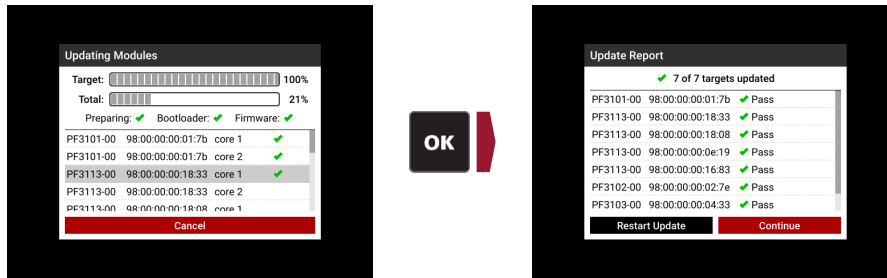

- If any cards were not updated successfully, select "Restart Update" and press **OK**. Otherwise, select "Continue" and press **OK**.
- Press **OK** to proceed to the update of the User Interface card.
- Select Restore to load the auto-saved settings from before the firmware update or navigate to the Settings Restore Utility to load saved settings from the USB storage device.

19 MAINTENANCE



Warning: Do not modify any system wiring or handle the electronics while the system is powered.



Caution: Do not disassemble or modify the cards in any way. The cards are not field repairable and must be sent back to Profire for replacement if damaged.



Caution: All enclosures must be securely closed after opening. Improper closure may result in moisture or other environmental damage and may compromise the integrity of the product.

19.1 TOOLS REQUIRED

The following tools are required for maintenance and commissioning:

- Large flat-head screwdriver to open and close enclosures.
- 3mm terminal block screwdriver for securing wiring to card terminal blocks.
- #1 and #2 Phillips screwdriver for removing and replacing cards in enclosures.
- Digital multimeter or process calibrator for troubleshooting.

19.2 REGULAR MAINTENANCE RECOMMENDATIONS

The following items should be performed periodically to ensure that the PF3100 control system is in good working order:

- Replace any cards or enclosures showing signs of damage, water ingress or corrosion.
- Validate functionality of UI screen and all keypad buttons.
- Ensure all electrical connections are properly terminated with minimal exposed copper in accordance with local electrical codes.
- Calibrate and validate functionality of all connected input and output devices (thermocouples, transmitters, valves, etc.)
- Validate system behavior under all shutdown conditions.
- Verify that all field inspection certifications are valid.

19.3 REPAIR AND REPLACEMENT

[Contact Profire](#) customer service for card replacements. Care must be taken when handling replacement cards to avoid damage and electrical static discharge. All replacement cards must be installed in place of the original card with four #10-32 screws tightened to 26 in*lb.

Ensure that a firmware update is performed on all replacement cards to ensure that all connected cards are running the same version of firmware.

19.4 DECOMMISSIONING

The useful life of the PF3100 is 10 years. When decommissioning the system, the appliance should be safely shut down (i.e., all safety outputs are turned off and there are no gas leaks on site). Once the appliance is in a safe state, the power should be disconnected from the PF3100. All electronics must be disposed of in accordance with local rules and regulations.

19.5 MANUFACTURER NOTIFICATION

Any failures that are detected and that compromise functional safety must be reported to Profire customer service as soon as possible.

20 ALERT CODES

20.1 ALARMS

Alarms are alerts that prevent a controller from entering any running state. The table below describes each alarm and indicates the unique shutdown codes used to identify them both over Modbus and on the UI.

Code		Alert Name	Description
UI/Modbus			
1000	1	Pilot Flame Detected While Off	Pilot flame is detected before the pilot ignition sequence is initiated.
1001	2	Main Flame Detected While Off	Main flame is detected before the pilot ignition sequence is initiated.
1002	3	POC Contact Open	The BMS Controller Proof of Closure input is de-energized when it is expected to be energized.
1003	4	POLF Contact Open	The BMS Controller Aux input (configured as a Proof of Low Fire input) is de-energized when in Pilot state or Incinerate No Assist state.
1004	5	POC2 Contact Open	The BMS Controller Aux input (configured as a Proof of Closure 2 input) is de-energized when it is expected to be energized.
1005	6	POP Contact Open	The BMS Controller Aux input (configured as a Proof of Pilot input) is de-energized when it is expected to be energized.
1006	7	Level/Flow Contact Open	4-20 Mode: This alarm cannot be set. Dry Contact Mode: The Appliance or Controller Level/Flow input is de-energized. * This alarm can only be present when the Level/Flow Restart setting is set to Disabled.
1007	8	Low Level/Flow	4-20 Mode: The BMS Appliance or Controller Level/Flow input reading is less than Low Level/Flow SP setting. Dry Contact Mode: This alarm cannot be set. * This alarm can only be present when the Low Level/Flow Restart setting is set to Disabled.
1008	9	Fuel Pressure Contact Open	4-20 Mode: This alarm cannot be set. Dry Contact Mode: The BMS Controller Pressure input is de-energized. Dry Contact High Press Mode: This alarm cannot be set.
1009	10	Low Fuel Pressure	4-20 Mode: BMS Controller Pressure input reading is less than its Low Pressure SP setting. Dry Contact Mode: This alarm cannot be set. Dry Contact High Press Mode: This alarm cannot be set * This alarm can only be present when the Low Fuel Pressure Restart setting is set to Disabled.
1010	11	Low Fuel Pressure Dry Contact	The Aux Input (configured as a Low Pressure input) is de-energized. * This alarm can only be present when the Low Fuel Pressure Restart setting is set to Disabled.
1011	12	ESD Contact Open	The ESD (Emergency Shutdown) input is de-energized.
1012	13	Primary Process Temperature High ESD	Process temperature input reading is above its High Temp SP setting.
1013	14	Incompatible Firmware	A card has a different firmware version than the BMS Controller to which it is connected.
1014	15	Reserved	
1015	16	Reserved	
1016	17	Pilot Solenoid Error * Alarm 1020 has the same name	A wiring or hardware error is detected on the Pilot- terminal (terminal 12) of the BMS Controller card.

Code		Alert Name	Description
UI/Modbus			
1017	18	SSV1 Solenoid Error * Alarm 1021 has the same name	A wiring or hardware error is detected on the SSV1- terminal (terminal 10) of the BMS Controller card.
1018	19	SSV2 Solenoid Error * Alarm 1022 has the same name	A wiring or hardware error is detected on the SSV2- terminal (terminal 8) of the BMS Controller card.
1019	20	HF Solenoid Error * Alarm 1023 has the same name	A wiring or hardware error is detected on the HFV- terminal (terminal 6) of the BMS Controller card.
1020	21	Pilot Solenoid Error * Alarm 1016 has the same name	A wiring or hardware error is detected on the Pilot+ terminal (terminal 13) of the BMS Controller card.
1021	22	SSV1 Solenoid Error * Alarm 1017 has the same name	A wiring or hardware error is detected on the SSV1+ terminal (terminal 11) of the BMS Controller card.
1022	23	SSV2 Solenoid Error * Alarm 1018 has the same name	A wiring or hardware error is detected on the SSV2+ terminal (terminal 9) of the BMS Controller card.
1023	24	HF Solenoid Error * Alarm 1019 has the same name	A wiring or hardware error is detected on the HFV+ terminal (terminal 7) of the BMS Controller card.
1024	25	Low Voltage	Any Mode: Temperature or Pilot card voltage is below 32V ¹ . 12V Mode: BMS Controller card input voltage is below 9.6V ¹ . 24V Mode: BMS Controller card input voltage is below 19.2V ¹ . ¹ This alarm can only be present when the Low Voltage Restart setting is set to Disabled. ² Pressing the OK button on the alert text opens a dialog that identifies the offending card and input.
1025	26	High Voltage	Any Mode: Temperature or Pilot card voltage is above 40V ¹ . 12V Mode: BMS Controller card input voltage is above 16.8V ¹ . 24V Mode: BMS Controller card input voltage is above 33.6V ¹ . ¹ This alarm can only be present when the High Voltage Restart setting is set to Disabled. ² Pressing the OK button on the alert text opens a dialog that identifies the offending card and input.
1026	27	Pilot Module Comm Error	PFRN connection between the BMS controller card and a Pilot card has been lost and the Minimum Pilots Running requirement is not satisfied. ¹ This alarm sets immediately when the Comm Loss Restart setting is Disabled and sets after 5 minutes when the Comm Loss Restart setting is Enabled. ² Pressing the OK button on the alert text opens a dialog that identifies the offending card.
1027	28	Incomplete Commissioning	The commissioning date setting has not been set.
1028	29	Cross Compare Failure	Internal BMS Controller card fault. Contact Profire.
1029	30	Cross Compare Packet Timeout	Internal BMS Controller card fault. Contact Profire.
1030	31	Factory Calibration Error	Internal BMS Controller card fault. Contact Profire. * This alarm can only be present when the Factory Cal Error Mode setting (BMS Settings > Calibration > BMS) is set to Alarm.

Code		Alert Name	Description
UI/Modbus			
1031	32	Invalid Configuration	<p>Each of the conditions in the following list cause this alarm. Pressing the OK button on the alert text opens a dialog with additional troubleshooting information:</p> <p>High Temp Setpoint Error:</p> <ol style="list-style-type: none"> 1. High Temp SP below Pilot Off SP (If Pilot off Mode = Pilot off at SP) 2. High Temp SP below Low Fire SP (If Low Fire setting is enabled) 3. High Temp SP below Process Temp SP <p>Pilot Off Setpoint Error:</p> <ol style="list-style-type: none"> 4. Pilot off SP below Low Fire SP (If Low Fire setting is enabled) 5. Pilot off SP below Process Temp SP <p>Low Fire Setpoint Error:</p> <ol style="list-style-type: none"> 6. Low Fire SP below Process Temp SP + 1 <p>Process SP Error:</p> <ol style="list-style-type: none"> 7. Process Temp SP below 0 <p>Main Flame Config Error</p> <ol style="list-style-type: none"> 8. Pilot Off Mode set to Off After Main On and Main Flame Detect is Disabled. <p>Level/Flow Setpoint Error:</p> <ol style="list-style-type: none"> 9. Level/Flow High SP below Low SP + Deadband (when in 4-20 mode) 10. Level/Flow Low SP below Deadband (when in 4-20 mode) <p>Pressure Setpoint Error:</p> <ol style="list-style-type: none"> 11. Pressure High SP below Low SP + Deadband (when in 4-20 mode) 12. Pressure Low SP below Deadband (when in 4-20 mode) <p>Appliance Configuration Error:</p> <ol style="list-style-type: none"> 13. Minimum Controllers Running setting is greater than the number of controllers in the appliance <p>Proof of Airflow Configuration Error:</p> <ol style="list-style-type: none"> 14. Proof of Airflow is enabled and HFV Mode setting is not set to Forced Draft or Purge Fan 15. HFV Mode setting is set to Forced Draft or Purge Fan and Proof of Airflow is not enabled <p>PID Configuration Error:</p> <ol style="list-style-type: none"> 16. 4-20 Aux Out Mode setting is set to PID Control or Appliance Firing Rate and Low Fire is disabled <p>Incinerator Configuration Error:</p> <ol style="list-style-type: none"> 17. Waste Gas Off SP is above Pilot Off SP 18. Assist Gas Off SP is above Waste Gas Off SP minus Waste Gas Off Deadband 19. Waste Gas On SP is above Assist Gas Off SP minus Assist Gas Off Deadband 20. Process Temp SP is above Assist Gas Off SP 21. Process Temp SP is below Waste Gas On SP.
1032	33	Ignition Switch Stuck	The BMS Controller Ignition Switch input is stuck in the Start position.
1033	34	Auxiliary Temperature High ESD	Auxiliary temperature input reading is above its High Temp SP setting.

Code		Alert Name	Description
UI/Modbus			
1034	35	Reserved	
1035	36	Pilot Load Monitor Error	AC voltage on Pilot ionization input too low to reliably detect flame. ¹ Usually caused by loading of the flame rod to ground ² Pressing the OK button on the alert text opens a dialog that identifies the offending card and input.
1036	37	Pilot Flame Detect Voltage Error	Pilot flame voltage test failure. Contact Profire. * Pressing the OK button on the alert text opens a dialog that identifies the offending card and input.
1037	38	Pilot Flame Quality Mismatch	Internal Pilot card fault. Contact Profire.
1038	39	Main Load Monitor Error	AC voltage on Main ionization input too low to reliably detect flame. ¹ Usually caused by loading of the flame rod to ground ² Pressing the OK button on the alert text opens a dialog that identifies the offending card and input.
1039	40	Main Flame Detect Voltage Error	Main flame voltage test failure. Contact Profire. * Pressing the OK button on the alert text opens a dialog that identifies the offending card and input.
1040	41	Main Flame Quality Mismatch	Internal Pilot card fault. Contact Profire.
1041	42	Ion Pilot Module Valve Test Failed	A wiring or hardware error is detected on the Valve+ terminal (terminal 4) of the Ion Pilot card.
1042	43	Ion Pilot Module Valve Test Failed	A wiring or hardware error is detected on the Valve- terminal (terminal 3) of the Ion Pilot card.
1043	44	Reserved	
1044	45	Reserved	
1045	46	Pilot Flame Fail	Pilot flame has been lost or failed to ignite
1046	47	Main Flame Fail	Main flame has been lost or failed to ignite
1047	48	High Fuel Pressure After Main On	4-20 Mode: BMS Controller Pressure input reading is greater than its High Pressure SP setting. * Dry Contact Mode: This alarm cannot be set. Dry Contact High Press Mode: BMS Controller Pressure input is de-energized. * * This alarm can only be present in main fuel states.
1048	49	Stopped Via External Switch	The BMS Controller Ignition Switch input is in the Stop position.
1049	50	User Stop	The Controller received a stop command from the UI card or through the Modbus card.
1050	51	Safety Core Temperature Too High	Card temperature is too high
1051	52	Safety Core Temperature Too Low	Card temperature is below rated minimum operating temperature
1052	53	Reserved	
1053	54	Controller Settings CRC Failed	The BMS Controller settings are invalid.
1054	55	Reserved	

Code		Alert Name	Description
UI/Modbus			
1055	56	Input Pin Connection Test Failed	Internal BMS Controller card fault. Contact Profire.
1056	57	State Mismatch	Internal BMS Controller card fault. Contact Profire.
1057	58	Reserved	
1058	59	Ion Aux In Tripped	<p>4-20 Mode: An Ion Pilot card LEL (Aux In) input reading is above the Ion Aux In Trip Point setting. ¹</p> <p>Dry Contact Mode: The Ion Pilot card LEL (Aux In) input is de-energized. ¹</p> <p>¹ This alarm can only be present when Ion Aux In Mode setting is set to High Trip Alarm</p> <p>² Pressing the OK button on the alert text opens a dialog that identifies the offending card and input.</p>
1059	60	Ion Aux In Contact Range Error	<p>4-20 Mode: An Ion Pilot card LEL (Aux In) input reading is below 3mA OR above 22 mA.</p> <p>Dry Contact Mode: Internal Ion Pilot card fault. Contact Profire.</p>
1060	61	Ion Aux In Contact Mismatch	Internal Ion Pilot card fault. Contact Profire.
1061	62	Ion Aux In Contact Cross Compare Failure	Internal Ion Pilot card fault. Contact Profire.
1062	63	Level/Flow Input Range Error	<p>4-20 Mode: The BMS Controller Level/Flow input reading is below 4-20 Low Range Limit setting OR above 4-20 High Range Limit setting (BMS Settings > Calibration > BMS 4-20 Inputs).</p> <p>Dry Contact Mode: Internal BMS card fault. Contact Profire.</p> <p>* This alarm can only be present for single controller appliances</p>
1063	64	Level/Flow Input Mismatch Error	<p>Internal BMS Controller card fault. Contact Profire.</p> <p>* This alarm can only be present for single controller appliances</p>
1064	65	Pressure Input Range Error	<p>4-20 Mode: The BMS Controller Pressure input reading is below 4-20 Low Range Limit setting OR above 4-20 High Range Limit setting (BMS Settings > Calibration > BMS 4-20 Inputs).</p> <p>Dry Contact Mode: Internal BMS card fault. Contact Profire.</p>
1065	66	Pressure Input Mismatch Error	Internal BMS Controller card fault. Contact Profire.
1066	67	Start Contact Mismatch Error	Internal BMS Controller card fault. Contact Profire.
1067	68	ESD Contact Mismatch Error	Internal BMS Controller card fault. Contact Profire.
1068	69	POC Contact Mismatch Error	Internal BMS Controller card fault. Contact Profire.
1069	70	Aux In Contact Mismatch Error	Internal BMS Controller card fault. Contact Profire.
1070	71	No Valid Primary Process Temperature	<p>The system does not have a valid Primary Process Temperature input reading due to configuration errors or communication loss.</p> <p>* Pressing the OK button on the alert text opens a dialog that identifies the offending card and input.</p>
1071	72	No Valid Auxiliary Temperature	<p>The system does not have a valid Auxiliary Temperature input reading due to configuration errors or communication loss.</p> <p>* Pressing the OK button on the alert text opens a dialog that identifies the offending card and input.</p>
1072	73	Reserved	

Code		Alert Name	Description
UI/Modbus			
1073	74	Reserved	
1074	75	No Appliance Level/Flow	The appliance does not have a Local Level/Flow Input enabled.
1075	76	Reserved	
1076	77	Appliance Startup Cancelled	The appliance startup was cancelled by the User Interface or Modbus card.
1077	78	Appliance Startup Timeout	The appliance was not able to successfully start all the BMS controllers within the appliance.
1078	79	Appliance Startup Mismatch	During appliance startup one of the BMS cards reported settings that did not match the other BMS cards.
1079	80	Reserved	
1080	81	Controller Disabled	This BMS has been disabled in the appliance settings.
1081	82	Minimum Controllers Rule Violated	Number of BMS Controllers running is less than the Min Controllers Running setting (BMS Settings > Setup > Commissioning).
1082	83	Controller Network Wiring Error	An I/O card is connected to the PFRN Controller Network (BMS Controller terminal 28).
1083	84	IO Network Wiring Error	A UI card or Modbus card is connected to the PFRN I/O Network (BMS Controller terminals 29,30,31 or 32).
1084	85	Failed to Prove Airflow While Running	The BMS Controller Aux input (configured as a Proof of Airflow input) is de-energized while in a fuel state, OR An I/O Expansion input (configured as a Proof of Airflow input) is not satisfied while in a fuel state.
1085	86	Failed to Prove Airflow While Purging	The BMS Controller Aux input (configured as a Proof of Airflow input) is de-energized while purging, OR An I/O Expansion input (configured as a Proof of Airflow input) is not satisfied while purging.
1086	87	Multiple Primary Process Temperatures	More than one temperature input is configured as a Primary Process input.
1087	88	Primary Process Temperature Configuration Error	Process Deadband setting is set above 100°C (180°F).
1088	89	Auxiliary Temperature Configuration Error	Aux Temp High Temp SP setting is set above 1350°C (2462°F), OR Aux Temp High Temp SP setting is less than Process Setpoint + 1, OR Auxiliary Temperature Deadband setting is set above 100°C (180°F)
1089	90	No Primary Process Temperature Configured	No temperature input has been configured as a Primary Process input.
1090	91	UV Flame Detect Fault	UV Pilot card Fault input de-energized.
1091	92	UV Flame Detect Mismatch	UV Pilot card Flame On and Flame Off inputs are either (1) both energized, or (2) both de-energized.
1092	93	UV Input Out of Range	UV Scanner input invalid. Contact Profire.
1093	94	UV Input Address Fault	Internal UV Pilot card fault. Contact Profire.

Code		Alert Name	Description
UI/Modbus			
1094	95	IO Expansion Input Invalid	An I/O Expansion card input configured as an alarm is not reading a valid input signal. * Pressing the OK button on the alert text opens a dialog that identifies the offending card and input.
1095	96	I/O Expansion POAF Input Invalid	The I/O Expansion card input configured as a Proof of Airflow input is not reading a valid input signal.
1096	97	IO Expansion Analog Input High	A 4-20mA I/O Expansion card input configured as an alarm is above its High Setpoint setting. * Pressing the OK button on the alert text opens a dialog that identifies the offending card and input.
1097	98	IO Expansion Analog Input Low	A 4-20mA I/O Expansion card input configured as an alarm is below its Low Setpoint setting. * Pressing the OK button on the alert text opens a dialog that identifies the offending card and input.
1098	99	IO Expansion Digital Input Open	A digital I/O Expansion card input configured as an alarm is de-energized. * Pressing the OK button on the alert text opens a dialog that identifies the offending card and input.
1099	100	IO Expansion Configuration Error	An IO Expansion card Alarm input satisfies any of the following: <ol style="list-style-type: none"> 1. 4-20mA input configured in Bleed Valve Proof of Open mode. 2. High setpoint is less than the low setpoint plus the deadband. 3. Digital input configured in any of the following modes: <ul style="list-style-type: none"> - Appliance Firing Rate - FARC Air/Fuel/Aux - O₂ Sensor - Secondary PID * Pressing the OK button on the alert text opens a dialog that identifies the offending card and input.
1100	101	Invalid Appliance Firing Rate Input	The I/O Expansion card input configured as a Firing Rate input is not reading a valid 4-20mA signal. * This alarm can only set when Manual Override setting is Disabled
1101	102	Failed to Prove Purge Position	An I/O Expansion card input configured as a FARC position feedback input is unsatisfied for the duration of the Request Purge Position state.
1102	103	Failed to Prove Pilot Position	An I/O Expansion card input configured as a FARC position feedback input is unsatisfied for the duration of the Request Pilot Position state.
1103	104	Failed to Prove Light Off Position	An I/O Expansion card input configured as a FARC position feedback input is unsatisfied for the duration of the Request Light Off Position Error timeout during the Pilot state.
1104	105	FARC Cross Limit Error	The cross limit error exceeds the configured Cross Limit Error setting.
1105	106	FARC Fuel Channel Position Error	The difference between the requested and actual position of the FARC fuel actuator exceeds the configured position error threshold.
1106	107	FARC Air Channel Position Error	The difference between the requested and actual position of the FARC air actuator exceeds the configured position error threshold.
1107	108	Reserved	

Code		Alert Name	Description
UI/Modbus			
1108	109	PID Configuration Error	4-20 Aux Out Mode setting is set to PID, Low Fire Mode setting is enabled and any of the following Advanced PID Config conditions exist: 1. Primary Setpoint Min > Primary Setpoint Max 2. Secondary Setpoint Min > Secondary Setpoint Max 3. Secondary Input invalid (Both a temperature input and I/O expansion input have been configured as Secondary PID inputs). 4. Staging Input Invalid (Input type selected in the I/O Expansion Wizard is not suitable for PID staging).
1109	110	Pilot Configuration Error	The number of connected and enabled Pilot cards is lower than the configured Minimum Pilots Running setting.
1110	111	Bleed Valve Closed with Main Off	The bleed valve proof of open contact is open, indicating the bleed valve is closed (no flow) during main off.
1111	112	Bleed Valve Open with Main ON	The bleed valve proof of open contact is closed, indicating that the bleed valve is open (flow) while the main is on.
1112	113	The Bleed Valve Input is Invalid	The bleed valve proof of open contact input is invalid.
1113	114	BMS Wait Timeout	A BMS wait has been present for longer than the configured BMS Wait Timeout setting.
1114	115	IO Expansion Wait Timeout	An IO Expansion wait has been present for longer than the configured IO Wait Timeout setting
1115	116	One or more descriptors are Invalid	Internal BMS Card Fault. Contact Profire.
1116	117	Settings CRC Mismatch	Settings have been corrupted and cannot be verified
1117	118	Airflow Input Stuck	The Proof of Airflow contact is closed during the Startup Checks State.
1118	119	Secondary PID Configuration Error	1. Input Mode setting (I/O Wizard > Add Inputs Tab) is configured as "Secondary PID input" for more than one input. 2. Secondary PID input Signal Type setting (I/O Wizard > Add Inputs Tab) is configured as "Digital" 3. Aux Out Mode setting (BMS Settings > Outputs > 4-20 Aux Out) is not set to "BMS PID". 4. Secondary PID input is not assigned as the Secondary Input (BMS Settings > Process Control > Advanced PID Config).
1119	120	UV Flame Detect Stale Data	Internal UV Pilot card fault. Contact Profire.
1120	121	IO 4-20 Output PID Configuration Error	4-20 Output setting (I/O Wizard > I/O Modules Tab) is set to PID Output Controlled by TC Input but has no temperature input assigned. * Pressing the OK button on the alert text opens a dialog that identifies the offending card and input.
1121	122	IO Expansion Dry Contact Configuration Error	IO Expansion Dry Contact setting (I/O Wizard > I/O Modules Tab) is configured as Temp Setpoint Trip or Input Setpoint Trip and Dry Contact Trip Configuration setting (I/O Wizard > I/O Modules Tab) is unassigned or assigned input has an invalid mode configured. * Pressing the OK button on the alert text opens a dialog that identifies the offending card and input.
1122	123	System is in Calibration Mode	The system is currently calibrating a 4-20 mA output.
1123	124	Low %O ₂	The Oxygen Sensor input reading is less than its configured Low Setpoint setting. * This alarm is ignored when the controller is not actively trimming O ₂ (e.g., the controller is not in Process Control or the warmup conditions have not been met).

Code		Alert Name	Description
UI/Modbus			
1124	125	Cross Limiting Enabled on Invalid Curve	Cross limiting is enabled on a curve that contains an inflection point.
1125	126	No Position Feedback On Cross Limited Channel	Cross limiting is enabled on a FARC channel that does not have a corresponding position feedback input configured.
1126	127	FARC Settings Error	Fuel or Air FARC channel settings have been improperly configured through a Settings Restore with a corrupted settings file.
1127	128	FARC Requires Proof of Airflow	FARC is enabled with no proof of airflow input configured.
1128	129	FARC Requires Forced Draft Fan	FARC is enabled and HFV Output Mode settings is not set to Forced Draft Fan.
1129	130	FARC Requires Low Fire	FARC is enabled and Low Fire Mode setting is set to Disabled.
1130	131	FARC Requires Aux Out	FARC is enabled and Aux Out Mode settings is not set to PID Control or Appliance Firing Rate.
1131	132	FARC Table Requires Commissioning	FARC is enabled and the currently selected FARC curve is not commissioned.
1132	133	FARC Fuel and Air Channels not Assigned	FARC is enabled with no corresponding Fuel or Air channels configured.
1133	134	FARC Air Control Output Configuration Error	FARC is enabled and there is: <ul style="list-style-type: none"> - More than one FARC Air Output configured, or - Less than one FARC Air Output configured.
1134	135	FARC Light Off Firing Rate Error	FARC is enabled and the Light Off Firing Rate setting is less than the Minimum Firing Rate setting.
1135	136	FARC Settings Out of Range	FARC Position error, cross limit error or FARC mode settings are configured with invalid values.
1136	137	FARC Aux 1 Channel Position Error	The difference between the requested and actual position of the FARC Aux 1 channel actuator exceeds the configured position error threshold.
1137	138	FARC Aux 2 Channel Position Error	The difference between the requested and actual position of the FARC Aux 2 channel actuator exceeds the configured position error threshold.
1138	139	FARC Aux 3 Channel Position Error	The difference between the requested and actual position of the FARC Aux 3 channel actuator exceeds the configured position error threshold.
1139	140	FARC Feedback Missing	FARC channel Position Feedback Setting is enabled with no corresponding feedback input configured.
1140	141	FARC Redundant Inputs	A FARC input is assigned to multiple IO Expansion input slots.
1141	142	Bleed Valve Proof of Open Configuration Error	There is more than one Bleed Valve Input configured or settings have been configured with invalid values.
1142	143	O ₂ Sensor Configuration Error	There is more than one O ₂ sensor input configured, or settings have been configured with invalid values.
1143	144	FARC Output Configuration Error	There are multiple outputs configured for a single FARC channel.
1144	145	Appliance Firing Rate Configuration Error	There is more than one Firing Rate input configured or settings have been configured with invalid values.
1145	146	Logical Temperature Input Name Collision	Two or more configured temperature inputs have the same name.
1146	147	Proof of Airflow Configuration Error	A single BMS has a Proof of Airflow input configured on both its Aux Input and its I/O Expansion card, or there is more than one Local Proof of Airflow logical input created in the I/O Wizard.
1147	148	TC Flame Detect Requires a 4-20 Input	TC Flame Detect is enabled and Ion Aux In / LEL Input is not configured as a 4-20mA input or TC Flame Detect is enabled with a UV Pilot card.
1148	149	O ₂ Trim Enabled Without Stack Input	O ₂ Sensor Warmup Mode setting is configured as Stack Temp with no valid temperature input assigned.

Code		Alert Name	Description
UI/Modbus			
1149	150	Manual O ₂ Trim Requires Manual FARC	O ₂ Trim Manual Mode setting is enabled, and FARC Manual Mode setting is disabled
1150	151	O ₂ Trim Requires Correctly Commissioned Curves	Commissioned O ₂ Trim target values do not have corresponding offset values set, or vice versa. The FARC table must also be commissioned.
1151	152	FARC Enabled on a Multi-Controller System	FARC is enabled on an appliance that has more than one controller.
1152	153	IO Expansion Span Config Error	An IO Expansion input has equal Span Max and Span Min settings.
1153	154	Controller Not In An Appliance	A controller is not recognized by the appliance. Re-run the Appliance Wizard.
1154	155	Low Heat Standby Configuration Error	Low Heat Standby setting is Enabled and BMS Aux Output setting is not set to one of the following: <ul style="list-style-type: none"> • Manual Control • PID Control • Appliance Firing rate
1155	156	FARC Feedback Configuration Error	An assigned FARC channel feedback input is not the correct type. Re-run the FARC/O ₂ Trim Wizard.
1156	157	O ₂ Trim Requires an O ₂ Sensor	O ₂ Trim setting is Enabled and no O ₂ Sensor has been configured in the I/O Expansion Wizard.

20.2 WAITS

Waits are alerts that prevent a controller from entering any fuel state. The table below describes each wait and indicates the unique codes used to identify them.

Code	Alert Name	Description
2000	Low Voltage	<p>Any Mode: Temperature or Pilot card voltage is below 32V ¹. 12V Mode: BMS Controller card input voltage is below 9.6V ¹. 24V Mode: BMS Controller card input voltage is below 19.2V ¹.</p> <p>¹ This wait can only be present when the Low Voltage Restart setting is set to Enabled. ² Pressing the OK button on the alert text opens a dialog that identifies the offending card and input.</p>
2001	High Voltage	<p>Any Mode: Temperature or Pilot card voltage is above 40V ¹. 12V Mode: BMS Controller card input voltage is above 16.8V ¹. 24V Mode: BMS Controller card input voltage is above 33.6V ¹.</p> <p>¹ This wait can only be present when the High Voltage Restart setting is set to Enabled. ² Pressing the OK button on the alert text opens a dialog that identifies the offending card and input.</p>
2002	Low Fuel Pressure	<p>4-20 Mode: BMS Controller Pressure input reading is less than its Low Pressure SP setting. Dry Contact Mode: This wait cannot be set. Dry Contact High Press Mode: This wait cannot be set</p> <p>* This wait can only be present when the Low Fuel Pressure Restart setting is set to Enabled and the Restart Mode setting is set to Wait.</p>
2003	Low Fuel Pressure Dry Contact	<p>The Aux Input (Configured as a Low Pressure input) is de-energized.</p> <p>* This wait can only be present when the Low Fuel Pressure Restart setting is set to Enabled and the Restart Mode setting is set to Wait.</p>
2004	Low Level/Flow	<p>4-20 Mode: The Appliance or Controller Level/Flow input reading is less than Low Level/Flow SP setting. Dry Contact Mode: This alarm cannot be set.</p> <p>* This wait can only be present when the Low Level/Flow Restart setting is set to Enabled.</p>
2005	Proc Temp Too High	<p>The process temperature input reading is too high for the controller to transition into a fuel state.</p>
2006	Start Contact Open	<p>The BMS Controller Start input is de-energized.</p>
2007	Purging	<p>The BMS Controller has de-energized all its safety outputs and is waiting for the duration of the Purge Time setting (BMS Settings > Process Control > Timing).</p>
2008	Loss of Communications	<p>PFRN connection between the BMS controller card and a Pilot card has been lost.</p> <p>* This wait can only be present when the Comm Loss Restart setting (BMS Settings > Setup > Other) is set to Enabled.</p>

Code	Alert Name	Description
2009	IO Expansion Input Invalid	An I/O Expansion card input configured as a wait is not reading a valid input signal. * Pressing the OK button on the alert text opens a dialog that identifies the offending card and input.
2010	IO Expansion Analog Input High	A 4-20mA I/O Expansion card input configured as a wait is above its High Setpoint setting. * Pressing the OK button on the alert text opens a dialog that identifies the offending card and input.
2011	IO Expansion Analog Input Low	A 4-20mA I/O Expansion card input configured as a wait is below its Low Setpoint setting. * Pressing the OK button on the alert text opens a dialog that identifies the offending card and input.
2012	IO Expansion Digital Input Open	A digital I/O Expansion card input configured as a wait is de-energized. * Pressing the OK button on the alert text opens a dialog that identifies the offending card and input.
2013	Level/Flow Contact Open	4-20 Mode: This alarm cannot be set. Dry Contact Mode: The Appliance or Controller Level/Flow input is de-energized. * This wait can only be present when the Level/Flow Restart setting is set to Enabled.
2014	IO Expansion Configuration Error	An IO Expansion card Wait input satisfies any of the following: <ol style="list-style-type: none"> 1. 4-20mA input configured in Bleed Valve Proof of Open mode. 2. High setpoint is less than the low setpoint plus the deadband. 3. Digital input configured in any of the following modes: <ul style="list-style-type: none"> - Appliance Firing Rate - FARC Air/Fuel/Aux - O₂ Sensor - Secondary PID * Pressing the OK button on the alert text opens a dialog that identifies the offending card and input.
2015	Low Heat Standby	Low Heat Standby Mode is configured as a Wait, the Controller is in the PID Control State, and one of the following conditions is present for the duration of the configured Low Heat Standby Delay: <ol style="list-style-type: none"> 1. Basic PID: Firing Rate is at the configured Minimum Firing Rate and the Process Temperature is greater than the Process Setpoint. 2. Cascaded PID: PID Process Setpoint is at the configured Primary Setpoint Min setting and the Process Temperature is greater than the Primary Setpoint Min setting and Secondary Input is greater than the Secondary Process Setpoint minus Deadband.

20.3 WARNINGS

Warnings are alerts that are displayed only and do not affect controller operation in any way. The table below describes each warning and indicates the unique codes used to identify them.

Code	Alert Name	Description
3000	Low Voltage	12V Mode: BMS Controller card input voltage is between 9.6V and 9.9V. 24V Mode: BMS Controller card input voltage is between 19.2V and 19.9V. * Pressing the OK button on the alert text opens a dialog that identifies the offending card and input.
3001	High Voltage	12V Mode: BMS Controller card input voltage is between 16.1V and 16.8V. 24V Mode: BMS Controller card input voltage is between 33.1V and 33.6V. * Pressing the OK button on the alert text opens a dialog that identifies the offending card and input.
3002	High Fuel Pressure	4-20 Mode: BMS Controller Pressure input reading is greater than its High Pressure SP setting. * Dry Contact Mode: This warning cannot be set. Dry Contact High Press Mode: BMS Controller Pressure input is de-energized. * * This warning can only be present in non-fuel states.
3003	Low Process Temp	The process temperature input reading is less than its Low Temp SP setting.
3004	High Level/Flow	4-20 Mode: The Appliance or Controller Level/Flow input reading is above the High Level/Flow SP setting. Dry Contact Mode: This warning cannot be set.
3005	Reserved	
3006	Grounded Thermocouple	A Temperature card thermocouple input is detecting a grounded thermocouple. * Pressing the OK button on the alert text opens a dialog that identifies the offending card and input.
3007	POC Contact Failed to Open	The BMS Controller Proof of Closure input is energized when it is expected to be de-energized.
3008	POC2 Contact Failed to Open	The BMS Controller Aux input (configured as a Proof of Closure 2 input) is energized when it is expected to be de-energized.
3009	POP Contact Failed to Open	The BMS Controller Aux input (configured as a Proof of Pilot input) is energized when it is expected to be de-energized.
3010	Thermocouple Failure	A configured temperature card input is open or invalid, OR Readings from a dual element thermocouple do not match, OR Internal temperature card ambient temperature fault. Contact Profire . * Pressing the OK button on the alert text opens a dialog that identifies the offending card and input.
3011	High Auxiliary Temperature	A Temperature card input configured as a High Temp ESD input is reading a value above its High Temp Warning SP setting.

Code	Alert Name	Description
3012	Factory Calibration Error	Internal BMS Controller card fault. Contact Profire . * This warning can only be present when the Factory Cal Error Mode setting (BMS Settings > Calibration > BMS) is set to Warning.
3013	Level/Flow Input Range Error	4-20 Mode: The BMS Controller Level/Flow input reading is below 4-20 Low Range Limit setting OR above 4-20 High Range Limit setting (BMS Settings > Calibration > BMS 4-20 Inputs). Dry Contact Mode: Internal BMS card fault. Contact Profire . * This warning can only be present for multiple controller appliances
3014	Level/Flow Input Mismatch Error	Internal BMS Controller card fault. Contact Profire . * This warning can only be present for multiple controller appliances
3015	Appliance Communication Error	A BMS controller assigned to the appliance is not communicating.
3016	Partially Running Appliance	An appliance has a combination of both stopped and running BMS controllers.
3017	IO Expansion Input Invalid	An I/O Expansion card input configured as a warning is not reading a valid input signal. * Pressing the OK button on the alert text opens a dialog that identifies the offending card and input.
3018	IO Expansion Analog Input High	A 4-20mA I/O Expansion card input configured as a warning is above its High Setpoint setting. * Pressing the OK button on the alert text opens a dialog that identifies the offending card and input.
3019	IO Expansion Analog Input Low	A 4-20mA I/O Expansion card input configured as a warning is below its Low Setpoint setting. * Pressing the OK button on the alert text opens a dialog that identifies the offending card and input.
3020	IO Expansion Digital Input Open	A digital I/O Expansion card input configured as a warning is de-energized. * Pressing the OK button on the alert text opens a dialog that identifies the offending card and input.
3021	IO Expansion Configuration Error	An IO Expansion card Warning input satisfies any of the following: <ol style="list-style-type: none"> 1. 4-20mA input configured in Bleed Valve Proof of Open mode. 2. High setpoint is less than the low setpoint plus the deadband. 3. Digital input configured in any of the following modes: <ul style="list-style-type: none"> - Appliance Firing Rate - FARC Air/Fuel/Aux - O₂ Sensor - Secondary PID * Pressing the OK button on the alert text opens a dialog that identifies the offending card and input.

Code	Alert Name	Description
3022	PID Configuration Warning	<p>4-20 Aux Out Mode setting is set to PID, Low Fire Mode setting is enabled and any of the following Advanced PID Config conditions exist:</p> <ol style="list-style-type: none"> 1. Cascade Primary SP Max is above Low Fire SP 2. Cascade Primary SP Max is below Process Temp SP 3. Cascade Primary SP Min is above Process Temp SP 4. Cascade Primary SP Min is below 0 5. Cascade Secondary SP Max is below Secondary SP 6. Cascade Secondary SP Min is above Secondary SP 7. Cascade Secondary SP Min is below 0 8. Cascade Primary/Secondary out of range <p>* Pressing the OK button on the alert text opens a dialog that identifies the offending card and input.</p>
3023	Pilot Module Comm Warning	Controller has lost communication with a pilot card.
3024	FARC System In Manual Mode	FARC Manual Mode setting is enabled.
3025	Appliance Firing Rate Input Invalid	The I/O Expansion card input configured as a Firing Rate input is not reading a valid 4-20mA signal and Aux Out Manual Override setting is enabled.
3026	IO Expansion Module Internal Voltage Fault	<p>Internal card fault. Contact Profire.</p> <p>* Pressing the OK button on the alert text opens a dialog that identifies the offending card and input.</p>
3027	O ₂ Trim at Limit	<p>The Oxygen Sensor input reading is at its configured Max or Min Setpoint setting.</p> <p>* This warning is hidden when the controller is not actively trimming O₂ (e.g., the controller is not in Process Control or the warmup conditions have not been met).</p>
3028	High Measured %O ₂	<p>The Oxygen Sensor input reading is above its configured High Setpoint setting.</p> <p>* This warning is hidden when the controller is not actively trimming O₂ (e.g., the controller is not in Process Control or the warmup conditions have not been met).</p>
3029	Manual O ₂ Trim	O ₂ Trim Manual Mode setting is enabled

20.4 MAIN PERMISSIVES

Main Permissives are alerts that prevent a controller from entering any main fuel state. The table below describes each main permissive and indicates the unique codes used to identify them.

Code	Alert Name	Description
4000	Low Fuel Pressure	<p>4-20 Mode: BMS Controller Pressure input reading is less than its Low Pressure SP setting.</p> <p>Dry Contact Mode: This alarm cannot be set.</p> <p>Dry Contact High Press Mode: This alarm cannot be set</p> <p>* This alarm can only be present when the Low Fuel Pressure Restart setting is set to Enabled and the Restart Mode setting is set to Main Permissive.</p>
4001	Aux In Low Fuel Pressure	<p>BMS Controller Aux input (configured as a Low Pressure input) is de-energized.</p> <p>* This alarm can only be present when the Low Fuel Pressure Restart setting is set to Enabled and the Restart Mode setting is set to Main Permissive.</p>
4002	Switching to Curve A	The BMS Controller is holding the main valves de-energized while switching from FARC Curve B to FARC curve A.
4003	Switching to Curve B	The BMS Controller is holding the main valves de-energized while switching from FARC Curve A to FARC curve B.
4004	IO Expansion Input Invalid	<p>An I/O Expansion card input configured as a main permissive is not reading a valid input signal.</p> <p>* Pressing the OK button on the alert text opens a dialog that identifies the offending card and input.</p>
4005	IO Expansion Analog Input High	<p>A 4-20mA I/O Expansion card input configured as a main permissive is above its High Setpoint setting.</p> <p>* Pressing the OK button on the alert text opens a dialog that identifies the offending card and input.</p>

Code	Alert Name	Description
4006	IO Expansion Analog Input Low	<p>A 4-20mA I/O Expansion card input configured as a main permissive is below its Low Setpoint setting.</p> <p>* Pressing the OK button on the alert text opens a dialog that identifies the offending card and input.</p>
4007	IO Expansion Analog Input Open	<p>A digital I/O Expansion card input configured as a main permissive is de-energized.</p> <p>* Pressing the OK button on the alert text opens a dialog that identifies the offending card and input.</p>
4008	IO Expansion Configuration Error	<p>An IO Expansion card Main Permissive input satisfies any of the following:</p> <ol style="list-style-type: none"> 1. 4-20mA input configured in Bleed Valve Proof of Open mode. 2. High setpoint is less than the low setpoint plus the deadband. 3. Digital input configured in any of the following modes: <ul style="list-style-type: none"> - Appliance Firing Rate - FARC Air/Fuel/Aux - O₂ Sensor - Secondary PID <p>* Pressing the OK button on the alert text opens a dialog that identifies the offending card and input.</p>
4009	Aux In Contact Open	<p>The Aux Input (configured as a Main Permissive input) is de-energized.</p>
4010	Low Heat Standby	<p>Low Heat Standby Mode is configured as a Main Permissive, the Controller is in the PID Control State, and one of the following conditions is present for the duration of the configured Low Heat Standby Delay:</p> <ol style="list-style-type: none"> 1. Basic PID: Firing Rate is at the configured Minimum Firing Rate and the Process Temperature is greater than the Process Setpoint. 2. Cascaded PID: PID Process Setpoint is at the configured Primary Setpoint Min setting and the Process Temperature is greater than the Primary Setpoint Min setting.

21 GLOSSARY

21.1 TERMS

Term	Definition
Flame Establishment Period	The time between the signal to initiate fuel flow and the signal indicating presence of flame.
Flame Failure Lock-Out Time / Flame Failure Response Time (FFRT)	The time between the signal indicating absence of flame and de-energization of the safety outputs (Lockout).
Ignition Time	The time for which the ignition outputs are energized during a trial for ignition.
Post Purge Time	Purge time that takes place immediately following the shutting off of the fuel supply.
Pre-Purge Time	The time between the confirmation of proof of airflow and the admission of fuel to the burner.
Purge Time	Period during which air is introduced to displace air/fuel mixtures or products of combustion from the combustion zone and flue ways.
Recycle Time	The time between the signal to de-energize safety outputs following a loss of flame and the signal to initiate a system restart.
Start-up Lock-out Time	The time between fuel flow energizing on start-up to fuel flow de-energizing due to no flame presence.

21.2 ACRONYMS

Term	Definition
BMS	Burner Management System
ESD	Emergency Shutdown
HEI	High Energy Ignition
HFV	High Fire Valve
LED	Light Emitting Diode
PFRN	Profire Reliability Network. Proprietary communication protocol
PID	Proportional-integral-derivative
POC	Proof of Closure
PWM	Pulse Width Modulation
SIL	Safety Integrity Level
SSV	Safety Shutoff Valve
UI	User Interface

22 DOCUMENT REVISION HISTORY

22.1 HARDWARE AND FIRMWARE VERSIONS

Document Version	Release Date	Applicable System Firmware	Applicable Card Hardware								
			PF3100-00 UI Card	PF3101-00 BMS Controller Card	PF3102-00 Ion Pilot Card	PF3102-01 UV Pilot Card	PF3102-03 Pilot Spark Card	PF3103-00 Temperature Card	PF3106-00 Network Switch Card	PF3107-00 Modbus Comm Card	PF3113-00 I/O Expansion Card
v8.0	14 NOV 2022	NA-43.3	v1.3.x	v1.3.x	v2.2.x	v1.0.x	v1.1.x	v1.4.x	v2.1.x	v1.3.x	v2.0.x
v7.0	26 OCT 2022	NA-43.2	v1.3.x	v1.3.x	v2.2.x	v1.0.x	v1.1.x	v1.4.x	v2.1.x	v1.3.x	v2.0.x
v6.0	21 OCT 2022	NA-43.1	v1.3.x	v1.3.x	v2.2.x	v1.0.x	v1.1.x	v1.4.x	v2.1.x	v1.3.x	v2.0.x
v5.0	31 JAN 2022	NA-43	v1.3.x	v1.3.x	v2.2.x	v1.0.x	v1.1.x	v1.4.x	v2.1.x	v1.3.x	v2.0.x
v4.0	30 JUN 2020	NA-41	v1.3.x	v1.3.x	v2.2.x	v1.0.x	v1.1.x	v1.4.x	v2.1.x	v1.3.x	v2.0.x
v3.0	20 NOV 2018	NA-40	v1.3.x	v1.3.x	v2.2.x	v1.0.x	v1.1.x	v1.4.x	v2.1.x	v1.3.x	v2.0.x

22.2 DOCUMENT CHANGE SUMMARY

22.2.1 VERSION 8.0

- Updated Flame Detection threshold notes to specify behavior changes under flame sharing conditions
- Updated applicable firmware versions to include NA-43.3 release

22.2.2 VERSION 7.0

- No material changes
- Updated applicable firmware versions to include NA-43.2 release

22.2.3 VERSION 6.0

- Updated per changes in NA-43.1 software release
- Updated Pilot communication loss behavior
- Changed name of FARC Direction setting to Output Inversion
- Updated O2 Trim setting minimum and maximum allowable values



UNITED STATES

1.801.796.5127
321 South, 1250 West Suite 1
Lindon, UT 84042, USA
support@profireenergy.com

CANADA

1.780.960.5278
9671 – 283 Street
Acheson, AB T7X 6J5, Canada
support@profireenergy.com