



PF2200 - SB

PRODUCT MANUAL

**Warning:**

All PF2200 installations must follow the installation, commissioning, operation, and maintenance procedures outlined in this manual. Failure to comply with the instructions and warnings in this manual may result in death, serious injury, electrocution, property damage, product damage, and/or government fines. All PF2200 installations must be performed in accordance with local electrical code(s) by a capable electrician, and must be field inspected by the Authority Having Jurisdiction to ensure compliance with local electrical and gas codes.

Explosion Hazard. Do not connect or disconnect when energized.

Do not service or open enclosure unless power has been switched off or the area is known to be non-hazardous.

Do not remove or replace fuse when system is powered. Replacement fuses must be ceramic and of correct rating (10A, 150V_{DC}, Slow Blow). Contact Profire for fuse replacements.

All safety functions must be end-to-end proven following commissioning of the system.

Substitution of components may impair suitability for Class I, Division 2.

**Avertissement:**

Toutes les installations PF2200 doivent être conformes aux procédures d'installation, de mise en service, d'utilisation et d'entretien décrites dans ce manuel. Le non-respect des instructions et des avertissements de ce manuel peut entraîner la mort, des blessures graves, l'électrocution, des dommages matériels, des dommages au produit et/ou des amendes gouvernementales. Toutes les installations PF2200 doivent être effectuées conformément au(x) code(s) électrique(s) local(aux) par un électricien compétent, et doivent être inspectées sur place par l'autorité compétente afin de garantir la conformité aux codes locaux de l'électricité et du gaz.

Risque d'explosion. Ne pas brancher ni débrancher sous tension.

Ne pas réparer ou ouvrir le boîtier si l'instrument est sous tension ou que la zone est reconnue pour être non-dangereuse.

Ne pas retirer ou remplacer le fusible lorsque le système est sous tension. Les fusibles de remplacement doivent être en céramique et de valeur nominale correcte (10A, 150VDC, slow blow). Contactez Profire pour le remplacement des fusibles.

Toutes les fonctions de sécurité doivent être éprouvées de bout en bout après la mise en service du système.

La substitution de composants peut rendre ce matériel inacceptable pour les emplacements de Classe I, Division 2.

CONTENTS

1 SCOPE.....	4	6 INSTALLATION.....	62
2 APPROVALS AND RATINGS	4	6.1 Mounting Considerations.....	62
2.1 Product Declarations	5	6.2 Connection Diagrams	63
2.2 Electrical And Mechanical Ratings	6	7 SYSTEM CONFIGURATION	70
3 USER INTERFACE CARD	9	7.1 Temperatures	70
3.1 Keypad	9	7.2 Inputs.....	73
3.2 Controller Interface	10	7.3 Process Control.....	76
3.3 Status LED.....	15	7.4 Outputs.....	78
3.4 Modbus Communication	16	7.5 Setup	79
3.5 USB Port.....	16	8 MAINTENANCE	81
4 BMS CARD	17	8.1 Recommended Maintenance Procedures.....	81
4.1 Pressure Input	18	8.2 Transportation and Storage Conditions	81
4.2 High Pressure Input	19	8.3 Repair and Replacement	82
4.3 Proof of Light Off Input.....	20	8.4 Decommissioning.....	82
4.4 Proof of Closure Input.....	21	8.5 Useful Life.....	82
4.5 Temperature Control Valve Output.....	22	8.6 Manufacturer Notification.....	82
4.6 Pilot 1 Valve Solenoid Output	23	9 TROUBLESHOOTING	83
4.7 Pilot 2 Valve Solenoid Output	24	10 ALERT CODES & RESPONSE TIMES	84
4.8 Main Valve Solenoid Outputs.....	25	10.1 Alarms.....	84
4.9 High Fire Valve Solenoid Output.....	26	10.2 Waits	88
4.10 Status Contact.....	27	10.3 Warnings.....	89
4.11 Controller Power Input	28	10.4 Main Permissives.....	90
4.12 Emergency Shutdown Input.....	29	11 GLOSSARY	91
4.13 Remote Start Input	30	12 ACRONYMS	92
4.14 Auxiliary Outputs	31	13 DOCUMENT REVISION HISTORY	93
4.15 Level/Flow Input	32	13.1 Change Summary	93
4.16 Auxiliary Temperature Input.....	33		
4.17 Auxiliary Inputs	34		
4.18 UV Flame Detection Inputs.....	36		
4.19 Pilot Ignition I/O	37		
4.20 External Ignition Switch Input	38		
4.21 Bath Temperature Input.....	39		
4.22 Outlet Temperature Input	40		
4.23 Stack Temperature Input.....	41		
5 OPERATING SEQUENCE	42		
5.1 Power On State	43		
5.2 Lockout State	44		
5.3 Alarm State	46		
5.4 Ready State.....	47		
5.5 Waiting State	48		
5.6 Ignition State	50		
5.7 Pilot State.....	51		
5.8 Main Light Off State.....	53		
5.9 Process Control States.....	55		

1 SCOPE

The PF2200-SB Burner Management System is an automated safety controller designed to monitor and control industrial heating processes that utilize single burner natural draft appliances. It provides for safe burner ignition, ionization or UV flame detection, temperature control and peripheral input device monitoring. The user interface provides real-time system status and state information as well as detailed alert annunciation, advanced diagnostics and data logging. The system has been optimized for power consumption to be utilized in a variety of applications and can be monitored remotely.

This document provides detailed descriptions of the PF2200-SB inputs, outputs and operating sequence as well as installation, maintenance and commissioning instructions. This document is applicable for the following hardware and firmware versions:

BMS Card Hardware Version	UI Card Hardware Version	PF2200-SB Firmware Version
v2.3.x	v3.2.x	SB 2.2.0

Contact Profire if you require a previous version of the PF2200-SB Product Manual.

The card hardware versions and current system firmware can be found on the Information screen (System > Firmware > Info) of the User Interface, where the BOM Version corresponds to the card hardware and Bundle Version corresponds to the system firmware. Additionally, the card hardware version is printed on the last line of the QR code label affixed to each card.

Note that the BMS firmware version and the UI firmware version must match in order for the system to operate correctly. Mismatched firmware is not supported.

2 APPROVALS AND RATINGS

The PF2200-SB is approved for use in a 1oo1 deployment configuration and is certified to the following standards:



SIL 2 Capable
IEC 61508: 2010 Parts 1-7



Electrical Burner Control System
UL 60730-2-5/ ANSI Z21.20-2014 • CSA C22.2 No. 60730-2-5
Class I Div 2 Group A, B, C & D, T4A (Class I, Zone 2, Group IIC – US Only)
UL 121201 • CSA-C22.2 No. 213



Type 4X
CSA C22.2 No. 94.1:15 • CSA C22.2 No. 94.2:15, Ed. 2
UL 50:15, Ed. 13 • UL 50E:15, Ed. 2
IP66
CSA-C22.2 No. 60529:16

2.1 PRODUCT DECLARATIONS

System Parameter	Value
Maximum Flame Detector Response Time	50ms
Minimum Flame Detector Self-Checking Rate	1Hz
Maximum Ionization Flame Failure Lock-Out Time	4s
Maximum UV Flame Failure Lock-Out Time	1s
Maximum Flame-Failure Reignition Time	120s ^{Note 1}
Maximum Ignition Time	10.6s
Maximum Pilot-Flame Establishing Period	10s
Maximum Main-Flame Establishing Period	10s
Maximum Post-Ignition Time	2.5s
Maximum Pre-Ignition Time	600ms
Minimum Post-Purge Time	10s
Minimum Recycle Time	10s ^{Note 2}
Maximum Start-up Lock-Out Time	10s ^{Note 3}
Maximum Number of Start-Up Retries	3
Minimum Waiting Time	5s ^{Note 4}
Pollution Degree	1 ^{Note 5}
Signal for Absence/Presence of Flame	-2.54V ^{Note 6}
High Voltage Spark Gap Range	2 – 8mm
Types of Action	Type 2: Electronic Disconnection, Non-volatile Lockout, Permanent Operation
Types of Burners	Full Rate Start and Low Rate Start
Type of Control	Incorporated Control
Types of Ignition	Interrupted
Types of Pilot	Continuous, Intermittent and Interrupted

¹ Flame-failure Reignition Time is only utilized when Reignition mode is enabled, both Pilots have enabled flame detection and when the other flame is continuously proven.

² Automatic Recycle is only permitted upon loss of a proven flame when configured **Relight Attempts** settings is not set to **0**.

³ Since recycling is allowed, this time is from fuel flow energizing on start-up to fuel flow de-energize due to no flame presence.

⁴ Assuming a purge has already elapsed. If system is purging the start command is delayed until the purge is complete.

⁵ Pollution degree when installed in enclosure with a rating of IP54 or equivalent

⁶ Flame signal is the amount that the AC signal being applied to the flame rod is rectified (i.e. the DC offset to the AC waveform)

2.2 ELECTRICAL AND MECHANICAL RATINGS

2.2.1 PRODUCT RATINGS

Item	Rating
Temperature - Operating/Storage	-40°C to 55°C (-40°F to 131°F)
Voltage Range	12V Mode: 10.2 - 16.2 V _{DC} • 24V Mode: 20.4 - 32.4 V _{DC}
Humidity - Product	0% to 100% Condensing
Humidity - BMS and UI Card	0% to 90% Non-condensing
Vibration - Tested	3g swept from 10Hz to 150Hz, 10 consecutive sweeps, 3-axis
Enclosure ¹	304 Stainless Steel, Type 4X, IP66
Enclosure Dimensions	335mm x 251mm x 145mm (13.2" x 9.9" x 5.7")
Enclosure Weight	7.26 kg / 16 lbs.
Power Consumption ²	12V Mode 24 Mode
Running • Backlight off • No USB	0.7W 0.9W
Running • Backlight off • USB installed	1.1W 1.3W
Running • Backlight on • USB installed	1.3W ³ 1.5W ³

¹ A #2 Phillips screwdriver is required to open and close the enclosure.

² Power consumption numbers are for the PF2200 controller only. Ensure that all external loads (e.g., valves, ignition coils, 4-20mA Transmitters, etc.) are factored in when selecting a power supply for the system.

³ The screen backlight remains on while UI buttons are being pressed and turns off after 10 minutes of inactivity.

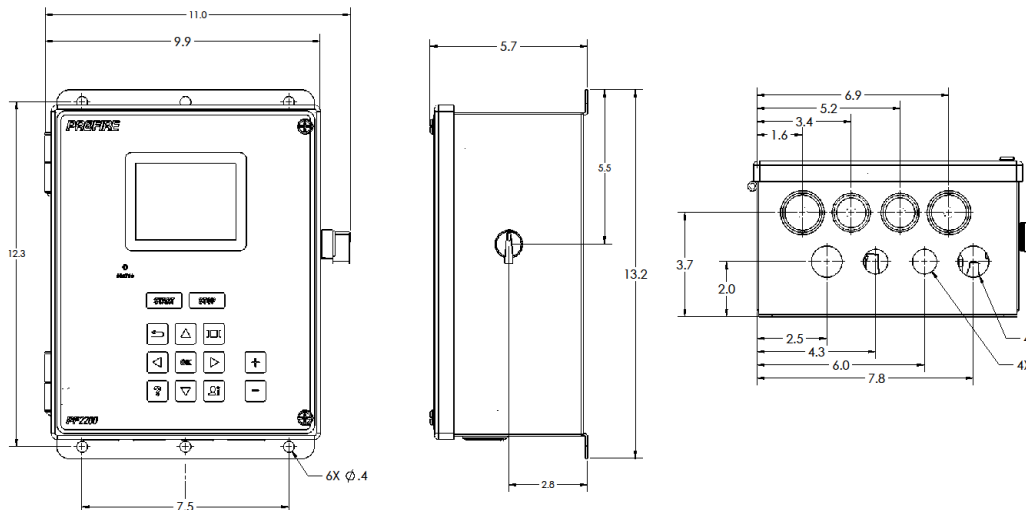

2.2.2 USER INTERFACE CARD ELECTRICAL RATINGS

	Terminal	Input/ Output	Rating	AWG		Torque (Nm)		
				Min	Max	Min	Max	
MODBUS	1	A	RS-485, -7V – 7V Common Mode Range with reference to terminal 3 (-)	30	14	0.22	0.25	
	2	B						
	3	-						
PFN	4	+	Power In: 7-35V _{DC} , 500mA Max PFN: -7V – 7V Common Mode Range	30	14	0.22	0.25	
	5	PFN A						I/O
	6	PFN B						I/O
	7	-						
USB	-	USB	I/O	5V _{DC} , 200mA max	-	-	-	-
KEYPAD	-	KEYPAD	I	3V _{DC} , 4.75kΩ source impedance	-	-	-	-

2.2.3 BMS CARD ELECTRICAL RATINGS

Name	Safety Rated	Terminal	Input/ Output	Rating	AWG ⁵		Torque (Nm)	
					Min	Max	Min	Max
USER INTERFACE	NO	1 +	O					
		2 PFN A	I/O	Power Out: 7-35V _{DC} , 500mA Max	30	14	0.22	0.25
		3 PFN B	I/O	PFN: -7V – 7V Common Mode Range				
		4 -	O					
PRESS.	YES	5 PWR	O	12V Mode: 12V _{DC} , 24V Mode: 13.5V _{DC} , 30mA Max				
PRESS. HIGH	YES	6 SIG IN	I	30V _{DC} Max ^{3 4}	30	12	0.5	0.6
		7 PWR	O	12V Mode: 12V _{DC} , 24V Mode: 13.5V _{DC} , 30mA Max				
PoL	YES	8 SIG IN	I	30V _{DC} Max ³	30	12	0.5	0.6
		9 PWR	O	12V Mode: 12V _{DC} , 24V Mode: 13.5V _{DC} , 30mA Max				
PoC	YES	10 SIG IN	I	30V _{DC} Max ^{3 4}	30	12	0.5	0.6
		11 PWR	O	12V Mode: 12V _{DC} , 24V Mode: 13.5V _{DC} , 30mA Max				
TCV	NO	12 SIG IN	I	30V _{DC} Max ³	30	12	0.5	0.6
		13 OUT	O	20mA Max Output, Expected Load: < 350Ω				
PILOT 1	YES	14 GND		±0.1 mA Accuracy	30	12	0.5	0.6
		15 +	O					
PILOT 2	YES	16 -	O		30	12	0.5	0.6
		17 +	O					
SSV	YES	18 -	O	12V _{DC} /24V _{DC}	30	12	0.5	0.6
		19 +	O	5A Max				
		20 -	O	Pulsed Output with configurable PWM				
		21 +	O	Expected Load: Inductive/Resistive				
HIGH FIRE	NO	22 -	O		30	12	0.5	0.6
		23 +	O					
RUN STATUS	NO	24 -	O		30	12	0.5	0.6
		25 A	-	120V, 170Vpk Max				
		26 NOT USED		1500V Max impulse				
POWER IN	NO	27 B	-	1A _{RMS} Max	30	12	0.5	0.6
		28 -						
		29 -		Class 2 Power Supply ¹				
		30 -	I	12V _{DC} /24V _{DC}				
		31 +	I	10A Max				
ESD	YES	32 +			30	12	0.5	0.6
		33 PWR	O	12V Mode: 12V _{DC} , 24V Mode: 13.5V _{DC} , 30mA Max				
START	YES	34 SIG IN	I	30V _{DC} Max ³	30	12	0.5	0.6
		35 PWR	O	12V Mode: 12V _{DC} , 24V Mode: 13.5V _{DC} , 30mA Max				
AUX OUT 1	NO	36 SIG IN	I	30V _{DC} Max ³	30	12	0.5	0.6
		37 OUT	O	20mA Max Output				
AUX OUT 2	NO	38 GND		Expected Load: < 350Ω	30	12	0.5	0.6
		39 OUT	O	±0.1 mA Accuracy				
LEVEL	YES	40 GND			30	12	0.5	0.6
		41 PWR	O	12V Mode: 12V _{DC} , 24V Mode: 13.5V _{DC} , 30mA Max				
		42 SIG IN	I	30V _{DC} Max ^{3 4}				

Name	Safety Rated	Terminal	Input/ Output	Rating	AWG ⁵		Torque (Nm)	
					Min	Max	Min	Max
AUX TEMP	YES	43 PWR	O	12V Mode: 12V _{DC} , 24V Mode: 13.5V _{DC} , 30mA Max	30	12	0.5	0.6
		44 SIG IN	I	30V _{DC} Max ⁴				
AUX IN 1	YES	45 PWR	O	12V Mode: 12V _{DC} , 24V Mode: 13.5V _{DC} , 30mA Max	30	12	0.5	0.6
		46 SIG IN	I	30V _{DC} Max ^{3 4}				
AUX IN 2	YES	47 PWR	O	12V Mode: 12V _{DC} , 24V Mode: 13.5V _{DC} , 30mA Max	30	12	0.5	0.6
		48 SIG IN	I	30V _{DC} Max ^{3 4}				
UV SCANNER	YES	49 PWR	O	12V Mode: 12V _{DC} , 24V Mode: 13.5V _{DC} , 30mA Max	30	12	0.5	0.6
		50 FAULT	I	30V _{DC} Max ³				
		51 FLAME	I	30V _{DC} Max ³				
PILOT 1 ION	YES	53 +	I/O	Intermittent 80-130 V _{RMS} Output	30	12	0.5	0.6
		54 -	I/O					
PILOT 1 COIL	YES	55 -	O	12V _{DC} /24V _{DC} Pulsed Output	30	12	0.5	0.6
		56 +	O	Expected Load: Inductive				
PILOT 2 ION	YES	57 +	I/O	Intermittent 80-130 V _{RMS} Output	30	12	0.5	0.6
		58 -	I/O					
PILOT 2 COIL	YES	59 -	O	12V _{DC} /24V _{DC} Pulsed Output	30	12	0.5	0.6
		60 +	O	Expected Load: Inductive				
BATH	YES ²	61 +	I	Thermocouple Mode: Type K Grounded or Ungrounded -100 °C to 1350 °C ±2 °C Accuracy	30	12	0.22	0.25
		62 -	I					
		63 R	I					
		64 +	I					
		65 -	I					
OUTLET	NO	66 R	I	RTD Mode: PT-100 RTD -100 °C to 850 °C ±0.5 °C Accuracy	30	12	0.22	0.25
		67 +	I					
		68 -	I					
STACK	NO	69 R	I		30	12	0.22	0.25
		70 +	I					
SWITCH ⁶	YES	71 -	I	3.3V _{DC} max	30	12	0.22	0.25
		- RUN	I					
		- IGN	I					
		- PWR	O	3.3V _{DC} , 1kΩ source impedance				

¹ The PF2200 must be powered from a Class 2 circuit as defined in the Canadian Electrical Code (CSA 22.2 No 1-15) or US National Electrical Code (NFPA 70).

² The Bath Temperature Input is safety rated ONLY if the input is configured as a Dual. If configured as a Single element the Bath temperature input is NOT safety rated.

³ A digital input with an input current of 1.25mA or greater will be seen by the system as an energized input, while a digital input with an input current of 500µA or less will be seen by the system as a de-energized input.

⁴ Input accuracy when configured in 4-20mA mode: ±0.1 mA









⁵ All wire sizes listed indicate the size restrictions of the BMS connector only. All wires must be adequately sized for their respective current requirements in accordance with local electrical codes.

⁶ Ignition Switch contacts must (1) be connected to a pre-wired, Profire-supplied PF2200 ignition switch (Part No. PFA-004260) or (2) have RUN and PWR terminals connected with a wire jumper.

3 USER INTERFACE CARD

The User Interface Card allows interaction with the system through the use of the keypad, display, Modbus port, and USB port. The card interacts with the BMS card through a proprietary communication protocol called PFN, which utilizes the RS-485 physical transport layer. PFN and power to the User Interface are factory wired to the BMS card through a wiring harness.

3.1 KEYPAD

Button	Functions
	Start the system from Ready state Reignite when one pilot is lost while running
	Stop the system ¹
	Return to previous screen from an on-screen menu
	Cycle through Status, Settings, and System screens
	Display keypad functionality help screen
	Switch to Commissioner Mode to see all available settings Switch to Operator Mode to see only essential settings and setpoints
	Navigate Menus and highlight items
	Select highlighted item Open settings adjustment dialog when highlighting numeric settings
	Change Status screen display mode Make incremental changes to numeric settings Scroll Event Log by full page

¹ The keypad is intended to aid in commissioning and system navigation, and it must not be incorporated into any safety function. If user shut-down is a required safety function, then the BMS Card ESD input or External Ignition Switch must be used.

Use the Keypad Diagnostic Tool (System > Diagnostics > Keypad) to check the functionality of each button individually.

3.2 CONTROLLER INTERFACE

The PF2200-SB controller consists of 3 main screens:

1. Status Screen – Always-on display that shows real-time system data including input device readings, controller state and alerts
2. Settings Screen – Screen containing all the configuration settings required to set up the system
3. System Screen – Screen containing tools for data logging and settings backup as well as a suite of diagnostic information for troubleshooting

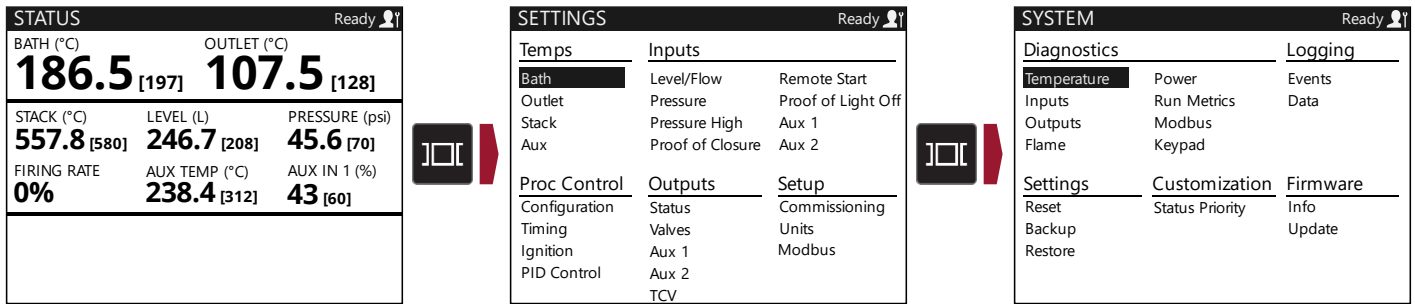

3.2.1 STATUS SCREEN

The Status Screen displays the current controller state in the Status Bar at the top of the Status Screen. All current alarms, waits, warnings, and main permissives are displayed in the Alerts Pane at the bottom of the Status Screen. The main window of the Status Screen shows the current states/readings of the connected input devices.

The information displayed can be customized to show one, five, or eight status elements; use **+** and **-** to cycle between the one-item, five-item, and eight-item zoom levels. The order in which the status elements are displayed on each zoom level can be customized using the Status Priority Tool (System > Customization > Status Priority).

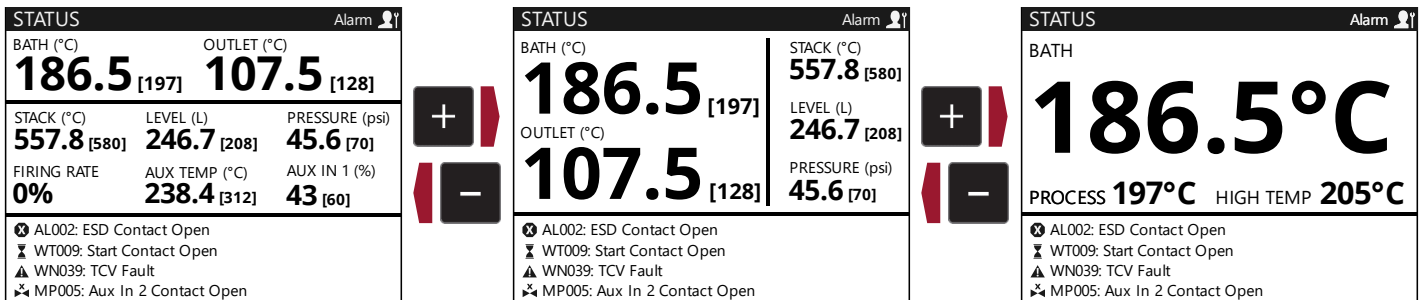

3.2.2 SETTINGS SCREEN

The Settings Screen contains sub-menus for all configuration settings required to commission a system. Use to select a menu and press to see a list of all related settings. By default, the Settings Screen is shown in Operator Mode, so a limited number of settings are displayed for quickly making changes after the system has been commissioned. Pressing will switch to Commissioning Mode and read-only access will be granted to all settings.

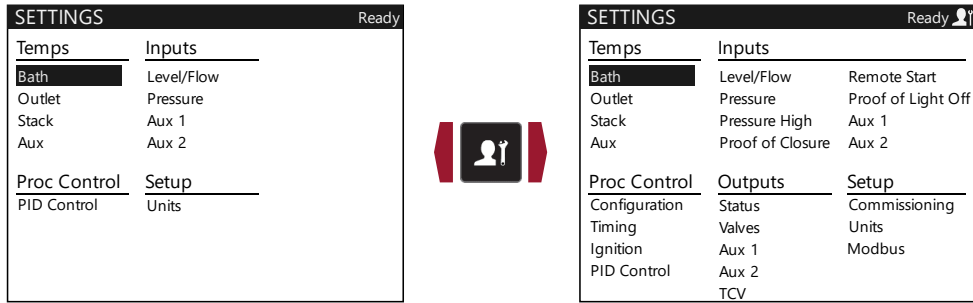

A valid password must be entered when prompted in order to adjust any setting. Each setting has a pre-determined security level based on its potential safety and reliability impact, and each security level has a separate password.

- L1 security level: settings that DO NOT impact the safety-integrity of the system BUT can impact the process operation.

If the **L1 Password Enable** setting is **Enabled**, L1 setting modification requires the L1 password. If the **L1 Password Enable** setting is **Disabled**, L1 settings can be modified with no password.

- L2 security level: settings that DO impact the safety-integrity of the system

For L1 and L2 passwords, please contact Profire customer service. Passwords will only be distributed to individuals that are capable of assessing the safety impact of the changes they intend to make.

After entering a valid password, the user is authenticated and can make changes to the associated settings. The authentication will timeout after 15 minutes regardless of activity. Any further attempt to adjust settings requires the user to re-authenticate.

DROP DOWN SETTINGS MODIFICATION

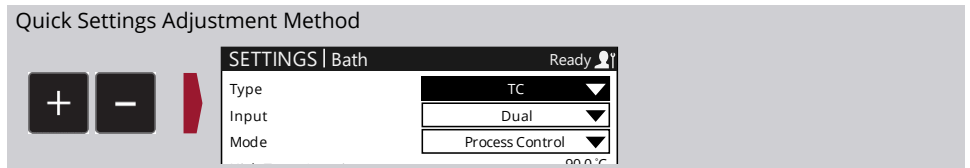
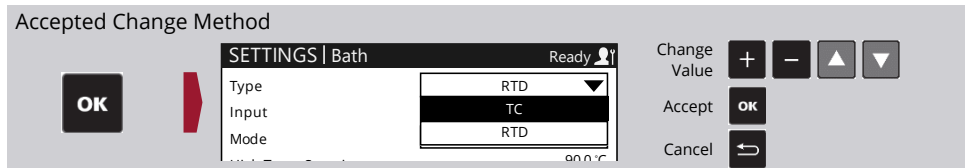
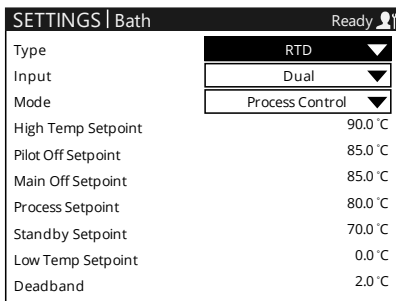

NUMERIC SETTINGS MODIFICATION

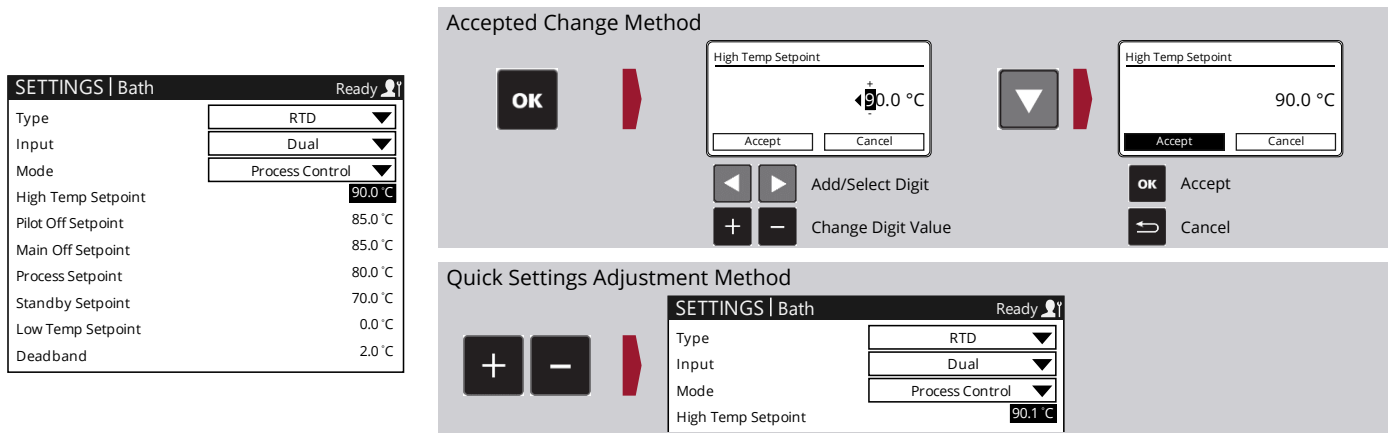

Settings changes made using the Quick Settings Adjustment methods take effect immediately when changed. Settings changes made using the Accepted Change method do not take effect until after the change has been accepted by the user. When using the accepted change method, pressing  will discard a change that has not yet been accepted by the user.

3.2.3 SYSTEM SCREEN

The PF2200 Systems screen contains tools for system monitoring, troubleshooting, and customization. The diagnostics menus contain useful real-time troubleshooting information, the logging tools provide detailed event history and data logging functionality, the settings tools allow saving and loading of settings between controllers, and the status priority tool allows for customization of the information displayed on the Status screen.

DIAGNOSTICS

Menu Item	Description
Temperature Diagnostics	Displays real-time temperature readings of all temperature inputs and ambient temperature sensors.
Input Diagnostics	Displays real-time external switch position and voltage or current readings of all BMS inputs.
Output Diagnostics	Displays real-time TCV output position and power consumption readings for all solenoid outputs.
Flame Diagnostics	Displays real-time flame strength information, flame fails since last power cycle and allowable relights remaining.
Power Diagnostics	Displays real-time and average hourly power consumption readings.
Run Metrics	Displays system and valve run times since last power cycle and cumulative pilot and main light off failures since last power cycle.
Modbus Diagnostics	Displays Modbus transmission statistics, error counts and key troubleshooting information.
Keypad Diagnostics	Interactive tool for testing the functionality of each key on the keypad.

LOGGING

EVENT LOG

The Event Log screen displays a full history of system events for reference and troubleshooting. Events are continuously recorded to the USB storage device when inserted.

The event log displays all events that are stored on the USB storage device. If no USB is installed, the system only displays a limited number of past events and gets cleared upon power cycle. When the USB device is full, the oldest event will be deleted to make room for a new event to be logged.

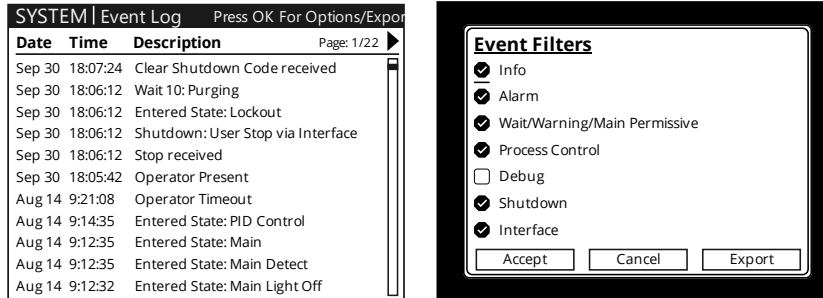

Use the event log filter to view specific events on the system screen. All event types will still be logged to the USB storage device, regardless of the filters selected.

DATA LOGGING

The Data Logging tool logs input/output readings for up to 8 user selectable pieces of system information to the USB storage device. The data is logged in 15 second intervals and saved to the USB storage device regularly.

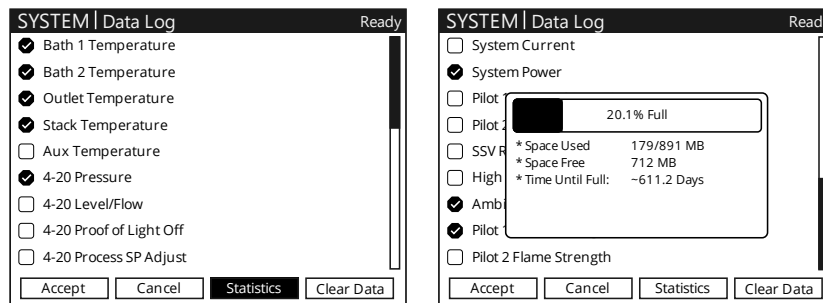

Use the Data Log Statistics window to see an estimate of how long the system will run before the USB storage device becomes full. Once full, the oldest data will be deleted and replaced with new data.

SETTINGS

Menu Item	Description
Reset	Resets all BMS settings to their default values.
Backup	Saves all current BMS settings to the USB storage device.
Restore	Tool to load BMS settings from the USB storage device.

Some settings may not be restored when loading a settings file from a system with a different version of firmware installed. The settings restore tool provides a list of all settings that were not restored. Ensure that all settings are correct after using the Settings Restore tool.

STATUS PRIORITY

The Status Priority tool allows configuration of the items displayed on the main Status screen. Use ▲ and ▼ to select a status element and + and - to move it up or down the priority list.

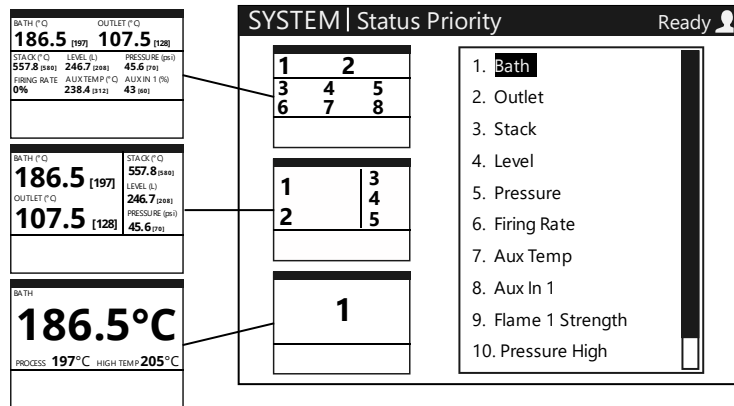

The images on the Status Priority screen represent the Status screen and show how the status elements will be displayed in the one, five, or eight element Status screen views.

FIRMWARE

INFORMATION

The Information screen shows displays useful firmware and hardware information associated with the BMS and UI cards.

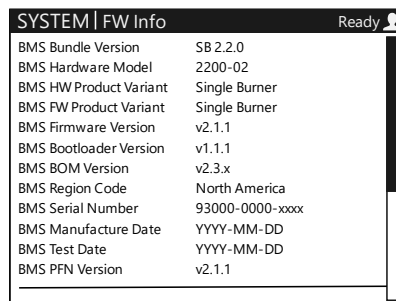

It is useful to have this system information on hand when contacting Profire for technical support.

UPDATE

The Firmware Update tool facilitates system software upgrades in the field. A USB drive containing an approved firmware bundle file can be used to update the system.

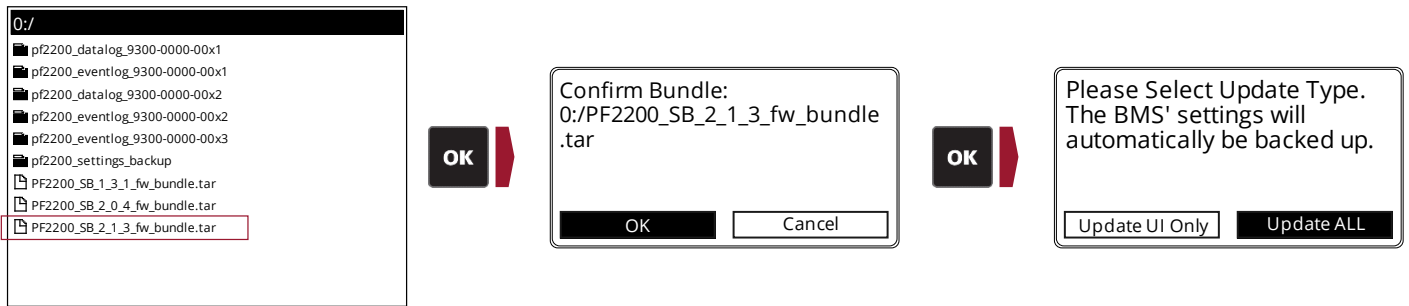

3.3 STATUS LED

The LED on the front of the PF2200-SB indicates the current operating state of the system.

3.3.1 STATUS LED BEHAVIOR

System state	Condition	Behavior
Power On	Any	Cycles Green, Amber, Red
Alarm	Any	Slow flashing Red
Ready	Any	Solid Red
Lockout	Any	Fast flashing Red
Waiting	No Warning present	Slow flashing Green
	Warning present	Slow flashing Amber
Ignition	No Warning present	Solid Green
	Warning present	Solid Amber
Pilot	No Warning present	Solid Green
	Warning present	Solid Amber
Main Light Off	No Warning present	Solid Green
	Warning present	Solid Amber
Process Control	No Warning present	Solid Green
	Warning present	Solid Amber

3.4 MODBUS COMMUNICATION

Remote access to status information and non-safety critical settings is available via the Modbus terminals on the UI card. Refer to the PF2200-SB Modbus Configuration Guide for detailed programming information.

3.4.1 INTENDED FIELD DEVICE CONNECTIONS

Field Device	Configuration Requirements	Connection Diagrams
Modbus Communication Module -Terminating resistor not required	Settings > Setup > Modbus Modbus RTU Communication: Enabled Modbus Termination: Disabled All other settings: As desired	Modbus Input Wiring
Modbus Communication Module -Terminating resistor required	Settings > Setup > Modbus Modbus RTU Communication: Enabled Modbus Termination: Enabled All other settings: As desired	Modbus Input Wiring
Not Used	Settings > Setup > Modbus Modbus RTU Communication: Disabled	N/A

Navigate to the Modbus Diagnostics Screen (System > Diagnostics > Modbus) for useful Modbus troubleshooting information.

3.5 USB PORT

The USB port of the User Interface card is used for data-logging as well as settings backup and restore functionality.

3.5.1 USB FUNCTIONS

Function	Configuration Requirements
Event logging to USB	System > Logging > Events No configuration required - Event log is automatically stored to USB when installed
Data logging to USB	System > Logging > Data Select up to 8 items to log
Saving current controller settings to USB	System > Settings > Backup
Loading saved controller settings from USB	System > Settings > Restore Select desired file to load

An approved USB storage device must be used; use of a non-approved USB storage device may compromise USB functionality. Each PF2200 is shipped with one approved USB storage device. Please contact Profire for replacements.

4 BMS CARD

The BMS card provides the necessary inputs and outputs to safely control a burner as well as additional inputs and outputs to reliably accommodate a variety of single burner applications. The following section outlines the behavior and intended device connections for each BMS input and output and provides brief configuration instructions and links to the appropriate [Connection Diagrams](#).

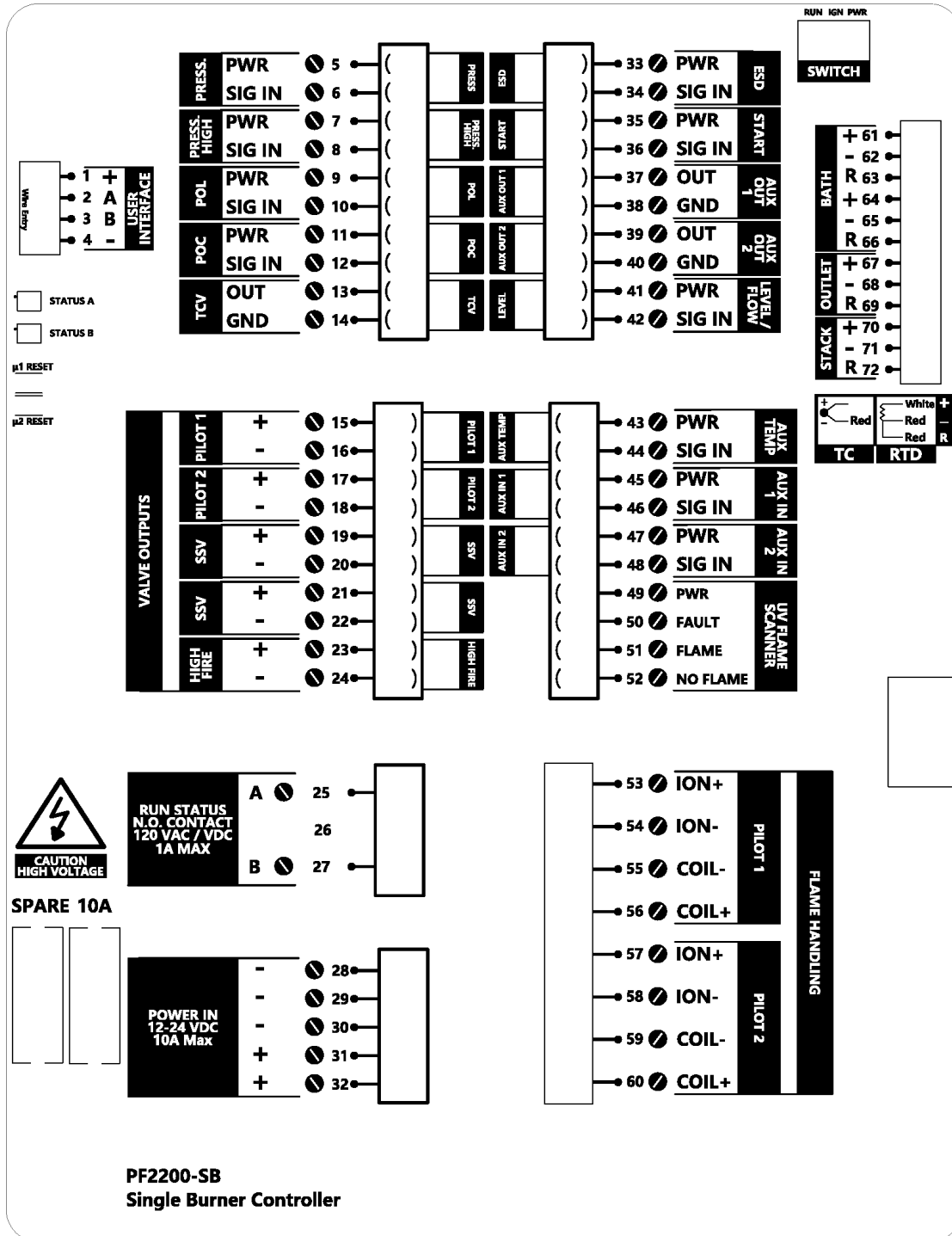

4.1 PRESSURE INPUT

4.1.1 DETAILS

Item	
Terminals	5 & 6
Name	PRESS
Type	Configurable digital or 4-20mA input

4.1.2 INTENDED FIELD DEVICE CONNECTIONS

Field Device	Configuration Requirements	Connection Diagrams
Low-pressure switch	Settings > Inputs > Pressure Type: Digital Low Pressure Mode: As desired All other settings: Ignored System > Customization > Status Priority As desired	Digital Input – Dry Contact Digital Input – Wet Contact
4-20mA pressure transmitter	Settings > Inputs > Pressure Type: 4-20 Span Min/Max: transmitter Min/Max All other settings: As desired Settings > Setup > Units Pressure: As desired System > Customization > Status Priority As desired	Analog Input - Loop Powered 4-20mA Transmitter Analog Input – Self Powered 4-20mA Transmitter
Not Used	Settings > Inputs > Pressure Type: Disabled	N/A

The Pressure input must be connected to a low-pressure switch when configured as a digital input. The High Pressure Input (terminals 7 & 8) must be used to connect a high pressure switch.

4.1.3 SYSTEM BEHAVIOR

Configuration Details	Scenario				
	Pressure Input State	SSV Output State	State Transition if Running	Alerts Pane	
Type: Digital	Low Pressure Mode: Alarm	De-energized	Any	Lockout	Low Pressure Alarm
	Low Pressure Mode: Wait	De-energized	Any	Waiting	Low Pressure Wait
	Low Pressure Mode: Warning	De-energized	Any	No effect	Low Pressure Warning
	Low Pressure Mode: Main Permissive	De-energized	Any	Pilot ¹	Low Pressure Main Permissive
	Any	Energized	Any	No effect	N/A
	Any	Out of Range	Any	Lockout	Pressure Range Alarm
Type: 4-20	Any	High Trip	De-energized	No effect	High Pressure Warning
	Any	High Trip	Energized	Lockout	High Pressure Alarm
	Low Pressure Mode: Alarm	Low Trip	Any	Lockout	Low Pressure Alarm
	Low Pressure Mode: Wait	Low Trip	Any	Waiting	Low Pressure Wait
	Low Pressure Mode: Warning	Low Trip	Any	No effect	Low Pressure Warning
	Low Pressure Mode: Main Permissive	Low Trip	Any	Pilot ¹	Low Pressure Main Permissive

¹ No effect if running in the Waiting state

A high-pressure event on the Pressure input will cause the burner to transition to the Lockout state only if it persists once the burner has entered a main fuel state. In any other state, the system will display a high pressure warning in the Alerts Pane and the burner will continue to run. This is true only when the **Pressure Type** setting is set to **4-20**. The state of the SSV Output is not considered when **Type** is set to **Digital**.

4.2 HIGH PRESSURE INPUT

4.2.1 DETAILS

Item	
Terminals	7 & 8
Name	PRESS HIGH
Type	Digital input

4.2.2 INTENDED FIELD DEVICE CONNECTIONS

Field Device	Configuration Requirements	Connection Diagrams
High pressure switch	Settings > Inputs > Pressure High Pressure High: Enabled System > Customization > Status Priority As desired	Digital Input – Dry Contact Digital Input – Wet Contact
Not Used	Settings > Inputs > Pressure High Pressure High: Disabled	N/A

4.2.3 SYSTEM BEHAVIOR

Configuration Details	Pressure High Input state	State Transition if Running	Alerts Pane
Pressure High: Enabled	De-energized	Lockout	High Pressure Alarm
	Energized	No effect	N/A
Pressure High: Disabled	Any	No effect	N/A

4.3 PROOF OF LIGHT OFF INPUT

4.3.1 DETAILS

Item

Terminals	9 & 10
Name	POL
Type	Configurable Digital or 4-20mA Input

4.3.2 INTENDED FIELD DEVICE CONNECTIONS

Field Device	Configuration Requirements	Connection Diagrams
Temperature control valve with 4-20mA position output signal	Settings > Inputs > Proof of Light Off Type: 4-20 All other settings: As desired	Analog Input – Self Powered 4-20mA Transmitter
Temperature control valve with digital proof of position switch	Settings > Inputs > Proof of Light Off Type: Digital All other settings: Ignored	Digital Input – Dry Contact Digital Input – Wet Contact
Digital proof of closure switch on the High Fire valve	Settings > Inputs > Proof of Light Off Type: Digital All other settings: Ignored Settings > Proc Control > Configuration Process Control Mode: Staged Heating	Digital Input – Dry Contact Digital Input – Wet Contact
Not Used	Settings > Inputs > Proof of Light Off Type: Disabled	N/A

The Proof of Light Off position is only checked upon transition from the Pilot state to the Main Light Off State. If satisfied within the user configurable Request Light Off Delay Time, the system proceeds to light off the main burner. Otherwise, the system will transition to the Lockout state.

4.3.3 SYSTEM BEHAVIOR

Configuration Details	Scenario		System State Transition	Alerts Pane/Lockout Message
	Initial System State	PoL Input State		
Type: Digital	Main Light Off	De-energized	Lockout	Failed to Prove Light Off Position
	All but Main Light Off	De-energized	No effect	N/A
	Main Light Off	Energized	Proceeds with Main Light Off	N/A
	All but Main Light Off	Energized	No effect	N/A
Type: 4-20	Any	Out of Range	Lockout	Proof of Light Off Out of Range
	Main Light Off	High or Low Trip	Lockout	Failed to Prove Light Off Position
	All but Main Light Off	High or Low Trip	No effect	N/A
	Main Light Off	Within tolerance of setpoint	Proceeds with Main Light Off	N/A
	All but Main Light Off	Within tolerance of setpoint	No effect	N/A
Type: Disabled	Any	Any	No effect	N/A

4.4 PROOF OF CLOSURE INPUT

4.4.1 DETAILS

Item	
Terminals	11 & 12
Name	POC
Type	Digital input

4.4.2 INTENDED FIELD DEVICE CONNECTIONS

Field Device	Configuration Requirements	Connection Diagrams
Main Valve (SSV) Proof of Closure Switch	Settings > Inputs > Proof of Closure Proof of Closure: Enabled	Digital Input – Dry Contact Digital Input – Wet Contact
Not Used	Settings > Inputs > Proof of Closure Proof of Closure: Disabled	N/A

4.4.3 SYSTEM BEHAVIOR

Configuration Details	Scenario		State Transition if Running	Alerts Pane
	SSV Output state	POC Input state		
Proof Closure: Enabled	De-energized	De-energized	Lockout	Proof of Closure Contact Open Alarm
	Energized	Energized	No effect	Proof of Closure Contact Failed to Open Warning
	De-energized	Energized	No effect	N/A
	Energized	De-energized	No effect	N/A
Proof Closure: Disabled	Any	Any	No effect	N/A

4.5 TEMPERATURE CONTROL VALVE OUTPUT

4.5.1 DETAILS

Item	
Terminals	13 & 14
Name	TCV
Type	4-20mA output

4.5.2 INTENDED FIELD DEVICE CONNECTIONS

Field Device	Configuration Requirements	Connection Diagrams
4-20mA Proportional Fuel Gas Valve using internal PID algorithm	Settings > Outputs > TCV All settings: As desired Settings > Inputs > Proof of Light Off All settings: As desired Settings > Proc Control > Configuration Process Control Mode: PID Control Settings > Proc Control > PID Control All settings: As desired	TCV Output Wiring
	Settings > Outputs > TCV Min Position: As desired All other settings: Ignored Settings > Inputs > Proof of Light Off All settings: As desired Settings > Proc Control > Configuration Process Control Mode: External Firing Rate Settings > Inputs > Aux 1 ¹ Type: 4-20 4-20 Mode: Appliance Firing Rate	TCV Output Wiring
Not Used	N/A	N/A

¹ External Firing rate can also be configured on the Aux In 2 input

4.5.3 SYSTEM BEHAVIOR

System State	PoL Input Type	TCV Position by State in each Process Control Mode		
		On/Off Control OR Staged Heating	PID Control	External Firing Rate
Power On	Any	Purge position	Purge position	Purge position
Lockout	Any	Purge position	Purge position	Purge position
Alarm	Any	Purge position	Purge position	Purge position
Ready	Any	Purge position	Purge position	Purge position
Waiting	Any	Purge position	Purge position	Purge position
Ignition	Any	Pilot position	Pilot position	Pilot position
Pilot	Any	Pilot Position	Pilot Position	Pilot Position
Main Light Off – Before Mains Energize	Disabled	Minimum Position	Minimum Position	Minimum Position
	Enabled	Proof of Light Off Setpoint	Proof of Light Off Setpoint	Proof of Light Off Setpoint
Main Light Off – After Mains Energize	Any	Minimum Position	Minimum Position	Echoes Aux In Firing rate input above Minimum Position
Process Control	Any	100%	Variable between Minimum Position and 100%	Echoes Aux In Firing rate input above Minimum Position

4.6 PILOT 1 VALVE SOLENOID OUTPUT

4.6.1 DETAILS

Item	
Terminals	15 & 16
Name	PILOT 1
Type	Powered solenoid valve output with configurable PWM

4.6.2 INTENDED FIELD DEVICE CONNECTIONS

Field Device	Configuration Requirements	Connection Diagrams
Normally Closed Pilot Gas Shutoff Valve - Peak and Hold	Settings > Proc Control > Configuration Pilot Off Mode: As desired Pilot 2: As desired Minimum Pilots Running: As desired Reignition: As desired Settings > Proc Control > Timing Pilot Startup Delay Time: As desired Settings > Outputs > Valves Pilot Valve PWM: As desired	Solenoid Output – 12V/24V
	Settings > Proc Control > Configuration Pilot Off Mode: As desired Pilot 2: As desired Minimum Pilots Running: As desired Reignition: As desired Settings > Proc Control > Timing Pilot Startup Delay Time: As desired Settings > Outputs > Valves Pilot Valve PWM: 100%	Solenoid Output – 12V/24V
Normally Closed Pilot Gas Shutoff Valve – Constant current	Settings > Proc Control > Configuration Pilot Off Mode: As desired Pilot 2: As desired Minimum Pilots Running: As desired Reignition: As desired Settings > Proc Control > Timing Pilot Startup Delay Time: As desired Settings > Outputs > Valves Pilot Valve PWM: 100%	Solenoid Output – 12V/24V

4.6.3 SYSTEM BEHAVIOR



System State	Pilot 1 Output
Power On	De-energized
Lockout	De-energized
Alarm	De-energized
Ready	De-energized
Waiting	De-energized
Ignition	Energized
Pilot	Energized ¹
Main Light Off	Energized ^{1 2}
Process Control	Energized ^{1 2}

¹ De-energized following automatic reignition failure

² De-energized when **Pilot Off Mode** is set to **Interrupted**

Feature Note

Pilot Off Mode

-  Settings
-  Process Control
-  Configuration

The **Pilot Off Mode** settings allows the user to specify the circumstances at which the pilot valve outputs are to be de-energized to avoid overheating. The Pilot valves will de-energize as follows:

1. **Disabled:** when the process temperature exceeds its configured **High Temp Setpoint**.
2. **Off at Pilot Off Setpoint:** when the process temperature exceeds its configured **Pilot Off Setpoint**
3. **Off at Main Off Setpoint:** when the process temperature exceeds its configured **Main Off Setpoint**
4. **Interrupted:** after successful main light off when monitoring main flame with a UV flame scanner.

4.7 PILOT 2 VALVE SOLENOID OUTPUT

4.7.1 DETAILS

Item	
Terminals	17 & 18
Name	PILOT 2
Type	Powered solenoid valve output with configurable PWM

4.7.2 INTENDED FIELD DEVICE CONNECTIONS

Field Device	Configuration Requirements	Connection Diagrams
Normally Closed Pilot Gas Shutoff Valve - Peak and Hold	Settings > Proc Control > Configuration Pilot Off Mode: As desired Pilot 2: Enabled Minimum Pilots Running: As desired Reignition: As desired Settings > Outputs > Valves Pilot Valve PWM: As desired	Solenoid Output – 12V/24V
	Settings > Proc Control > Configuration Pilot Off Mode: As desired Pilot 2: Enabled Minimum Pilots Running: As desired Reignition: As desired Settings > Outputs > Valves Pilot Valve PWM: 100%	Solenoid Output – 12V/24V
Normally Closed Pilot Gas Shutoff Valve – Constant current	Settings > Proc Control > Configuration Pilot 2: Disabled	N/A

4.7.3 SYSTEM BEHAVIOR



Configuration Details	System State	Pilot 2 Output
Pilot 2: Disabled	Any	De-energized
Pilot 2: Enabled	Power On	De-energized
	Lockout	De-energized
	Alarm	De-energized
	Ready	De-energized
	Waiting	De-energized
	Ignition	Energized
	Pilot	Energized ¹
Main Light Off	Energized ^{1 2}	
Process Control	Energized ^{1 2}	

¹ De-energized following automatic reignition failure

² De-energized when **Pilot Off Mode** is set to **Interrupted**

Feature Note Pilot Reignition

When the **Reignition** setting is **Enabled**, the system will automatically attempt to relight a lost pilot flame provided there is a proven flame on the other pilot. The system will continue to run in its current state; it will keep the lost pilot valve output energized and will energize its associated coil output to attempt a relight. The coil output will remain energized for 2 minutes or until the flame has been successfully re-established, whichever is shorter. If the flame has not been re-established within the 2 minute time limit, the lost pilot valve output and associated coil output will be de-energized and the system will continue to run with a single pilot flame. After this point, the user must manually initiate reignition using (1) the START button on the keypad, or (2) the external ignition switch if a relight is desired. This will cause the system to transition to the Waiting state before proceeding with the ignition sequence. If flame is not detected on at least one pilot at any point during the reignition, the system will abort the reignition sequence and behave as though a flame loss has occurred.

-  Settings
-  Process Control
-  Configuration

Additional Configuration Requirements:
 Settings > Process Control > Configuration > **Pilot 2: Enabled**
 Settings > Process Control > Configuration > **Minimum Pilots Running: 1**

4.8 MAIN VALVE SOLENOID OUTPUTS

4.8.1 DETAILS

Item	
Terminals	19 & 20 and 21 & 22
Name	SSV
Type	Powered solenoid valve output with configurable PWM

4.8.2 INTENDED FIELD DEVICE CONNECTIONS

Field Device	Configuration Requirements	Connection Diagrams
Normally Closed Main Gas Shutoff Valves - Peak and Hold	Settings > Outputs > Valves SSV PWM: As desired	Solenoid Output – 12V/24V
Normally Closed Main Gas Shutoff Valves – Constant current	Settings > Outputs > Valves SSV PWM: 100%	Solenoid Output – 12V/24V

4.8.3 SYSTEM BEHAVIOR

System State	SSV Outputs
Power On	De-energized
Lockout	De-energized
Alarm	De-energized
Ready	De-energized
Waiting	De-energized
Ignition	De-energized
Pilot	De-energized
Main Light Off – before light off attempt	De-energized
Main Light Off – during light off attempt	Energized
Main Light Off – after successful light off	Energized
Process Control	Energized

Upon entry into the Main Light Off state, the SSV outputs remain de-energized until the system (1) proves light off position (if Proof of Light Off input is enabled) and (2) verifies that it is safe to proceed with a main light off attempt. The SSV outputs are then energized to attempt main light off.

4.9 HIGH FIRE VALVE SOLENOID OUTPUT

4.9.1 DETAILS

Item	
Terminals	23 & 24
Name	HIGH FIRE
Type	Powered solenoid valve output with configurable PWM

4.9.2 INTENDED FIELD DEVICE CONNECTIONS

Field Device	Configuration Requirements	Connection Diagrams
Normally Closed Gas Shutoff Valve – Peak and Hold	Settings > Outputs > Valves High Fire Valve PWM: As desired Settings > Proc Control > Configuration Process Control Mode: Staged Heating	Solenoid Output – 12V/24V
Normally Closed Gas Shutoff Valve – Constant current	Settings > Outputs > Valves High Fire Valve PWM: 100% Settings > Proc Control > Configuration Process Control Mode: Staged Heating	Solenoid Output – 12V/24V
Not Used	N/A	N/A

4.9.3 SYSTEM BEHAVIOR

System State	High Fire Valve Output
Power On	De-energized
Lockout	De-energized
Alarm	De-energized
Ready	De-energized
Waiting	De-energized
Ignition	De-energized
Pilot	De-energized
Main Light Off	De-energized
Process Control - Main	De-energized
Process Control – PID Control	De-energized
Process Control - External Firing Rate	De-energized
Process Control – Stage 1	De-energized
Process Control – Stage 2	Energized

4.10 STATUS CONTACT

4.10.1 DETAILS

Item	
Terminals	25 & 27
Name	RUN STATUS
Type	Normally open dry contact

4.10.2 INTENDED FIELD DEVICE CONNECTIONS

Field Device	Configuration Requirements	Connection Diagrams
Site equipment status panel	Settings > Outputs > Status Mode: As desired	Run Status – External AC Source Run Status – External DC Source Run Status – BMS Power
Tank pump motor enable via relay	Settings > Outputs > Status Mode: Level/Flow Control Level/Flow Control Setpoint: As desired	Run Status – Pump Control

4.10.3 STATUS CONTACT BEHAVIOR

System State	Run Status Mode	Heating Status Mode	Low Temp Warning Mode		Level/Flow Control Mode	
			Process Temp Below Low Temp Setpoint	Process Temp Above Low Temp Setpoint	Level/Flow Input Below Level/Flow Control Setpoint	Level/Flow Input Above Level/Flow Control Setpoint
Power On	OPEN	OPEN	OPEN	OPEN	CLOSED	OPEN
Lockout	OPEN	OPEN	OPEN	OPEN	CLOSED	OPEN
Alarm	OPEN	OPEN	OPEN	OPEN	CLOSED	OPEN
Ready	OPEN	OPEN	OPEN	OPEN	CLOSED	OPEN
Waiting	CLOSED	OPEN	OPEN	CLOSED	CLOSED	OPEN
Ignition	CLOSED	CLOSED	OPEN	CLOSED	CLOSED	OPEN
Pilot	CLOSED	CLOSED	OPEN	CLOSED	CLOSED	OPEN
Main Light Off	CLOSED	CLOSED	OPEN	CLOSED	CLOSED	OPEN
Process Control	CLOSED	CLOSED	OPEN	CLOSED	CLOSED	OPEN

Feature Note Run Status Pump Control

The Run Status dry contact **Mode** can be set to **Level/Flow Control** and used to control a pump motor based on a level or flow input to the BMS. The contact behavior depends on the user configured **Run Status Level/Control Setpoint** that is set independently of the Level/Flow setpoints used for process control. The contact remains closed (pump energized) as long as the measured Level/Flow input reading is below the Run Status Level/Control Setpoint and remains open (pump de-energized) as long as the measured Level/Flow input reading is above the **Run Status Level/Control Setpoint** minus the configured **Level/Flow 4-20 Deadband** setting.

-  Settings
-  Outputs
-  Status

Additional Configuration Requirements:
 Settings > Inputs > Level/Flow > **Type**: 4-20
 Settings > Inputs > Level/Flow > **4-20 Span Min/Max**: per transmitter
 Settings > Inputs > Level/Flow > **4-20 Deadband**: as desired

4.11 CONTROLLER POWER INPUT

4.11.1 DETAILS

Item	
Terminals	28, 29, 30, 31, 32
Name	POWER IN
Type	BMS power input

4.11.2 INTENDED FIELD DEVICE CONNECTIONS

Field Device	Configuration Requirements	Connection Diagrams
12V Class 2 Power Supply ¹	Settings > Setup > Commissioning Voltage Setting: 12V Voltage Restart: As desired	Power Input Wiring
24V Class 2 Power Supply ¹	Settings > Setup > Commissioning Voltage Setting: 24V Voltage Restart: As desired	Power Input Wiring

¹ The PF2200 must be powered from a Class 2 circuit as defined in the Canadian Electrical Code (CSA 22.2 No 1-15) or US National Electrical Code (NFPA 70).

Use the Power Diagnostics Screen (System > Diagnostics > Power) to see real time voltage and power consumption numbers.

4.11.3 SYSTEM BEHAVIOR – 12V MODE

System Voltage	Scenario		State Transition if Running	Alerts Pane
		Voltage Restart Setting		
Below 9.5V		Enabled	Waiting	Low Voltage Wait
		Disabled	Lockout	Low Voltage Alarm
Between 9.5V and 10.2V		Any	No effect	Low Voltage Warning
Between 10.2V and 16.2V		Any	No effect	N/A
Between 16.2V and 16.8V		Any	No effect	High Voltage Warning
Above 16.8V		Enabled	Waiting	High Voltage Wait
		Disabled	Lockout	High Voltage Alarm

4.11.4 SYSTEM BEHAVIOR – 24V MODE

System Voltage	Scenario		State Transition if Running	Alerts Pane
		Voltage Restart		
Below 19.0V		Enabled	Waiting	Low Voltage Wait
		Disabled	Lockout	Low Voltage Alarm
Between 19.0V and 20.4V		Any	No effect	Low Voltage Warning
Between 20.4V and 32.4V		Any	No effect	N/A
Between 32.4V and 33.6V		Any	No effect	High Voltage Warning
Above 33.6V		Enabled	Waiting	High Voltage Wait
		Disabled	Lockout	High Voltage Alarm

4.12 EMERGENCY SHUTDOWN INPUT

4.12.1 DETAILS

Item	
Terminals	33 & 34
Name	ESD
Type	Digital input

4.12.2 INTENDED FIELD DEVICE CONNECTIONS

Field Device	Configuration Requirements	Connection Diagrams
External Emergency Stop Pushbutton		Digital Input – Dry Contact
Shutdown signal from PLC	N/A – ESD Input is always enabled	Digital Input – Wet Contact
Plant ESD loop		

4.12.3 SYSTEM BEHAVIOR

ESD Input state	State Transition if running	State Transition if Stopped	Alerts Pane
De-energized	Lockout	Alarm	ESD Contact Open Alarm
Energized	No effect	No effect	N/A

4.13 REMOTE START INPUT

4.13.1 DETAILS

Item	
Terminals	35 & 36
Name	START
Type	Digital input

4.13.2 INTENDED FIELD DEVICE CONNECTIONS

Field Device	Configuration Requirements	Connection Diagrams
Remote Control Panel BMS Start Switch	Settings > Inputs > Remote Start Remote Start: Enabled	Digital Input – Dry Contact Digital Input – Wet Contact
Start signal from PLC	Settings > Inputs > Remote Start Remote Start: Enabled	Digital Input – Dry Contact Digital Input – Wet Contact
Not Used	Settings > Inputs > Remote Start Remote Start: Disabled	N/A

4.13.3 SYSTEM BEHAVIOR

Configuration Details	Event			
	Initial System State	Start Input State	State Transition	Alerts Pane
Remote Start: Enabled	Any	Energized	No effect	N/A
	Any Stopped	De-energized	No effect	Start Contact Open Wait
	Any Running	De-energized	Waiting	Start Contact Open Wait
	Lockout	Energized to de-energized to energized	Ready/Alarm	N/A
	Ready	Energized to de-energized to energized	Startup	N/A
Remote Start: Disabled	Any	Any	No effect	N/A

Toggleing the Remote Start Input from energized to de-energized to energized within 30 seconds will (1) acknowledge on-screen lockout messages and transition the system out of the Lockout state, or (2) start the system if it is in the Ready state.

4.14 AUXILIARY OUTPUTS

4.14.1 DETAILS

Item	
Terminals	37 & 38 and 39 & 40
Name	AUX OUT 1 and AUX OUT 2
Type	4-20mA output

4.14.2 INTENDED FIELD DEVICE CONNECTIONS

Field Device	Configuration Requirements	Connection Diagrams
BMS Temperature input echo to PLC	Settings > Outputs > Aux Mode: As desired Temp Echo Spans: As desired Settings > Setup > Units Temperature: As desired	Analog Output – 4-20mA echo to PLC
BMS input echo to PLC	Settings > Outputs > Aux Mode: As desired Temp Echo Spans: Ignored	Analog Output – 4-20mA echo to PLC
Modbus Register Echo to PLC	Settings > Outputs > Aux Mode: Modbus Echo Temp Echo Spans: Ignored Settings > Setup > Modbus RTU Communication: Enabled All other settings: As desired Modbus Setup: Write desired value (x10) to <i>Remote Echo for Aux Modbus register</i>	Analog Output – 4-20mA echo to PLC

4.14.3 SYSTEM BEHAVIOR

Configuration Details	Aux Out Behavior	Example
Mode: Any Temperature Echo mode	Temperature input value is echoed out on the Aux Output as a 4-20mA signal mapped between the Temp Echo Span values	Mode: Bath Temp Echo Temp Echo Span Min (4mA): 0 °F Temp Echo Span Max (20mA): 100 °F Actual Bath Temperature: 50 °F Aux Output Value: 12mA
Mode: Any BMS input Echo mode	BMS input value is echoed out on the Aux Output as an identical 4-20mA signal	Mode: Level/Flow Echo Actual Level/Flow Input Value: 12mA Aux Output Value: 12mA
Mode: Modbus Echo	Value written to <i>Remote Echo for Aux Modbus register</i> is echoed out on the Aux Output as a 4-20mA signal mapped between 0 and 100%. Note: Written value is interpreted as 10x the intended echo value (i.e. value of 255 written to Modbus register corresponds to a 25.5% output)	Settings > Outputs > Aux Mode: Modbus Echo Settings > Setup > Modbus RTU Communication: Enabled Actual value written to <i>Remote Echo for Aux Modbus register</i> : 500 (50.0%) Aux Output Value: 12mA

Refer to Modbus Configuration Guide for detailed Modbus register information.

4.15 LEVEL/FLOW INPUT

4.15.1 DETAILS

Item	
Terminals	41 & 42
Name	Level/Flow
Type	Configurable digital or 4-20mA input

4.15.2 INTENDED FIELD DEVICE CONNECTIONS

Field Device	Configuration Requirements	Connection Diagrams
Digital level or flow switch	Settings > Inputs > Level/Flow Type: Digital Digital Mode: As desired Level/Flow Delay: As desired All other settings: Ignored System > Customization > Status Priority As desired	Digital Input - Dry Contact Digital Input - Wet Contact
4-20mA level transmitter	Settings > Inputs > Level/Flow Type: 4-20 Digital Mode: Ignored Span Min/Max: Transmitter Min/Max All other settings: As desired Settings > Setup > Units Level: As desired Level/Flow Input Units: Level System > Customization > Status Priority As desired	Analog Input - Loop Powered 4-20mA Transmitter Analog Input - Self Powered 4-20mA Transmitter
4-20mA flow transmitter	Settings > Inputs > Level/Flow Type: 4-20 Digital Mode: Ignored Span Min/Max: Transmitter Min/Max All other settings: As desired Settings > Setup > Units Flow: As desired Level/Flow Input Units: Flow System > Customization > Status Priority As desired	Analog Input - Loop Powered 4-20mA Transmitter Analog Input - Self Powered 4-20mA Transmitter
Not Used	Settings > Inputs > Level/Flow Type: Disabled	N/A

4.15.3 SYSTEM BEHAVIOR

	Configuration Details	Level/Flow Input State	State Transition if Running	Alerts Pane
Type: Digital	Digital Mode: Alarm	De-energized	Lockout	Level/Flow Contact Open Alarm
	Digital Mode: Wait	De-energized	Waiting	Level/Flow Contact Open Wait
	Digital Mode: Warning	De-energized	No effect	Level/Flow Contact Open Warning
	Digital Mode: Any	Energized	No effect	N/A
Type: 4-20	Any	Out of Range	Lockout	Level/Flow Range Alarm
	High Trip Mode: Alarm	High	Lockout	High Level/Flow Alarm
	High Trip Mode: Wait	High	Waiting	High Level/Flow Wait
	High Trip Mode: Warning	High	No effect	High Level/Flow Warning
	Low Trip Mode: Alarm	Low	Lockout	Low Level/Flow Alarm
	Low Trip Mode: Wait	Low	Waiting	Low Level/Flow Wait
	Low Trip Mode: Warning	Low	No effect	Low Level/Flow Warning
	Any	Valid Range	No effect	N/A

4.16 AUXILIARY TEMPERATURE INPUT

4.16.1 DETAILS

Item	
Terminals	43 & 44
Name	AUX TEMP
Type	4-20mA input

4.16.2 INTENDED FIELD DEVICE CONNECTIONS

Field Device	Configuration Requirements	Connection Diagrams
4-20mA Primary Process Temperature Input	<p>Settings > Temps > Aux Mode: Process Control High Temp Setpoint: Per appliance safety requirements 4-20 Span Min/Max: Transmitter Min/Max All other settings: As desired</p> <p>Settings > Proc Control > Configuration Process Control Mode: Aux PID Control* Pilot Off Mode: As desired</p> <p>Settings > Setup > Units Temperature: As desired</p> <p>System > Customization > Status Priority As desired</p> <p>* If Process Control Mode is set to On/Off Control or Staged Heating, then Bath Mode (Settings > Temps > Bath) must be set to High Temp ESD</p>	<p>Analog Input - Loop Powered 4-20mA Transmitter Analog Input - Self Powered 4-20mA Transmitter</p>
4-20mA Secondary Process Temperature Input	<p>Same as above, except: Settings > Proc Control > Configuration Process Control Mode: As desired</p>	<p>Analog Input - Loop Powered 4-20mA Transmitter Analog Input - Self Powered 4-20mA Transmitter</p>
4-20mA High Temperature ESD Input	<p>Settings > Temps > Aux Mode: High Temp ESD High Temp Setpoint: As desired All other Setpoints: Ignored</p> <p>Settings > Setup > Units Temperature: As desired</p> <p>System > Customization > Status Priority As desired</p>	<p>Analog Input - Loop Powered 4-20mA Transmitter Analog Input - Self Powered 4-20mA Transmitter</p>
Display Only 4-20mA Temperature Input	<p>Settings > Temps > Aux Mode: Display Only All other Setpoints: Ignored</p> <p>Settings > Setup > Units Temperature: As desired</p> <p>System > Customization > Status Priority As desired</p>	<p>Analog Input - Loop Powered 4-20mA Transmitter Analog Input - Self Powered 4-20mA Transmitter</p>

4.16.3 SYSTEM BEHAVIOR

Temperature Reading	State transition when running for each Aux Temp Input Mode			
	Process Control	High Temp ESD	Display Only	Disabled
Out of Range	Lockout	Lockout	No effect*	No effect
Above High Temp Setpoint	Lockout	Lockout	No effect	No effect
Below High Temp Setpoint and Above Pilot Off Setpoint		No effect	No effect	No effect
Below Pilot Off Setpoint and Above Main Off Setpoint	Refer to Operating Sequence Section for	No effect	No effect	No effect
Below Main Off Setpoint and Above Process Setpoint	state specific behavior	No effect	No effect	No effect
Below Process Setpoint and Above Low Temp Setpoint		No effect	No effect	No effect
Below Low Temp Setpoint		No effect	No effect	No effect

* Out of Range warning displayed in Alerts Pane

4.17 AUXILIARY INPUTS

4.17.1 DETAILS

Item

Terminals	45 & 46 and 47 & 48
Name	AUX IN 1 and AUX IN 2
Type	Configurable digital or 4-20mA inputs

4.17.2 INTENDED FIELD DEVICE CONNECTIONS

Field Device	Configuration Requirements	Connection Diagrams
Digital input switch	Settings > Inputs > Aux 1/2 Type: Digital Digital Trip Mode: As desired All other settings: Ignored System > Customization > Status Priority As desired	Digital Input – Dry Contact Digital Input – Wet Contact
4-20mA input transmitter	Settings > Inputs > Aux 1/2 Type: 4-20 4-20 Mode: High/Low Trip Digital Trip Mode: Ignored 4-20 Span Min/Max: Transmitter Min/Max All other settings: As desired Settings > Setup > Units Aux In 1/2: As desired System > Customization > Status Priority As desired	Analog Input - Loop Powered 4-20mA Transmitter Analog Input – Self Powered 4-20mA Transmitter Analog Input – Input from PLC
4-20mA flame quality output from UV scanner	Settings > Inputs > Aux 1/2 Type: 4-20 4-20 Mode: UV Flame Quality All other settings: Ignored System > Customization > Status Priority As desired	UV Flame Scanner Wiring
External Firing rate input from PLC	Settings > Inputs > Aux 1/2 Type: 4-20 4-20 Mode: Appliance Firing Rate All other settings: Ignored Settings > Proc Control > Configuration Process Control Mode: External Firing Rate System > Customization > Status Priority As desired	Analog Input – Input from PLC
External Bath ¹ Setpoint adjustment input from PLC	Settings > Inputs > Aux 1/2 Type: 4-20 4-20 Mode: Bath ¹ Process SP Adjust 4-20 Span Min/Max: As desired All other settings: Ignored Settings > Temps > Bath¹ Mode: Process Control Settings > Setup > Units Aux In X: Temperature System > Customization > Status Priority As desired	Analog Input – Input from PLC
Not Used	Settings > Inputs > Aux 1/2 Type: Disabled	N/A



¹ Aux Input can also be configured as a setpoint adjustment input for the Outlet or Aux Temp inputs as well. Refer to appropriate settings for each.

4.17.3 SYSTEM BEHAVIOR

	Configuration Details	Aux In Input State	State Transition if Running	Alerts Pane
Type: Digital	Digital Mode: Alarm	De-energized	Lockout	Aux In Contact Open Alarm
	Digital Mode: Wait	De-energized	Waiting	Aux In Contact Open Wait
	Digital Mode: Warning	De-energized	No effect	Aux In Contact Open Warning
	Digital Mode: Main Permissive	De-energized	Pilot – from main fuel state No effect otherwise	Aux In Contact Open Main Permissive
	Digital Mode: Any	Energized	No effect	N/A
Type: 4-20 Mode: High/Low Trip	High Trip Mode: Alarm	Too high	Lockout	Aux In High Trip Alarm
	High Trip Mode: Wait	Too high	Waiting	Aux In High Trip Wait
	High Trip Mode: Warning	Too high	No effect	Aux In High Trip Warning
	High Trip Mode: Main Permissive	Too high	Pilot – from main fuel state No effect otherwise	Aux In High Trip Main Permissive
	Low Trip Mode: Alarm	Too low	Lockout	Aux In Low Trip Alarm
	Low Trip Mode: Wait	Too low	Waiting	Aux In Low Trip Wait
	Low Trip Mode: Warning	Too low	No effect	Aux In Low Trip Warning
	Low Trip Mode: Main Permissive	Too low	Pilot – from main fuel state No effect otherwise	Aux In Low Trip Main Permissive
Type: 4-20	Any	Out of Range	Lockout	Aux In Range Alarm
Mode: Any	Any	Valid Range	No effect	N/A

Feature Note
Process Setpoint Adjustment Input

Configuring the **Aux In 4-20 Mode** setting as **Process SP Adjust** allows a process setpoint to be updated remotely from an external 4-20mA signal. This can be used for applications that require seasonal setpoint adjustments or other process temperature compensation. The Process Setpoint Adjust input can change the configured **Process Setpoint** of a desired temperature input between its configured **Low Temp Setpoint** and **Main Off Setpoint**. A 4mA input signal corresponds to the configured **Aux In 4-20 Span Min** setting and a 20mA input signal corresponds to the configured **Aux In 4-20 Span Max** setting. The Process Setpoint will be clamped between the configured **Low Temp Setpoint** and **Main Off Setpoint** regardless of the setpoint adjustment input signal (e.g. All setpoint adjustment signals below the configured **Low Temp Setpoint** will change the **Process Setpoint** to match the **Low Temp Setpoint**.)

-  Settings
-  Inputs
-  Aux In 1/Aux In 2

4.18 UV FLAME DETECTION INPUTS

4.18.1 DETAILS

Item	
Terminals	49, 50, 51, 52
Name	UV SCANNER
Type	Digital inputs

4.18.2 INTENDED FIELD DEVICE CONNECTIONS

Field Device	Configuration Requirements	Connection Diagrams
UV main flame scanner	Settings > Proc Control > Configuration UV Flame Detect Mode: Main Only Pilot Off Mode: As desired Settings > Inputs > Aux 1/2 Configure for UV flame quality if desired System > Customization > Status Priority As desired	UV Flame Scanner Wiring
UV pilot and main flame scanner	Settings > Proc Control > Configuration UV Flame Detect Mode: Pilot and Main Pilot Off Mode: Interrupted Pilot 2: Disabled Settings > Inputs > Aux 1/2 Configure for UV flame quality if desired System > Customization > Status Priority As desired	UV Flame Scanner Wiring
Not Used	Settings > Proc Control > Configuration UV Flame Detect Mode: Disabled	N/A

The PF2200-SB supports flame scanners with digital outputs for (1) device fault, (2) flame presence detected and (3) flame absence detected. The flame failure response time of the flame scanner must be 3 seconds or less to ensure that the overall UV flame failure response time of the system is within 4 seconds. A 4-20mA flame quality output is optional. The following UV flame scanners are approved for use with the PF2200-SB:

1. Fireye 65UV5-1004E
2. Zeeco ZPF-120 *

* Zeeco ZPF-120 scanner does not have a separate fault output. Internal faults are conveyed as a mismatch on the Flame On and Flame Off outputs. When using this scanner, the UV PWR output and UV Fault input (terminals 49 and 50) must be shorted together with a jumper. Note that a scanner fault will be annunciated in the Alerts Pane as a UV Flame Detect Mismatch.

4.18.3 SYSTEM BEHAVIOR – UV FAULT INPUT

UV Fault Input state	State Transition if running	State Transition if Stopped	Alerts Pane
De-energized	Lockout	Alarm	UV Flame Detect Fault Alarm
Energized	No effect	No effect	N/A

4.18.4 SYSTEM BEHAVIOR – UV FLAME ON AND FLAME OFF INPUTS

UV Flame On Input state	UV Flame Off Input State	System Interpretation	State Transition if Running	State Transition if Stopped	Alerts Pane
De-energized	De-energized	Mismatch	Lockout	Alarm	UV Flame Detect Mismatch Alarm
Energized	Energized	Mismatch	Lockout	Alarm	N/A
De-energized	Energized	UV flame absent	Refer to Operating Sequence Section		N/A
Energized	De-energized	UV flame present	for state specific behavior		N/A

4.19 PILOT IGNITION I/O

4.19.1 DETAILS

Item	
Terminals	53, 54, 55, 56 and 57, 58, 59, 60
Name	PILOT 1 ION/COIL and PILOT 2 ION/COIL
Type	ION – Ionization flame detection signal utilizing flame rectification COIL – Powered ignition output

4.19.2 INTENDED FIELD DEVICE CONNECTIONS

Field Device	Configuration Requirements	Connection Diagrams
Profire Ignition Coil	Settings > Proc Control > Ignition Mode: Coil	Single Rod Ignition Wiring Dual Rod Ignition Wiring
	Settings > Proc Control > Configuration Pilot 2: As desired	
Separate ignition module with DC input	Settings > Proc Control > Ignition Mode: HEI	Dual Rod Ignition Wiring
	Settings > Proc Control > Configuration Pilot 2: As desired	

4.19.3 SYSTEM BEHAVIOR – COIL OUTPUTS

Configuration Details	System State	Coil 1 Output Behavior	Coil 2 Output Behavior
Mode: Coil	Ignition	Energized - Pulsed	De-energized ²
	Any other state	De-energized ¹	De-energized ²
Mode: HEI	Ignition	Energized - Steady	De-energized ²
	Any other state	De-energized ¹	De-energized ²

¹ Energized under Reignition conditions when **Reignition** setting is **Enabled**

² Follows behavior of Coil 1 output when **Pilot 2** is **Enabled**

4.19.4 SYSTEM BEHAVIOR – IONIZATION INPUTS

Flame Voltage Readings	System Interpretation	
Strength	Greater than 800 mV	Strong Flame Detected
	Between 400 mV and 800 mV	Weak Flame Detected
	Less than 400 mV	No Flame Detected
DC High	Above 2500 mV	Flame Voltage is within acceptable range
	Below 2500 mV	Flame Voltage Fault
AC	Above 500 mV _{pk-pk}	Flame Load Monitor Check passed
	Below 500 mV _{pk-pk}	Flame Load Monitor Check failed

Check the Flame Diagnostics Screen (System > Diagnostics > Flame) to see real-time flame strength and voltage readings.

4.19.5 SYSTEM BEHAVIOR – FLAME DETECTION

Configuration Details	Pilot 1 Flame Presence	Pilot 2 Flame Presence	System Interpretation
Pilot 2: Disabled	Present	Any	Pilot flame present
	Absent	Any	Pilot flame absent
Pilot 2: Enabled	Present	Any	Pilot flame present
	Any	Present	Pilot flame present
Minimum Pilots Running: 1	Absent	Absent	Pilot flame absent
	Present	Present	Pilot flame present
Pilot 2: Enabled	Absent	Any	Pilot flame absent
	Any	Absent	Pilot flame absent

4.20 EXTERNAL IGNITION SWITCH INPUT

4.20.1 DETAILS

Item

Terminals	PWR, IGN, RUN
Name	SWITCH
Type	Digital input

4.20.2 INTENDED FIELD DEVICE CONNECTIONS

Field Device	Configuration Requirements	Connection Instructions
Profire PF2200 Ignition Switch	N/A – Always enabled	Connect factory wired switch connector to BMS Switch terminal header.
Not Used	N/A – Always enabled	Add wire jumper between Switch PWR and RUN terminals

4.20.3 SYSTEM BEHAVIOR

Initial Burner state	External Switch Position	State Transition	Alerts Pane
Any	Run	No effect	N/A
Any	Ignite for less than 1s	No effect	N/A
Ready	Ignite for more than 1s	Startup	N/A
Any fuel state	Ignite for more than 1s	Waiting	Purging Wait
Any non-running state	Ignite for more than 5s	Alarm	External Switch Stuck Alarm
Any running state	Ignite for more than 5s	Lockout	External Switch Stuck Alarm
Any non-running state	Stop	Alarm	User Stop via External Switch Alarm
Any running state	Stop	Lockout	User Stop via External Switch Alarm
Lockout	Run to Stop to Run	Ready/Alarm	N/A

Toggling the External Ignition Switch from Run position to Stop position to Run position within 30 seconds will acknowledge on-screen lockout messages and transition the system out of the Lockout state. Toggling the External Ignition Switch to the Ignite position while in a fuel state will transition the system to the Waiting state and initiate pilot reignition. This is useful upon loss of a single pilot flame when controlling a dual pilot application; the pilots can be reignited without stopping the system.

4.21 BATH TEMPERATURE INPUT

4.21.1 DETAILS

Item

Terminals	61, 62, 63 and 64, 65, 66
Name	BATH
Type	Configurable Type K Thermocouple or PT-100 RTD temperature input

4.21.2 INTENDED FIELD DEVICE CONNECTIONS

Field Device	Configuration Requirements	Connection Diagrams
Type K Thermocouple installed in Appliance Bath (Grounded or Ungrounded)	<p>Settings > Temps > Bath Type: TC Input: As desired ¹ All other settings: As desired</p> <p>Settings > Proc Control > Configuration Process Control Mode: As desired Pilot Off Mode: As desired</p> <p>Settings > Setup > Units Temperature: As desired</p> <p>System > Customization > Status Priority As desired</p>	<p>Temperature Input- Dual Type K Thermocouple Temperature Input- Single Type K Thermocouple</p>
PT100 RTD installed in Appliance Bath	<p>Settings > Temps > Bath Type: RTD Input: As desired ¹ All other settings: As desired</p> <p>Settings > Proc Control > Configuration Process Control Mode: As desired Pilot Off Mode: As desired</p> <p>Settings > Setup > Units Temperature: As desired</p> <p>System > Customization > Status Priority As desired</p>	<p>Temperature Input- Dual 3-Wire RTD Temperature Input- Single 3-wire RTD</p>



¹ Bath Input mode is required to be set to Dual if the Bath Input is specified as a safety function.

4.21.3 SYSTEM BEHAVIOR

Temperature Reading	State transition when running for each Bath Input Mode	
	Process Control	High Temp ESD
Open/Out of Range	Lockout	Lockout
Short in RTD Mode	Lockout	Lockout
Above High Temp Setpoint	Lockout	Lockout
Below High Temp Setpoint and Above Pilot Off Setpoint		No effect
Below Pilot Off Setpoint and Above Main Off Setpoint	Refer to Operating Sequence Section for state specific behavior	No effect
Below Main Off Setpoint and Above Process Setpoint		No effect
Below Process Setpoint and Above Low Temp Setpoint		No effect
Below Low Temp Setpoint		No effect

Feature Note Bath Standby Mode

The **Bath Standby Mode** setting can be **Enabled** to allow the system to remain in a main fuel state to maintain a configured minimum bath temperature, even after a process temperature reading (other than Bath) has exceeded its configured Process Setpoint. As long as (1) the Bath temperature is below its configured Standby Setpoint, and (2) all other process temperatures remain below their configured Main Off Setpoints, the system can remain in a main fuel state to continue to heat the bath. This feature is only available when the **Process Control Mode** is set to **On/Off Control**.

-  Settings
-  Process Control
-  Configuration

Additional Configuration Requirements:
Settings > Temps > Bath > **Standby Setpoint**: As desired
Settings > Temps > Outlet and/or Aux > **Mode**: Process Control

4.22 OUTLET TEMPERATURE INPUT

4.22.1 DETAILS

Item	
Terminals	67, 68, 69
Name	OUTLET
Type	Configurable Type K Thermocouple or PT-100 RTD temperature input

4.22.2 INTENDED FIELD DEVICE CONNECTIONS

Field Device	Configuration Requirements	Connection Diagrams
Single Element Type K Thermocouple installed at Appliance Outlet (Grounded or Ungrounded)	Settings > Temps > Outlet Type: TC Mode: As desired Settings > Setup > Units Temperature: As desired System > Customization > Status Priority As desired	Temperature Input- Single Type K Thermocouple
Single Element PT100 RTD installed at Appliance Outlet	Settings > Temps > Outlet Type: RTD Mode: As desired Settings > Setup > Units Temperature: As desired System > Customization > Status Priority As desired	Temperature Input- Single 3-wire RTD
Not Used	Settings > Temps > Outlet Mode: Disabled	N/A

4.22.3 SYSTEM BEHAVIOR

Temperature Reading	State transition when running for each Outlet Input Mode			
	Process Control	High Temp ESD	Display Only	Disabled
Open/Out of Range	Lockout	Lockout	No effect*	No effect
Short in RTD Mode	Lockout	Lockout	No effect	No effect
Above High Temp Setpoint	Lockout	Lockout	No effect	No effect
Below High Temp Setpoint and Above Pilot Off Setpoint		No effect	No effect	No effect
Below Pilot Off Setpoint and Above Main Off Setpoint		No effect	No effect	No effect
Below Main Off Setpoint and Above Process Setpoint	Refer to Operating Sequence Section for state specific behavior	No effect	No effect	No effect
Below Process Setpoint and Above Low Temp Setpoint		No effect	No effect	No effect
Below Low Temp Setpoint		No effect	No effect	No effect

* Out of Range warning displayed in Alerts Pane

4.23 STACK TEMPERATURE INPUT

4.23.1 DETAILS

Item	
Terminals	70, 71, 72
Name	STACK
Type	Configurable Type K Thermocouple or PT-100 RTD temperature input

4.23.2 INTENDED FIELD DEVICE CONNECTIONS

Field Device	Configuration Requirements	Connection Diagrams
Single Element Type K Thermocouple installed in Appliance Stack (Grounded or Ungrounded)	Settings > Temps > Stack Type: TC Mode: As desired Settings > Setup > Units Temperature: As desired System > Customization > Status Priority As desired	Temperature Input- Single Type K Thermocouple
Single Element PT100 RTD installed in Appliance Stack	Settings > Temps > Stack Type: RTD Mode: As desired Settings > Setup > Units Temperature: As desired System > Customization > Status Priority As desired	Temperature Input- Single 3-wire RTD
Not Used	Settings > Temps > Stack Mode: Disabled	N/A

4.23.3 SYSTEM BEHAVIOR

Temperature Reading	State transition when running for each Stack Input Mode		
	High Temp ESD	Display Only	Disabled
Open/Out of Range	Lockout	No effect*	No effect
Short in RTD Mode	Lockout	No effect	No effect
Above High Temp Setpoint	Lockout	No effect	No effect
Below High Temp Setpoint	No effect	No effect	No effect

* Out of Range warning displayed in Alerts Pane

5 OPERATING SEQUENCE

The PF2200-SB utilizes a state-based control scheme to safely monitor and control a burner. Each system state has specific entry and exit requirements and defined output behavior. The sections below outline the system transitions, output behavior and configuration settings related to each system state.

The current system state is always displayed in the Status Bar located at the top of the User Interface screen.

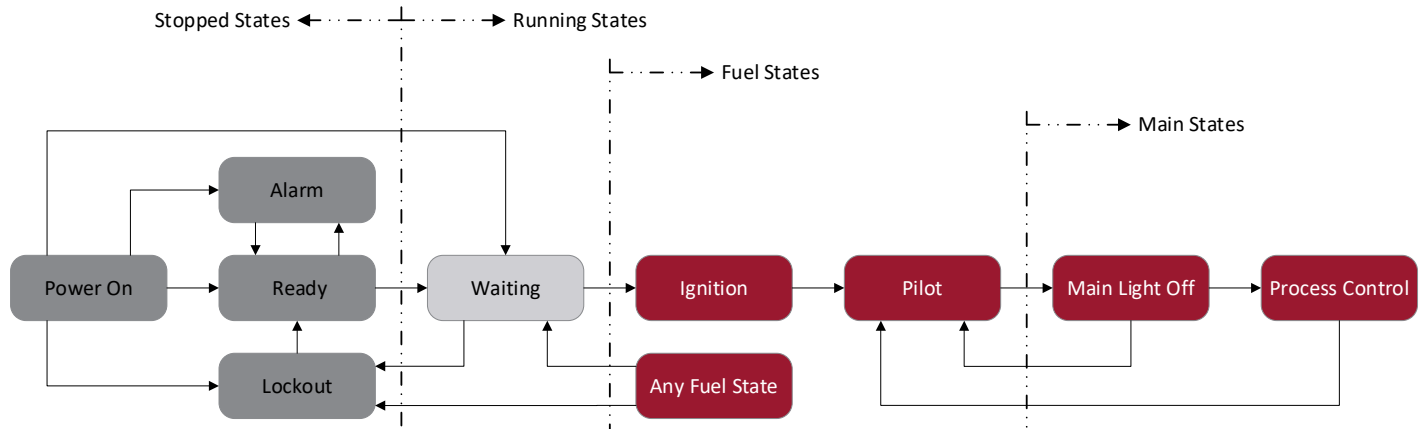

State Name	Stopped State	Running State	Fuel State	Main State	Safety Outputs		
					Coil	Pilot	SSV
Power On	YES	NO	NO	NO	De-energized	De-energized	De-energized
Alarm	YES	NO	NO	NO	De-energized	De-energized	De-energized
Ready	YES	NO	NO	NO	De-energized	De-energized	De-energized
Lockout	YES	NO	NO	NO	De-energized	De-energized	De-energized
Waiting	NO	YES	NO	NO	De-energized	De-energized	De-energized
Ignition	NO	YES	YES	NO	Energized	Energized	De-energized
Pilot	NO	YES	YES	NO	De-energized ¹	Energized	De-energized
Main Light Off - Main Startup Checks	NO	YES	YES	YES	De-energized ¹	Energized ²	De-energized
Main Light Off - Main Delay	NO	YES	YES	YES	De-energized ¹	Energized ²	Energized
Process Control	NO	YES	YES	YES	De-energized ¹	Energized ²	Energized

¹ Coil outputs can be energized in this state upon flame loss when **Reignition** setting is **Enabled**

² Pilot outputs are de-energized in this state when **Pilot Off Mode** is set to **Interrupted**

Alert types displayed in the Alerts Pane on the Status Screen:

- Alarm** – Prevents the system from entering any running state.
- Wait** – Prevents the system from entering any fuel state.
- Main Permissive** – Prevents the system from entering any main fuel state.
- Warning** – Displayed on screen only - does not affect system state.

5.1 POWER ON STATE

The Power On state is the default state of the system upon initial power up. All safety outputs are de-energized and a purge event is triggered when entering the state.

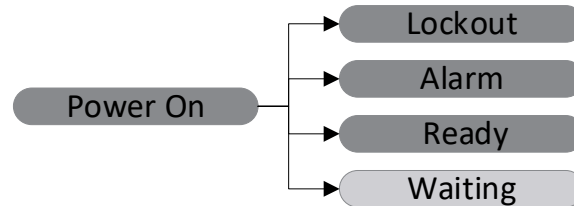

5.1.1 POWERED OUTPUT BEHAVIOR IN THE POWER ON STATE

Output	Behavior
Coil 1 Output	De-energized
Coil 2 Output	De-energized
Pilot 1 Valve Output	De-energized
Pilot 2 Valve Output	De-energized
Main SSV Outputs	De-energized
High Fire Valve Output	De-energized
TCV Output	Purge Position

5.1.2 TRANSITIONS TO THE POWER ON STATE

From	Scenario	Condition
Power Off	System has just powered up	Any

5.1.3 TRANSITIONS FROM THE POWER ON STATE

To	Scenario	Condition
Lockout	Any	Unacknowledged lockout message present at last power down
Alarm	Any	Alarm condition present
Ready	Burner was not running at last power down	Voltage Restart setting Enabled , AND No alarm condition present
	Any	Voltage Restart setting Disabled , AND No alarm condition present
Waiting	System was running at last power down	Voltage Restart setting Enabled , AND No alarm condition present

The Voltage Restart setting dictates whether a running system will be automatically restarted following a power loss event. The system will only restart automatically if there are no alarms present and the Power On purge cycle has been completed.

5.1.4 RELATED SETTINGS - POWER ON STATE

Setting	Navigation
Voltage Restart	Settings > Setup > Commissioning
Purge Time	Settings > Proc Control > Timing

5.2 LOCKOUT STATE

The Lockout state holds all safety outputs in the de-energized position, triggers a purge and prevents the system from entering any other state until the user acknowledges an on-screen lockout message.

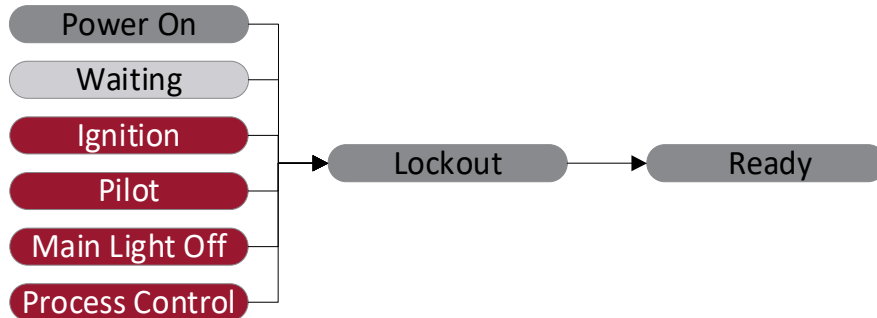

5.2.1 POWERED OUTPUT BEHAVIOR IN THE LOCKOUT STATE

Output	Behavior
Coil 1 Output	De-energized
Coil 2 Output	De-energized
Pilot 1 Valve Output	De-energized
Pilot 2 Valve Output	De-energized
Main SSV Outputs	De-energized
High Fire Valve Output	De-energized
TCV Output	Purge Position

5.2.2 TRANSITIONS TO THE LOCKOUT STATE

From	Scenario	Condition
Power On	System has just powered up	Lockout message present at last power down
Waiting	Any	Alarm condition present
	System stopped by user	Any
	Flame Detected	Any
Ignition	Any	Alarm condition present
	System stopped by user	Any
	Pilot fails to ignite	Ignition attempt limit has been exceeded
Pilot	Any	Alarm condition present
Process Control	System stopped by user	Any
	Flame failure	Relight attempts limit has been exceeded
	Failed to prove light off position	Proof of Light Off Type setting is not Disabled
Main Light Off	Any	Alarm condition present
	System stopped by user	Any
	Flame failure	Relight attempts limit has been exceeded
	Main flame detected before light off	UV Flame Detect Mode is not Disabled

There are 4 ways to stop the system:

1. USER INTERFACE: Press **STOP** then confirm by pressing **OK** or **STOP** again.
 2. START/STOP SWITCH: Turn switch to STOP position.
 3. ESD INPUT: Toggle input to de-energized position.
 4. MODBUS: Write Stop command to the Start/Stop Modbus register.
- Refer to the Modbus Configuration Guide for Modbus register addresses and commands.

5.2.3 TRANSITIONS FROM THE LOCKOUT STATE

To	Scenario	Condition
Ready	Lockout message acknowledged by user	No alarm condition present

There are 4 ways to acknowledge a Lockout:

1. USER INTERFACE: Press **OK** on the keypad.
 2. START/STOP SWITCH: Toggle switch from RUN to STOP to RUN position.
 3. REMOTE START INPUT: Toggle input from energized to de-energized to energized.
 4. MODBUS: Write Acknowledge command to the Clear Shutdown Code Modbus register.
- Refer to the Modbus Configuration Guide for Modbus register addresses and commands.

5.2.4 RELATED SETTINGS – LOCKOUT STATE

Setting	Navigation
Relight Attempts	Settings > Proc Control > Ignition
Purge Time	Settings > Proc Control > Timing
Remote Start	Settings > Inputs > Remote Start
RTU Communication	Settings > Setup > Modbus

5.3 ALARM STATE

The Alarm state is the state to which the system will transition when an alarm is present and the system is not running. The system cannot transition out of the Alarm state until all alarms are cleared. Check the Alerts Pane on the screen to see a list of active alarms.



5.3.1 POWERED OUTPUT BEHAVIOR IN THE ALARM STATE

Output	Behavior
Coil 1 Output	De-energized
Coil 2 Output	De-energized
Pilot 1 Valve Output	De-energized
Pilot 2 Valve Output	De-energized
Main SSV Outputs	De-energized
High Fire Valve Output	De-energized
TCV Output	Purge Position

5.3.2 TRANSITIONS TO THE ALARM STATE

From	Scenario	Condition
Power On	System has just powered up	Alarm condition present
Ready	Any	Alarm condition present

5.3.3 TRANSITIONS FROM THE ALARM STATE

To	Scenario	Condition
Ready	Any	No alarm conditions present

The UI Alerts Pane only displays active alerts - once an alarm condition is cleared, the corresponding alarm is removed from the Alerts Pane. Check the Event Log (System Screen > Logging > Events) for a history of all alarm events.

5.3.4 RELATED SETTINGS – ALARM STATE

Setting	Navigation
Comm Loss Alarm	Settings > Setup > Commissioning

5.4 READY STATE

The Ready state is the state to which the system transitions when all alarm conditions are cleared and the system is safe to start. Users are only able to start the system from the Ready state.

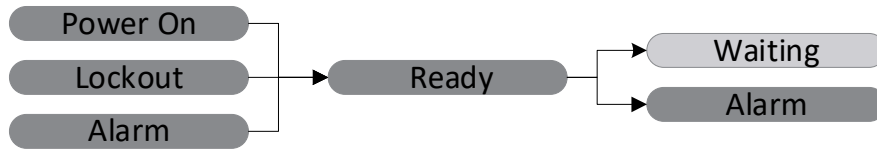

5.4.1 POWERED OUTPUT BEHAVIOR IN THE READY STATE

Output	Behavior
Coil 1 Output	De-energized
Coil 2 Output	De-energized
Pilot 1 Valve Output	De-energized
Pilot 2 Valve Output	De-energized
Main SSV Outputs	De-energized
High Fire Valve Output	De-energized
TCV Output	Purge Position

5.4.2 TRANSITIONS TO THE READY STATE

From	Scenario	Condition
Power On	System has just powered up	No alarm conditions present
Lockout	Lockout message acknowledged by user	No alarm conditions present
Alarm	Alarm condition has been cleared	No additional alarm conditions present

5.4.3 TRANSITIONS FROM THE READY STATE

To	Scenario	Condition
Waiting	Burner started by user	Any
Alarm	Any	Alarm condition present

There are 4 ways to start a burner from the Ready state:

1. USER INTERFACE: Press **START** and confirm start by pressing **OK**.
 2. START/STOP SWITCH: Turn switch to the Ignite position and hold for 1 second.
 3. REMOTE START INPUT: Toggle input from energized to de-energized to energized.
 4. MODBUS: Write Start command to the Start Stop Modbus register.
- Refer to the Modbus Configuration Guide for register addresses and commands.

5.4.4 RELATED SETTINGS – READY STATE

Setting	Navigation
Remote Start	Settings > Inputs > Remote Start
RTU Communication	Settings > Setup > Modbus

5.5 WAITING STATE

The Waiting state is the only running state that does not admit fuel to the burner. The system will automatically trigger a purge when entering the Waiting state from a fuel state. The burner will only proceed to the Ignition state when all wait conditions are cleared.

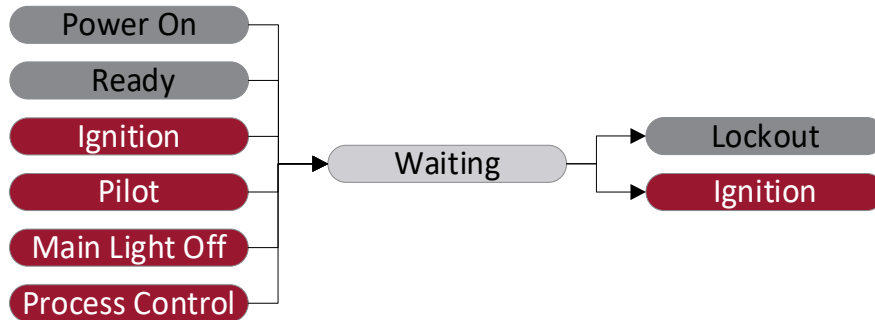

5.5.1 POWERED OUTPUT BEHAVIOR IN THE WAITING STATE

Output	Behavior
Coil 1 Output	De-energized
Coil 2 Output	De-energized
Pilot 1 Valve Output	De-energized
Pilot 2 Valve Output	De-energized
Main SSV Outputs	De-energized
High Fire Valve Output	De-energized
TCV Output	Purge Position

5.5.2 TRANSITIONS TO THE WAITING STATE

From	Scenario	Condition
Power On	System was running at last power down	Voltage Restart setting Enabled , AND No alarm condition present
Ready	System started by user	Any
Ignition	Any	Wait condition is present
	Pilot fails to ignite	Ignition attempt limit not yet exceeded
Pilot	Flame failure	Relight attempts limit not yet exceeded
Main Light Off	Any	Wait condition present
Process Control	Flame is lost on one Pilot AND Reignition command issued by the user	Flame Failure Reignition Time has elapsed AND Minimum Pilots Running is set to 1
Main Light Off	Process Temperature is too high AND Main valves are energized	Pilot Off Mode is set to Interrupted
Process Control	Main valves are energized	Pilot Off Mode is set to Interrupted AND Main Permissive condition is present

Upon loss of a single pilot flame in any fuel state when **Pilot 2** is **Enabled** and **Minimum Pilots Running** is set to **1**, the user can initiate reignition of the lost pilot by pressing **START** and acknowledging the relight confirmation message or by toggling the external ignition switch to the Ignite position. The system will then transition to the Waiting state and attempt to relight both pilots. If the **Reignition** setting is **Enabled**, the system will automatically attempt to relight the lost Pilot (for 2 minutes) without transitioning to the Waiting state.

5.5.3 TRANSITIONS FROM THE WAITING STATE

To	Scenario	Condition
Lockout	Any	Alarm condition present
Ignition	System has been started	All waits have been cleared

5.5.4 RELATED SETTINGS – WAITING STATE

Setting	Navigation
Voltage Restart	Settings > Setup > Commissioning
Relight Attempts	Settings > Proc Control > Ignition
Pilot 2	Settings > Proc Control > Configuration
Minimum Pilots Running	Settings > Proc Control > Configuration
Reignition	Settings > Proc Control > Configuration
Purge Time	Settings > Proc Control > Timing

5.6 IGNITION STATE

The Ignition state is the first fuel state in the burner startup sequence. The coil output(s) are energized, then the pilot valve output(s) are energized to attempt to light off the pilot burner(s). Successful pilot ignition is required before the burner can transition into any other fuel state.



5.6.1 POWERED OUTPUT BEHAVIOR IN THE IGNITION STATE

Output	Behavior
Coil 1 Output	Energized
Coil 2 Output	De-energized*
Pilot 1 Valve Output	Energized
Pilot 2 Valve Output	De-energized*
Main SSV Outputs	De-energized
High Fire Valve Output	De-energized
TCV Output	Pilot Position

* Energized when **Pilot 2** is **Enabled**

If **Pilot 2** is **Enabled** and **Minimum Pilots Running** is set to **2**, successful pilot ignition requires flame to be established on both Pilot 1 and Pilot 2. If **Pilot 2** is **Disabled** or **Minimum Pilots Running** is set to **1**, successful pilot ignition requires flame to be established on one of Pilot 1 or Pilot 2 only.

5.6.2 TRANSITIONS TO THE IGNITION STATE

From	Scenario	Condition
Waiting	System has been started	All waits have been cleared

5.6.3 TRANSITIONS FROM THE IGNITION STATE

To	Scenario	Condition
Lockout & purge	Any	Alarm condition present
	Burner stopped by user	Any
	First Pilot ignition after system start	Pilot ignition fails 3 rd consecutive attempt
	Pilot ignition following flame loss	Ignition attempts exceed Relight Attempts setting
	Flame detected	Ignition sequence has not yet begun
Waiting & purge	Any	Wait condition is present
	Pilot fails to ignite	Ignition attempt limit not yet exceeded
Pilot	Pilot ignition successful	Any

The **Relight Attempts** setting dictates only the number of relight attempts allowed following a flame-loss event. The system can attempt pilot ignition 3 times upon a fresh user start, regardless of the setting value.

5.6.4 RELATED SETTINGS – IGNITION STATE

Setting	Navigation
Relight Attempts	Settings > Proc Control > Ignition
Pilot 2	Settings > Proc Control > Configuration
Minimum Pilots Running	Settings > Proc Control > Configuration

5.7 PILOT STATE

The Pilot state ensures that a reliable pilot flame is established prior to lighting off the main burner. The system can remain in the pilot state when heat demand is low and will transition to a main state when the heat demand increases.



5.7.1 POWERED OUTPUT BEHAVIOR IN THE PILOT STATE

Output	Behavior
Coil 1 Output	De-energized ¹
Coil 2 Output	De-energized ¹
Pilot 1 Valve Output	Energized
Pilot 2 Valve Output	De-energized ²
Main SSV Outputs	De-energized
High Fire Valve Output	De-energized
TCV Output	Pilot Position

¹ Energized under Reignition conditions when **Reignition** setting is **Enabled**

² Energized when **Pilot 2** is **Enabled**

5.7.2 TRANSITIONS TO THE PILOT STATE

From	Scenario	Condition
Ignition	Pilot ignition successful	Any
Main Light Off	Process Temperature is too high	Pilot Off Mode is not set to Interrupted
Process Control	Any	Pilot Off Mode is not set to Interrupted AND Main Permissive condition present

5.7.3 TRANSITIONS FROM THE PILOT STATE

To	Scenario	Condition
Lockout & purge	Any	Alarm condition present
	Burner stopped by user	Any
	Flame failure	Relight attempts limit has been exceeded
	Temperature exceeds High Temp Setpoint	Pilot Off Mode is set to Disabled
Waiting & purge	Flame failure	Relight attempts limit not yet exceeded
	Any	Wait condition present
	Process temperature exceeds Pilot Off Setpoint	Pilot Off Mode is set to Off at Pilot Off Setpoint
	Process temperature exceeds Main Off Setpoint	Pilot Off Mode is set to Off at Main Off Setpoint
Main Light Off	Process temperature is too low	No Main Permissive condition present

After successful pilot flame establishment, the system will hold in the Pilot state for the duration of the user configured **Pilot Startup Delay Time** before it can transition to a main state. This is to warm up the burner and establish a draft prior to lighting off the main burner.

5.7.4 RELATED SETTINGS – PILOT STATE

Setting	Navigation
Relight Attempts	Settings > Proc Control > Ignition
Pilot Startup Delay	Settings > Proc Control > Timing
Pilot Off Mode	Settings > Proc Control > Configuration
Pilot 2	Settings > Proc Control > Configuration
Minimum Pilots Running	Settings > Proc Control > Configuration
Reignition	Settings > Proc Control > Configuration
High Temp Setpoint	Settings > Temps > Bath*
Pilot Off Setpoint	Settings > Temps > Bath*
Main Off Setpoint	Settings > Temps > Bath*

* Outlet and Aux Temp inputs can also be configured for process control. See corresponding settings menu for associated Pilot Off and Main Off Setpoints.

When **UV Flame Detect Mode** (Settings > Proc Control > Configuration) is **Disabled**, the number of allowable relight attempts is reset to the configured **Relight Attempts** value upon successful pilot flame establishment.

5.8 MAIN LIGHT OFF STATE

The Main Light Off state allows for the controlled light off of the main burner before admitting maximum fuel to the burner. The main burner is lit with the TCV at its light off position and then the TCV is held at its minimum position for the duration of the state to allow the burner to heat up gradually before transitioning into the Process control state.



5.8.1 POWERED OUTPUT BEHAVIOR IN THE MAIN LIGHT OFF STATE

Output	Behavior
Coil 1 Output	De-energized ¹
Coil 2 Output	De-energized ¹
Pilot 1 Valve Output	Energized ²
Pilot 2 Valve Output	De-energized ^{2 3}
Main SSV Outputs	De-energized to Energized ⁴
High Fire Valve Output	De-energized
TCV Output	Minimum Position

¹ Energized under Reignition conditions when **Reignition** setting is **Enabled**

² De-energized following energization of Main SSV outputs when **Pilot Off Mode** is set to **Interrupted**

³ Follows behavior of Pilot 1 Valve output when **Pilot 2** is **Enabled**

⁴ Main SSV outputs are de-energized upon entry into the state and held until the system is ready to attempt ignition of the main burner. At this point, the Main SSV outputs are energized.

When the **Proof of Light Off Type** setting is enabled, the system will hold the TCV at the user configurable **Proof of Light Off Setpoint** for the duration of the user configurable **Request Light Off Delay Time** before proceeding with the main ignition attempt. This time is to allow the TCV to move to its light off position prior to the energization of the Main SSV outputs.

5.8.2 TRANSITIONS TO THE MAIN LIGHT OFF STATE

From	Scenario	Condition
Pilot	Process Temperature is too low	No Main Permissive condition present

5.8.3 TRANSITIONS FROM THE MAIN LIGHT OFF STATE

To	Scenario	Condition
Lockout & purge	Any	Alarm condition present
	Burner stopped by user	Any
	Flame failure	Relight attempts limit has been exceeded
	UV Flame Detected before light off attempt	UV Flame Detect Mode is set to Main Only
Waiting & purge	Flame failure	Relight attempts limit not yet exceeded
	Any	Wait condition present
	Process temperature exceeds Main Off Setpoint	Pilot Off Mode is set to Off at Main Off Setpoint
	Main valves de-energized	Main Permissive condition present
Pilot	Main valves energized	Main Permissive condition present AND Pilot Off Mode is set to Interrupted
	Process temperature exceeds Main Off Setpoint	Pilot Off Mode is NOT set to Off at Main Off Setpoint
Process Control	Any	Main Permissive condition present AND Pilot Off Mode is not set to Interrupted Main Startup Delay Time has elapsed

When entering the Main Light Off state following a user start, the burner will hold the TCV at its configured **Min Position** for the duration of the user configurable **Main Startup Delay Time**. If the burner is re-entering the Main Light Off state after having previously been running in Process Control, the **Main Startup Delay Time** is ignored and the burner transitions immediately to the Process control state after igniting the main burner.

5.8.4 RELATED SETTINGS – MAIN LIGHT OFF STATE

Setting	Navigation
Relight Attempts	Settings > Proc Control > Ignition
Request Light Off Delay Time	Settings > Proc Control > Timing
Main Startup Delay Time	Settings > Proc Control > Timing
Pilot Off Mode	Settings > Proc Control > Configuration
UV Flame Detect Mode	Settings > Proc Control > Configuration
Proof of Light Off Type	Settings > Inputs > Proof of Light Off
Proof of Light Off Setpoint	Settings > Inputs > Proof of Light Off
Proof of Light Off Tolerance	Settings > Inputs > Proof of Light Off
TCV Min Position	Settings > Outputs > TCV
Main Off Setpoint*	Settings > Temps > Bath*

* Outlet and Aux Temp inputs can also be configured for process control. See corresponding settings menu for associated Main Off Setpoint.

When **UV Flame Detect Mode** (Settings > Proc Control > Configuration) is set to **Main Only** or **Pilot and Main**, the number of allowable relight attempts is reset to the configured **Relight Attempts** value upon successful main flame establishment.

5.9 PROCESS CONTROL STATES

The Process Control states are the states to which the system transitions when its heat demand is the highest. The system attempts to maintain the process temperature at the user configured Process Setpoint in accordance with the user selected **Process Control Mode**. The Process Control states are:

1. Main
2. Stage 1 and Stage 2
3. PID Control
4. External Firing Rate



5.9.1 MAIN PROCESS CONTROL STATE

Main is the process control state used when the system is configured for On/Off Control. The configuration mode does not utilize the High Fire valve output and does not modulate the Temperature Control Valve (TCV) output.

POWERED OUTPUT BEHAVIOR IN THE MAIN STATE

Output	Behavior
Coil 1 Output	De-energized ¹
Coil 2 Output	De-energized ¹
Pilot 1 Valve Output	Energized ²
Pilot 2 Valve Output	De-energized ^{2,3}
Main SSV Outputs	Energized
High Fire Valve Output	De-energized
TCV Output	100% ⁴

¹ Energized under Reignition conditions when **Reignition** setting is **Enabled**

² De-energized when **Pilot Off Mode** is set to **Interrupted**

³ Follows behavior of Pilot 1 Valve output when **Pilot 2** is **Enabled**

⁴ The TCV output increases to 100% in accordance with the user configured **Output Rate Limit** setting and holds for the duration of the state.

TRANSITIONS TO THE MAIN STATE

From	Scenario	Condition
Main Light Off	Process Temperature is too low	Successful main flame ignition AND Process Control Mode is set to On/Off Control

TRANSITIONS FROM THE MAIN STATE

To	Scenario	Condition
Lockout & purge	Any	Alarm condition present
	Burner stopped by user	Any
	Flame failure	Relight attempts limit has been exceeded
Waiting & purge	Flame failure	Relight attempts limit not yet exceeded
	Any	Wait condition present
	Any	Pilot Off Mode is set to Interrupted AND Main Permissive condition present
	Process temperature exceeds Process Setpoint	Pilot Off Mode is set to Interrupted or Off at Main Off Setpoint
Pilot	Process temperature exceeds Process Setpoint	Pilot Off Mode is not set to Disabled or Off at Pilot Off Setpoint AND Bath Standby Mode is Disabled

Feature Note
On/Off Control

The **Process Control Mode** setting can be set to **On/Off Control** for single stage heat demand applications that do not use a temperature control valve or a high fire valve. The Main Off Setpoint is ignored so the SSV outputs are energized and de-energized about the configured **Process Setpoint**; the system will remain in the Main state with the SSV outputs energized as long as the measured process temperature is below the configured **Process Setpoint**, and will transition to a non-main fuel state when the measured process temperature exceeds the configured **Process Setpoint**. The system will transition back to the Main state when the measured process temperature falls below the configured **Process Setpoint** minus the configured **Deadband** setting.

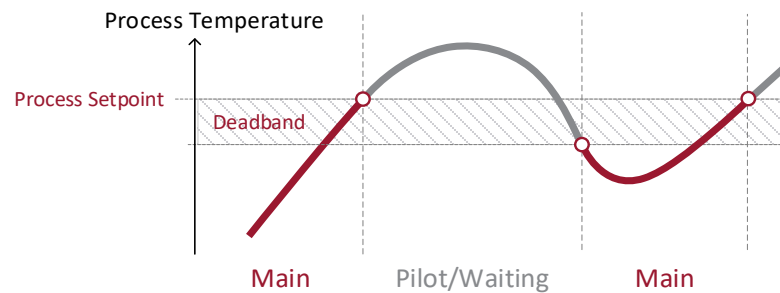

- Settings
- Process Control
- Configuration

RELATED SETTINGS – MAIN STATE

Setting	Navigation
Relight Attempts	Settings > Proc Control > Ignition
Process Control Mode	Settings > Proc Control > Configuration
Pilot Off Mode	Settings > Proc Control > Configuration
Reignition	Settings > Proc Control > Configuration
Bath Standby Mode	Settings > Proc Control > Configuration
Output Rate Limit	Settings > Proc Control > PID Control
Process Setpoint	Settings > Temps > Bath*
Main Off Setpoint	Settings > Temps > Bath*
Bath Standby Setpoint	Settings > Temps > Bath

* Outlet and Aux Temp inputs can also be configured for process control. See corresponding settings menu for associated Main Off Setpoint.

5.9.2 STAGE 1 AND STAGE 2 PROCESS CONTROL STATES

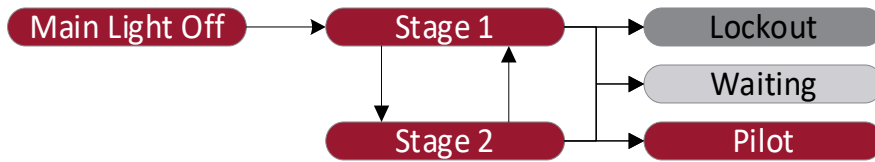

Stage 1 and Stage 2 are the process control states used when the system is configured for Staged Heating applications utilizing the High Fire Valve output.

POWERED OUTPUT BEHAVIOR IN THE STAGE 1 AND STAGE 2 STATE

Output	Stage 1 Behavior	Stage 2 Behavior
Coil 1 Output	De-energized ¹	De-energized ¹
Coil 2 Output	De-energized ¹	De-energized ¹
Pilot 1 Valve Output	Energized ²	Energized ²
Pilot 2 Valve Output	De-energized ^{2 3}	De-energized ^{2 3}
Main SSV Outputs	Energized	Energized
High Fire Valve Output	De-energized	Energized
TCV Output	100%	100%

¹ Energized under Reignition conditions when **Reignition** setting is **Enabled**
² De-energized when **Pilot Off Mode** is set to **Interrupted**
³ Follows behavior of Pilot 1 Valve output when **Pilot 2** is **Enabled**

TRANSITIONS TO THE STAGE 1 STATE

From	Scenario	Condition
Main Light Off	Process Temperature is too low	Successful main flame ignition AND Process Control Mode is set to Staged Heating

TRANSITIONS TO THE STAGE 2 STATE

From	Scenario	Condition
Stage 1	Process Temperature is too low	Any

TRANSITIONS FROM THE STAGE 1 STATE

To	Scenario	Condition
Lockout & purge	Any	Alarm condition present
	Burner stopped by user	Any
	Flame failure	Relight attempts limit has been exceeded
Waiting & purge	Flame failure	Relight attempts limit not yet exceeded
	Any	Wait condition present
	Any	Pilot Off Mode is set to Interrupted AND Main Permissive condition present
Pilot	Process temperature exceeds Main Off Setpoint	Pilot Off Mode is set to Interrupted OR Pilot Off Mode is set to Off at Main Off Setpoint
	Process temperature exceeds Main Off Setpoint	Pilot Off Mode is set to Disabled OR Pilot Off Mode is set to Off at Pilot Off Setpoint
	Any	Pilot Off Mode is not set to Interrupted AND Main Permissive condition present
Stage 2	Process temperature is below Process Setpoint	Any

TRANSITIONS FROM THE STAGE 2 STATE

To	Scenario	Condition
Lockout & purge	Any	Alarm condition present
	Burner stopped by user	Any
	Flame failure	Relight attempts limit has been exceeded
Waiting & purge	Flame failure	Relight attempts limit not yet exceeded
	Any	Wait condition present
	Any	Pilot Off Mode is set to Interrupted AND Main Permissive condition present
Pilot	Any	Pilot Off Mode is not set to Interrupted AND Main Permissive condition present
Stage 1	Process temperature exceeds Process Setpoint	Any

Feature Note
Staged Heating Mode

The **Process Control Mode** setting can be set to **Staged Heating** for tiered heat demand applications that do not use a temperature control valve. Stage 2 is the highest heat demand state (Both SSV and High Fire valve outputs are energized). The system will remain in Stage 2 until the process temperature exceeds the configured **Process Setpoint** and transitions into the Stage 1 state (SSV valve outputs are energized, and High Fire valve output is de-energized). The system will remain in Stage 1 until the process temperature either (1) exceeds the configured **Main Off Setpoint** where it will transition to a non-main fuel state, or (2) drops below the configured **Process Setpoint** minus the configured **Deadband** where it will transition back to Stage 2. Upon exceeding the configured **Main Off Setpoint**, the temperature must fall below the configured **Process Setpoint** minus the configured **Deadband** before the system can transition back into a main fuel state

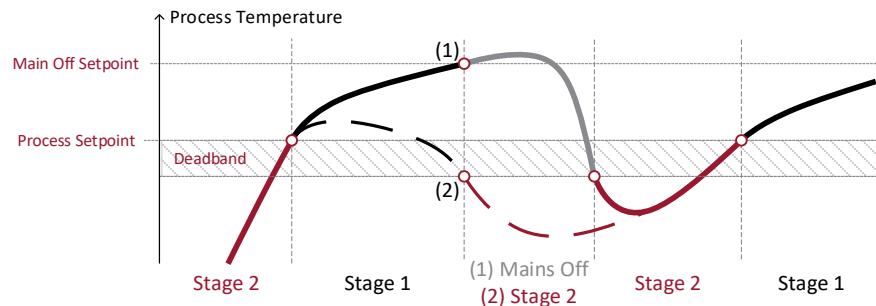

- Settings
- Process Control
- Configuration

RELATED SETTINGS – STAGE 1 AND STAGE 2 STATES

Setting	Navigation
Relight Attempts	Settings > Proc Control > Ignition
Pilot Off Mode	Settings > Proc Control > Configuration
Reignition	Settings > Proc Control > Configuration
Process Setpoint	Settings > Temps > Bath*
Process Deadband	Settings > Temps > Bath*
Main Off Setpoint	Settings > Temps > Bath*

* Outlet and Aux Temp inputs can also be configured for process control. See corresponding settings menu for associated Main Off Setpoint.

5.9.3 PID CONTROL PROCESS CONTROL STATE

PID Control is the process control state used when the system is configured to control the process temperature through the Temperature Control Valve (TCV) output using the internal PF2200 PID algorithms. The state will be used when Process Control Mode is set to any of the following:

1. Bath PID Control
2. Outlet PID Control
3. Aux PID Control
4. Cascaded PID Control

While in PID control, the system will attempt to maintain the process temperature at the process temperature setpoint by modulating the system firing rate via the TCV output.

POWERED OUTPUT BEHAVIOR IN THE PID CONTROL STATE

Output	Behavior
Coil 1 Output	De-energized ¹
Coil 2 Output	De-energized ¹
Pilot 1 Valve Output	Energized ²
Pilot 2 Valve Output	De-energized ^{2 3}
Main SSV Outputs	Energized
High Fire Valve Output	De-energized
TCV Output	Variable

¹ Energized under Reignition conditions when **Reignition** setting is **Enabled**

² De-energized when **Pilot Off Mode** is set to **Interrupted**

³ Follows behavior of Pilot 1 Valve output when **Pilot 2** is **Enabled**

TRANSITIONS TO THE PID CONTROL STATE

From	Scenario	Condition
Main Light Off	Process Temperature is too low	Successful main flame ignition AND Process Control Mode is set to any PID Control mode

TRANSITIONS FROM THE PID CONTROL STATE

To	Scenario	Condition
Lockout & purge	Any	Alarm condition present
	Burner stopped by user	Any
	Flame failure	Relight attempts limit has been exceeded
Waiting & purge	Flame failure	Relight attempts limit not yet exceeded
	Any	Wait condition present
	Any	Pilot Off Mode is set to Interrupted AND Main Permissive condition present
	Process temperature exceeds Main Off Setpoint	Pilot Off Mode is set to Interrupted OR Pilot Off Mode is set to Off at Main Off Setpoint
Pilot	Process temperature exceeds Main Off Setpoint	Pilot Off Mode is set to Disabled OR Pilot Off Mode is set to Off at Pilot Off Setpoint
	Any	Pilot Off Mode is not set to Interrupted AND Main Permissive condition present

RELATED SETTINGS – PID CONTROL STATE

Setting	Navigation
Relight Attempts	Settings > Proc Control > Ignition
Process Control Mode	Settings > Proc Control > Configuration
Pilot Off Mode	Settings > Proc Control > Configuration
Reignition	Settings > Proc Control > Configuration
Process Proportional Band	Settings > Proc Control > PID Control
Process Integral Time	Settings > Proc Control > PID Control
Process Derivative Time	Settings > Proc Control > PID Control
Process Integral Reset Range	Settings > Proc Control > PID Control
Cascade Proportional Band	Settings > Proc Control > PID Control
Cascade Integral Time	Settings > Proc Control > PID Control
Cascade Derivative Time	Settings > Proc Control > PID Control
Cascade Integral Reset Range	Settings > Proc Control > PID Control
Output Rate Limit	Settings > Proc Control > PID Control
Ramp Time	Settings > Proc Control > PID Control
TCV Minimum Position	Settings > Outputs > TCV
Process Setpoint	Settings > Temps > Bath*
Main Off Setpoint	Settings > Temps > Bath*

* Outlet and Aux Temp inputs can also be configured for process control. See corresponding settings menu for associated Main Off Setpoint.

5.9.4 EXTERNAL FIRING RATE PROCESS CONTROL STATE

External Firing Rate is the process control state used when the system is configured to control process temperature through the Temperature Control Valve (TCV) output based on a firing rate input signal from another source.

POWERED OUTPUT BEHAVIOR IN THE EXTERNAL FIRING RATE STATE

Output	Behavior
Coil 1 Output	De-energized ¹
Coil 2 Output	De-energized ¹
Pilot 1 Valve Output	Energized ²
Pilot 2 Valve Output	De-energized ^{2 3}
Main SSV Outputs	Energized
High Fire Valve Output	De-energized
TCV Output	Echoes External Firing Rate Input ⁴

¹ Energized under Reignition conditions when **Reignition** setting is **Enabled**

² De-energized when **Pilot Off Mode** is set to **Interrupted**

³ Follows behavior of Pilot 1 Valve output when **Pilot 2** is **Enabled**

⁴ Output will not go below configured **TCV Minimum Position** setting

TRANSITIONS TO THE EXTERNAL FIRING RATE STATE

From	Scenario	Condition
Main Light Off	Process Temperature is too low	Successful main flame ignition AND Process Control Mode is set to External Firing Rate

TRANSITIONS FROM THE EXTERNAL FIRING RATE STATE

To	Scenario	Condition
Lockout & purge	Any	Alarm condition present
	Burner stopped by user	Any
	Flame failure	Relight attempts limit has been exceeded
Waiting & purge	Flame failure	Relight attempts limit not yet exceeded
	Any	Wait condition present
	Any	Pilot Off Mode is set to Interrupted AND Main Permissive condition present
	Process temperature exceeds Main Off Setpoint	Pilot Off Mode is set to Interrupted OR Pilot Off Mode is set to Off at Main Off Setpoint
Pilot	Process temperature exceeds Main Off Setpoint	Pilot Off Mode is set to Disabled OR Pilot Off Mode is set to Off at Pilot Off Setpoint
	Any	Pilot Off Mode is not set to Interrupted AND Main Permissive condition present

SYSTEM BEHAVIOR – APPLIANCE FIRING RATE

Initial System state	Aux In Firing Rate Input	TCV Output
Any	Out of Range	0%
Any non-Process Control state	Any	Unaffected by Firing rate input
Process Control state	Below TCV Min Position setting	TCV minimum position
	Above TCV Min Position setting	Identical to Firing rate input signal.

RELATED SETTINGS – EXTERNAL FIRING RATE STATE

Setting	Navigation
Relight Attempts	Settings > Proc Control > Ignition
Process Control Mode	Settings > Proc Control > Configuration
Pilot Off Mode	Settings > Proc Control > Configuration
Reignition	Settings > Proc Control > Configuration
TCV Minimum Position	Settings > Outputs > TCV
Aux In 1 Type	Settings > Inputs > Aux 1 ¹
Aux In 1 4-20 Mode	Settings > Inputs > Aux 1 ¹
Process Setpoint	Settings > Temps > Bath ²
Main Off Setpoint	Settings > Temps > Bath ²

¹ External Firing rate input can also be configured on the Aux In 2 input

² Outlet and Aux Temp inputs can also be configured for process control. See corresponding settings menu for associated Main Off Setpoint

6 INSTALLATION



Warning: Installation and modification shall not be performed while the system is energized. Disconnect power source prior to connecting devices or modifying wiring.

Installers and commissioners of the PF2200-SB system must:

- Understand local codes and how they apply to the installation (for both electrical and mechanical aspects of the installation).
- Understand the electrical and mechanical limitations of the product and how that relates to the installation.
- Understand the safety and operational effects of modifying system settings or wiring.
- Verify all required safety functions prior to completing the commissioning of the appliance.
- Be fluent in the English language (the only language this product supports).
- Be familiar with navigating the product menus and modifying settings.

6.1 MOUNTING CONSIDERATIONS

The enclosure should be mounted:

- Upright in such a way that the screen is clearly visible and the keypad is easy to access. Recommended mounting height is 1.5m (5ft) above ground.
- Near to the appliance being controlled in order to minimize cable run lengths to the valve train (solenoids), burner assembly (ignition coil and flame rod) and thermocouple elements.
- In such a way as to avoid direct sunlight exposure on the screen. Extended UV exposure may compromise viewability.
- Such that the enclosure door can be fully opened during maintenance and commissioning.

6.2 CONNECTION DIAGRAMS



Caution: Electrical devices connected to the controller must meet local electrical codes and be within the voltage limits specified in this manual.



Caution: All field wiring must be properly fused and sized in accordance with local codes.



Caution: Wires must be installed such that the connection does not rely on the structural integrity of the wire insulation, and that no more than one conductor is terminated in a single terminal.

6.2.1 DIGITAL INPUT - DRY CONTACT

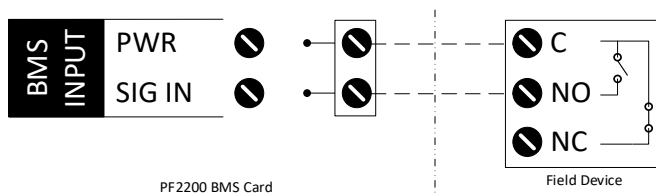

Installation Notes:

1. The BMS uses energized-to-run logic for all digital inputs.
2. PWR terminal output matches system voltage input up to 13.5V.

6.2.2 DIGITAL INPUT - WET CONTACT

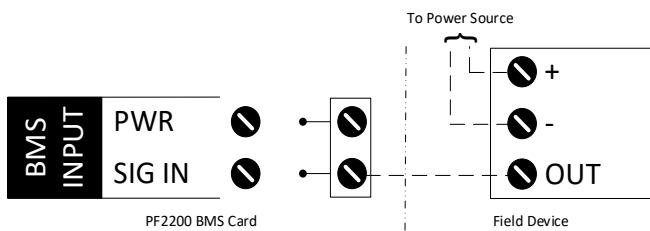

Installation Notes:

1. The BMS uses energized-to-run logic for all digital inputs.
2. External power source must be Earth grounded.
3. External power source must be referenced about BMS card terminal 29 such that the supplied voltage (1) does not exceed 30V_{DC} with reference to BMS Power In -, and (2) does not drop below -0.5V with reference to BMS Power In -.

6.2.3 ANALOG INPUT - LOOP POWERED 4-20mA TRANSMITTER

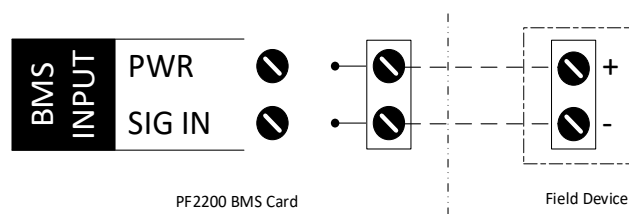

Installation Notes:

1. PWR terminal output matches system voltage input up to 13.5V.

6.2.4 ANALOG INPUT – SELF POWERED 4-20mA TRANSMITTER

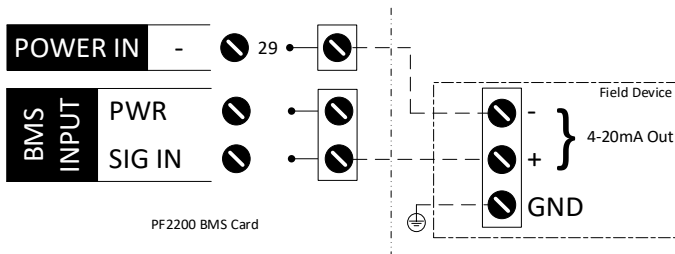

Installation Notes:

1. Field Device must be Earth grounded.
2. Power source must be referenced about BMS card terminal 29 such that the supplied voltage (1) does not exceed 30V_{DC} with reference to BMS Power In -, and (2) does not drop below -0.5V with reference to BMS Power In -.

6.2.5 ANALOG INPUT – INPUT FROM PLC

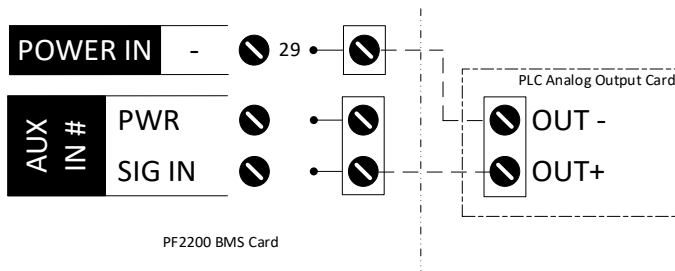

Installation Notes:

1. PLC power source must be referenced about BMS card terminal 29 such that the supplied voltage (1) does not exceed 30V_{DC} with reference to BMS Power In -, and (2) does not drop below -0.5V with reference to BMS Power In -.

6.2.6 TCV OUTPUT WIRING

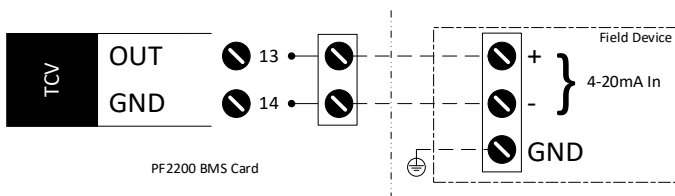

Installation Notes:

1. 4-20mA Input – terminal must be run back to BMS terminal 14 (Local ground) to ensure proper output functionality.

6.2.7 SOLENOID OUTPUT – 12V/24V

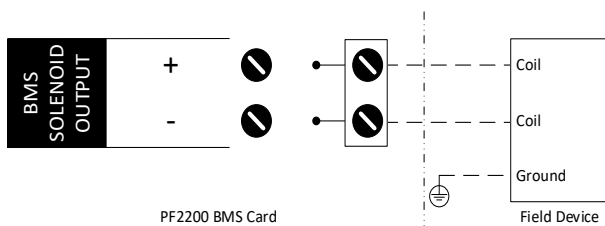

Installation Notes:

1. Solenoid powered outputs are rated to 5A max individually, however the power input to the BMS is fused at 10A. Care must be taken as to not exceed the 10A max input when using multiple high-powered solenoids.
2. Solenoid valve outputs are assumed to be in safe state when de-energized. Normally closed valves must be used such that gas-flow to the burner is stopped when the output is in the de-energized state. Solenoid valve outputs can also be connected to normally open bleed valves when utilizing a double block and bleed configuration.





Caution: Do not connect solenoid device minus (-) terminals to ground, as the BMS solenoid output minus (-) terminals are not grounded.

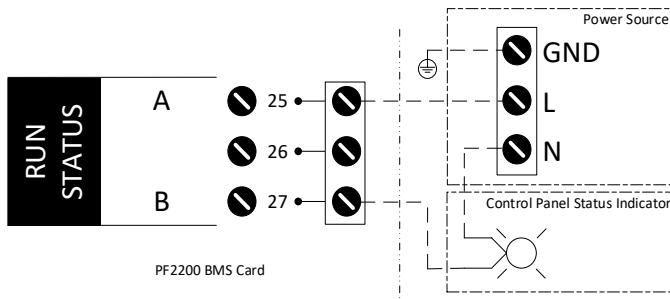

Caution: Do not jumper solenoid minus terminals together under any circumstance, as this will compromise the safety integrity of the system.

6.2.8 RUN STATUS – EXTERNAL AC SOURCE





Warning: 120VAC wiring should be installed by a qualified electrician.

6.2.9 RUN STATUS – EXTERNAL DC SOURCE

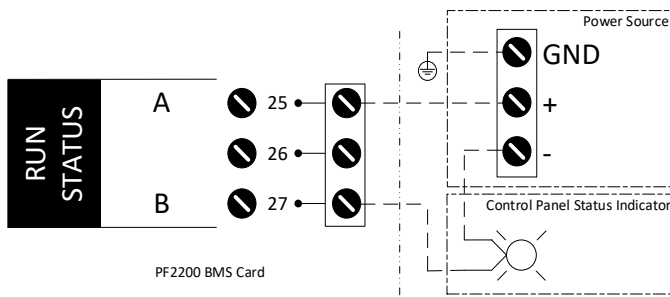

6.2.10 RUN STATUS – BMS POWER

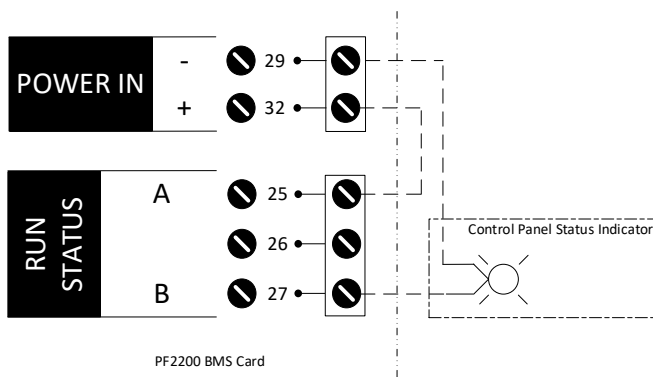

6.2.11 RUN STATUS – PUMP CONTROL

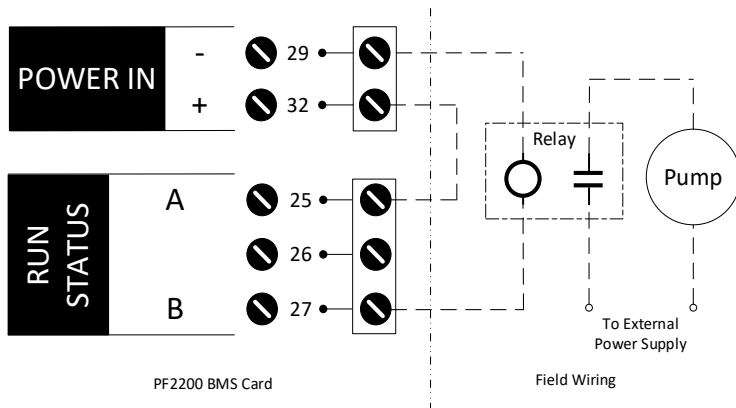

Installation Notes:

1. A relay must be used to isolate the Run Status contact from high-transient currents associated with motors and pumps.



Warning: 120VAC wiring should be installed by a qualified electrician.

6.2.12 POWER INPUT WIRING

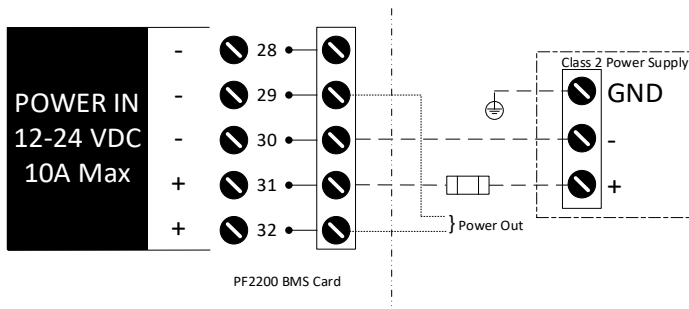

Installation Notes:

1. The PF2200 must be powered from a Class 2 power supply as defined in the Canadian Electrical Code (CSA 22.2 No 1-15) or US National Electrical Code (NFPA 70).

6.2.13 ANALOG OUTPUT – 4-20mA ECHO TO PLC

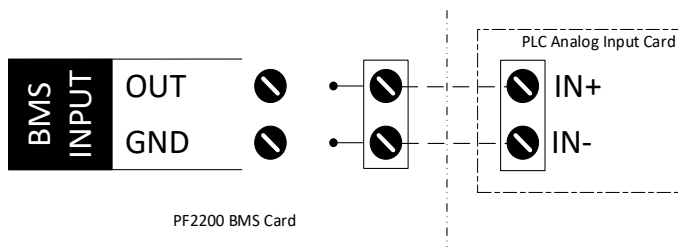

Installation Notes:

1. 4-20mA Input IN- terminal must be run back to BMS Input GND terminal (Local ground) to ensure proper output functionality.

6.2.14 SINGLE ROD IGNITION WIRING

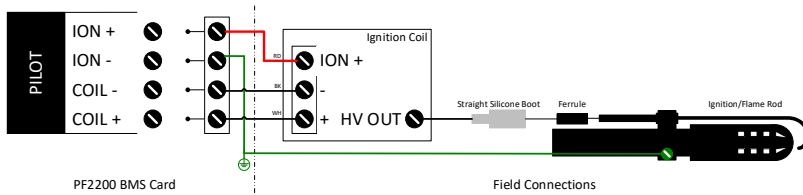

Installation Notes:

1. The wire length between the ignition coil and pilot should be no more than 5m (15ft).
2. For long run lengths connect burner housing to ION - terminal with ignition cable to avoid ground-loading



Warning: Failure to provide a low-impedance path from the burner assembly to the PF2200 may result in electric shock, product damage, failure to ignite the pilot, or failure to detect flame.

6.2.15 DUAL ROD IGNITION WIRING

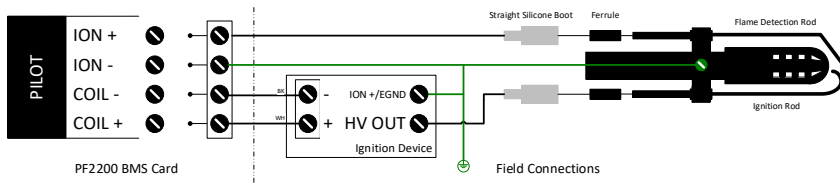

Installation Notes:

1. The wire length between the ignition coil and pilot should be no more than 5m (15ft).
2. For long run lengths connect burner housing to ION - terminal with ignition cable to avoid ground-loading



Warning: Failure to provide a low-impedance path from the burner assembly to the PF2200 may result in electric shock, product damage, failure to ignite the pilot, or failure to detect flame.

6.2.16 TEMPERATURE INPUT- DUAL TYPE K THERMOCOUPLE

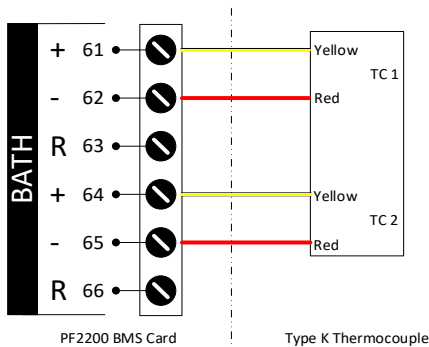

Installation Notes:

1. Thermocouple must be grounded or ungrounded Type K.
2. Thermocouple wire run lengths should be minimized where possible.
3. Thermocouple wires should not be run in the same conduit as high-noise signals (e.g. valve wires, motor wires, etc.)

6.2.17 TEMPERATURE INPUT- DUAL 3-WIRE RTD

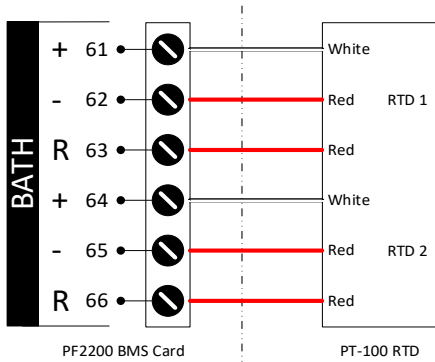

6.2.18 TEMPERATURE INPUT- SINGLE TYPE K THERMOCOUPLE

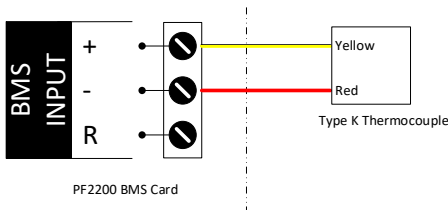

Installation Notes:

1. Thermocouple must be grounded or ungrounded Type K.
2. Thermocouple wire run lengths should be minimized where possible.
3. Thermocouple wires should not be run in the same conduit as high-noise signals (e.g. valve wires, motor wires, etc.)

6.2.19 TEMPERATURE INPUT- SINGLE 3-WIRE RTD

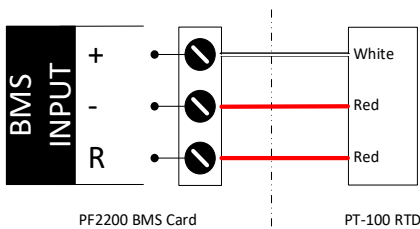

6.2.20 MODBUS INPUT WIRING

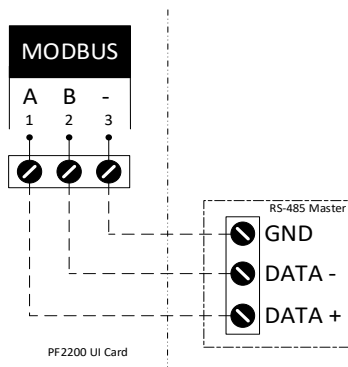

Installation Notes:

1. Modbus wires should not be run in the same conduit as high-noise signals (e.g. valve wires, motor wires, etc.)

6.2.21 UV FLAME SCANNER WIRING

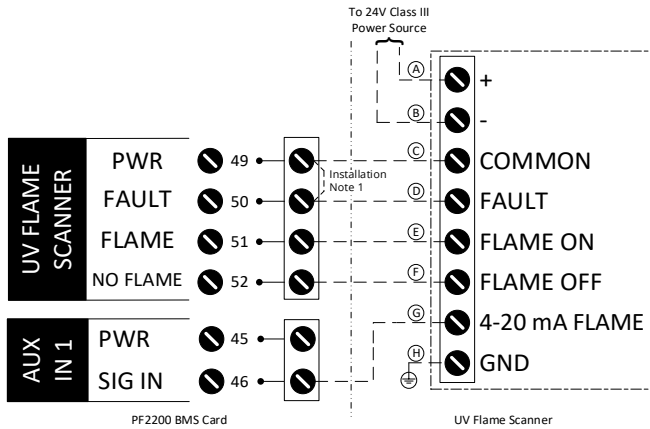

Wire Colors for approved UV Flame Scanners:

Wire	Fireye 65UV5-1004E	Zeeco ZPF-120
A	Brown	Red
B	White	Blue
C	Blue	Brown
D	Black	N/A
E	Yellow	Green
F	Red	White
G	Orange	Pink
H	Green	Grey

Installation Notes:

1. When using Zeeco ZPF-120 flame scanner, a wire jumper must be installed between BMS terminals 49 and 50, as the scanner does not have a separate fault output.

7 SYSTEM CONFIGURATION

The following section describes each configuration setting found in the menus of the PF2200-SB. All settings changes must be verified prior to starting the system and functional tests must be performed to ensure that all expected alerts ring in correctly. The best way to verify the system configuration is to manually force an alarm condition on each connected input or output device independently and verify that the PF2200 annunciates the appropriate alarm.



Warning: System settings must only be modified by qualified personnel who have an understanding of the appliance under control and its effect on the other plant processes.

7.1 TEMPERATURES

7.1.1 BATH INPUT

Name	Default	Options / Range	Description
Type	RTD	TC RTD	Temperature sensing element type. Type K Thermocouple (grounded or ungrounded) or PT100 RTD.
Input	Dual	Dual Single	Configuration control for the Bath input. Dual requires two unique temperature sensing elements, whereas single only requires one.
Input setting is required to be set to Dual if the Bath Input is specified as a safety function.			
Mode	Process Control	Process Control High Temp ESD	Mode for the temperature input, used by the system to determine how the input is to be used.
At least one of Bath Mode, Outlet Mode, or Aux Temp Mode must be set to Process Control			
High Temp Setpoint	90 °C 194 °F	0 °C - 1350 °C 32 °F - 2462 °F	Temperature threshold at which the system shuts down.
High Temp Setpoint must be greater than Pilot Off Setpoint and If Type setting is set to RTD, High Temp Setpoint must be less than 850 °C (1562 °F)			
Pilot Off Setpoint	85 °C 185 °F	0 °C - 1350 °C 32 °F - 2462 °F	Temperature threshold at which the system turns off the pilot valve(s).
Pilot Off Setpoint must be greater than Main Off Setpoint and less than High Temp Setpoint			
Main Off Setpoint	85 °C 185 °F	0 °C - 1350 °C 32 °F - 2462 °F	Temperature threshold at which the system turns off the main valve(s).
Main Off Setpoint must be greater than Process Setpoint and less than Pilot Off Setpoint			
Process Setpoint	80 °C 176 °F	0 °C - 1350 °C 32 °F - 2462 °F	Temperature that the system attempts to maintain when in Process Control mode.
Process Setpoint must be greater than Low Temp Setpoint and less than Main Off Setpoint			
Standby Setpoint	70 °C 158 °F	0 °C - 1350 °C 32 °F - 2462 °F	Minimum bath temperature the system will try to maintain in Bath Standby Mode.
Settings > Process Control > Configuration > Bath Standby Mode must be enabled Settings > Process Control > Configuration > Process Control Mode must be set to On/Off Control Standby Setpoint must be at least 2 degrees lower than the Process Setpoint			
Low Temp Setpoint	0 °C 32 °F	0 °C - 1350 °C 32 °F - 2462 °F	Temperature threshold at which, if not exceeded, the system warns the user.
Low Temp Setpoint must be less than Process Setpoint			
Deadband	2 °C 3.6 °F	0 °C - 100 °C 0 °F - 180 °F	The deadband prevents bouncing between states when the input reading is close to the corresponding setpoint.

7.1.2 OUTLET INPUT

Name	Default	Options / Range	Description
Type	RTD	TC RTD	Temperature sensing element type. Can be Type K Thermocouple (grounded or ungrounded) or PT100 RTD.
Mode	Disabled	Disabled Process Control High Temp ESD Display Only	Mode for the temperature input, used by the system to determine how the input is to be used. See Temperature Inputs section for more details.
At least one of Bath Mode, Outlet Mode, or Aux Temp Mode must be set to Process Control			
High Temp Setpoint	90 °C 194 °F	0 °C - 1350 °C 32 °F - 2462 °F	Temperature threshold at which, if exceeded, the system will shut down.
Only applicable if the mode is set to High Temp ESD or Process Control. High Temp must be greater than Pilot Off Setpoint AND If Type is RTD, must be less than 850 °C (1562 °F)			
Pilot Off Setpoint	85 °C 185 °F	0 °C - 1350 °C 32 °F - 2462 °F	Temperature threshold at which the system will turn off the pilot valve(s).
Pilot Off Setpoint must be greater than Main Off Setpoint and less than High Temp Setpoint			
Main Off Setpoint	85 °C 185 °F	0 °C - 1350 °C 32 °F - 2462 °F	Temperature threshold at which the system will turn off the main valve(s).
Main Off Setpoint must be greater than Process Setpoint and less than Pilot Off Setpoint			
Process Setpoint	80 °C 176 °F	0 °C - 1350 °C 32 °F - 2462 °F	Temperature that the system attempts to maintain when in Process Control mode.
Process Setpoint must be greater than Low Temp Setpoint and less than Main Off Setpoint			
Low Temp Setpoint	0 °C 32 °F	0 °C - 1350 °C 32 °F - 2462 °F	Temperature threshold at which, if not exceeded, the system will warn the user.
Low Temp Setpoint must be less than Process Setpoint			
Deadband	2 °C 3.6 °F	0 °C - 100 °C 0 °F - 180 °F	The deadband prevents bouncing between states when the input reading is close to the corresponding setpoint.

7.1.3 STACK INPUT

Name	Default	Options / Range	Description
Type	RTD	TC RTD	Temperature sensing element type. Can be Type K Thermocouple (grounded or ungrounded) or PT100 RTD.
Mode	Disabled	Disabled High Temp ESD Display Only	Mode for the temperature input, used by the system to determine how the input is to be used.
High Temp Setpoint	90 °C 194 °F	0 °C - 1350 °C 32 °F - 2462 °F	Temperature threshold at which the system will shut down.
Only applicable if the mode is set to High Temp ESD If Type is RTD, High Temp Setpoint must be less than 850 °C (1562°F)			
Deadband	2 °C 3.6 °F	0 °C - 100 °C 0 °F - 180 °F	The deadband prevents bouncing between states when the input reading is close to the corresponding setpoint.

7.1.4 AUX TEMP INPUT

Name	Default	Options / Range	Description
Mode	Disabled	Disabled Process Control High Temp ESD Display Only	Mode for the temperature input, used by the system to determine how the input is to be used. See Temperature Inputs section for more details.
At least one of Bath Mode, Outlet Mode, or Aux Temp Mode must be set to Process Control			
High Temp Setpoint	90 °C 194 °F	0 °C - 1350 °C 32 °F - 2462 °F	Temperature threshold at which, if exceeded, the system will shut down.
Only applicable if the mode is set to High Temp ESD or Process Control. High Temp Setpoint must be greater than Pilot Off Setpoint and In RTD mode must be less than 850 °C			
Pilot Off Setpoint	85 °C 185 °F	0 °C - 1350 °C 32 °F - 2462 °F	Temperature threshold at which, if exceeded, the system will turn off the pilot valve(s).
Pilot Off Setpoint must be greater than Main Off Setpoint and less than High Temp Setpoint			
Main Off Setpoint	85 °C 185 °F	0 °C - 1350 °C 32 °F - 2462 °F	Temperature threshold at which, if exceeded, the system will turn off the main valve(s).
Main Off Setpoint must be greater than Process Setpoint and less than Pilot Off Setpoint			
Process Setpoint	80 °C 176 °F	0 °C - 1350 °C 32 °F - 2462 °F	Temperature setpoint the system attempts to maintain when in Process Control mode.
Process Setpoint must be greater than Low Temp Setpoint and less than Main Off Setpoint			
Low Temp Setpoint	0 °C 32 °F	0 °C - 1350 °C 32 °F - 2462 °F	Temperature threshold at which, if not exceeded, the system will warn the user.
Low Temp Setpoint must be less than Process Setpoint and greater than Span Min			
Deadband	2 °C 3.6 °F	0 °C - 100 °C 0 °F - 180 °F	The deadband prevents the system from bouncing between states when the input reading is close to the corresponding setpoint. See Temperature Inputs section for more details.
4-20 Span Min	0 °C 32 °F	-100 °C - 1350 °C -148 °F - 2462 °F	Temperature value corresponding to 4mA output from the 4-20mA transmitter.
Span Min must be less than Span Max and Low Temp Setpoint			
4-20 Span Max	1350 °C 2462 °F	-100 °C - 1350 °C -148 °F - 2462 °F	Temperature value corresponding to 20mA output from the 4-20mA transmitter.
Span Max must be greater than Span Min and High Temp Setpoint			

7.2 INPUTS

7.2.1 LEVEL/FLOW INPUT

Name	Default	Options / Range	Description
Type	Digital	Disabled Digital 4-20	Level/Flow sensor type. Can be configured as a switch (digital), transmitter (4-20), or disabled.
Digital Mode	Alarm	Alarm Wait Warning	Action the system will take when a de-energized contact occurs.
Type must be set to Digital			
4-20 Low Trip Mode	Alarm	Alarm Wait Warning	Action the system will take when a low-trip event occurs.
Type must be set to 4-20			
4-20 High Trip Mode	Alarm	Alarm Wait Warning	Action the system will take when a high-trip event occurs.
Type must be set to 4-20			
4-20 Low Trip Setpoint	60 L 15.9 gal	Span Min to Max	Input threshold at which the system will initiate a low-trip event in accordance with the 4-20 Low Trip Mode setting.
Type must be set to 4-20			
4-20 High Trip Setpoint	117 L 30.9 gal	Span Min to Max	Input threshold at which the system will initiate a high-trip event in accordance with the 4-20 High Trip Mode setting.
Type must be set to 4-20			
4-20 Deadband	1.5 L 0.4 gal	0 - 6.25% of Span	The deadband prevents bouncing between states when the input reading is close to the corresponding trip point.
To clear a low trip, input must be greater than 4-20 Low Trip plus deadband.			
To clear a high trip, input must be less than 4-20 High Trip minus deadband.			
4-20 Span Min	0 L 0 gal	0 - 10000000 L 0 - 2641720 gal	Level/Flow value corresponding to 4mA output from the 4-20mA transmitter.
Span Min must be less than Span Max and 4-20 Low Trip			
4-20 Span Max	120 L 31.7 gal	0 - 10000000 L 0 - 2641720 gal	Level/Flow value corresponding to 20mA output from the 4-20mA transmitter.
Span Max must be greater than Span Min and 4-20 High Trip			
Level/Flow Delay	2 sec	2 sec - 20 sec	The amount of time the system requires a low-input event be consistent for before performing the low-trip action.

7.2.2 PRESSURE INPUT

Name	Default	Options / Range	Description
Type	Digital	Disabled Digital 4-20	Pressure sensor type. Can be configured as a switch (digital), transmitter (4-20), or disabled.
4-20 Low Trip	0 kPa 0 psi	Span Min to Max	Input threshold at which the system will initiate a low-trip event in accordance with the Low Pressure Mode setting.
Type must be set to 4-20			
4-20 High Trip	177 kPa 25.7 psi	Span Min to Max	Pressure threshold that, if exceeded, the system will shutdown.
Type must be set to 4-20			
4-20 Deadband	2.6 kPa 0.4 psi	0 – 6.25% of span	The deadband prevents bouncing between states when the input reading is close to the corresponding trip point.
To clear a low trip, input must be greater than 4-20 Low Trip plus deadband.			
To clear a high trip, input must be less than 4-20 High Trip minus deadband.			
4-20 Span Min	0 kPa 0 psi	0 - 100000 kPa 0 psi - 14504 psi	Pressure value corresponding to 4mA output from the 4-20mA transmitter.
Span Min must be less than Span Max and 4-20 Low Trip			
4-20 Span Max	207 kPa 30 psi	0 - 100000 kPa 0 psi - 14504 psi	Pressure value corresponding to 20mA output from the 4-20mA transmitter.
Span Max must be greater than Span Min and 4-20 High Trip			
Low Pressure Mode	Alarm	Alarm Wait Warning Main Permissive	Action the system will take when a low-pressure event occurs.
Low Pressure Delay	2 sec	2 sec - 20 sec	The amount of time a low-pressure condition must be present before the system takes any action.

7.2.3 PRESSURE HIGH INPUT

Name	Default	Options / Range	Description
Pressure High	Enabled	Disabled Enabled	See High Pressure Input section for more details.

7.2.4 PROOF OF CLOSURE INPUT

Name	Default	Options / Range	Description
Proof of Closure	Enabled	Disabled Enabled	Controls whether the Proof of Closure input is enabled or disabled. See Proof of Closure Input section for details.

7.2.5 REMOTE START INPUT

Name	Default	Options / Range	Description
Remote Start	Disabled	Disabled Enabled	Controls whether the Remote Start input is enabled or disabled. See Remote Start Input section for more details.

7.2.6 PROOF OF LIGHT OFF POSITION INPUT

Name	Default	Options / Range	Description
Type	Disabled	Disabled Digital 4-20	Light Off Position sensor type. Can be configured as a switch (digital), transmitter (4-20), or disabled.
Setpoint	50%	0 – 100%	Point at which the sensor is in the Light Off position.
Tolerance	1.50%	0 – 6.2%	Allowable position error tolerance of the Light Off Position Input device.

7.2.7 AUX IN 1 & AUX IN 2 INPUTS

Name	Default	Options / Range	Description
Type	Digital	Disabled Digital 4-20	Input sensor type. Can be configured as a switch (digital), transmitter (4-20), or disabled.
4-20 Mode	High/Low Trip	High/Low Trip Appliance Firing Rate Bath Process SP Adjust Outlet Process SP Adjust Aux Temp Process SP Adjust UV Flame Quality	Various modes for the Aux input when configured as a 4-20 type. See Auxiliary Inputs section for more details.
Type must be set to 4-20			
Digital Mode	Alarm	Alarm Wait Warning Main Permissive	Action the system will take when a de-energized contact occurs.
Type must be set to Digital			
4-20 Low Trip Mode	Alarm	Alarm Wait Warning Main Permissive	Action the system will take when a low-trip event occurs.
Type must be set to 4-20			
4-20 High Trip Mode	Alarm	Alarm Wait Warning Main Permissive	Action the system will take when a high-trip event occurs.
Type must be set to 4-20			
4-20 Low Trip	0%	0 - 100%	Input threshold at which the system will initiate a low-trip event in accordance with the 4-20 Low Trip Mode setting.
Type must be set to 4-20			
4-20 High Trip	100%	0 - 100%	Input threshold at which the system will initiate a high-trip event in accordance with the 4-20 High Trip Mode setting.
Type must be set to 4-20			
4-20 Deadband	1.20%	0 - 100%	The deadband prevents the system from bouncing between states when the input reading is close to the corresponding trip point.
Type must be set to 4-20			
To clear a low trip, input must be greater than 4-20 Low Trip plus deadband.			
To clear a high trip, input must be less than 4-20 High Trip minus deadband.			
4-20 Span Min	0%	0% - 100%	Input value corresponding to 4mA output from the 4-20mA transmitter.
Type must be set to 4-20			
Span Max must be greater than Span Min			
4-20 Span Max	100%	0% - 100%	Input value corresponding to 20mA output from the 4-20mA transmitter.
Type must be set to 4-20			
Span Max must be greater than Span Min			

7.3 PROCESS CONTROL

7.3.1 CONFIGURATION

Name	Default	Options / Range	Description
Process Control Mode	On/Off Control	On/Off Control Staged Heating Bath PID Control Outlet PID Control Aux PID Control Cascaded PID Control External Firing Rate	Control mode of the system. Refer to Process Control section for more details.
Pilot Off Mode	Disabled	Disabled Off at Pilot Off Setpoint Off at Main Off Setpoint Interrupted	Defines when the system turns off the Pilot valve while running:
When set to Interrupted – UV Flame Detect must be set to Main Only OR Pilot and Main			
Pilot 2	Disabled	Disabled Enabled	Enables the second Pilot valve output and flame detection input.
When Enabled – UV Flame Detect Mode must be set to Disabled OR Main Only			
Minimum Pilots Running	1	1 - 2	Specifies the number of pilots that must be lit for the system to remain running.
When set to 2 – Pilot 2 must be enabled			
Reignition	Disabled	Disabled Enabled	Specifies whether the system will automatically attempt to reignite a lost pilot flame.
Pilot 2 must be enabled Minimum Pilots Running must be set to 1			
UV Flame Detect Mode	Disabled	Disabled Main Only Pilot and Main	Specifies where UV flame detection will be used.
Bath Standby Mode	Disabled	Disabled Enabled	Specifies whether Bath Standby Mode will be used.
Process Control Mode must be set to On/Off Control Inputs > Temperatures > Bath > Mode must be set to Process Control One of Inputs > Temperatures > Outlet OR Aux Temp > Mode must be set to Process Control			

7.3.2 TIMING

Name	Default	Options / Range	Description
Purge Time	60 sec	10 sec – 900 sec	Time which the system will remain in the Purge state.
Pilot Startup Delay Time	15 sec	15 sec – 600 sec	Minimum time which the system will remain in the Pilot state when starting.
Request Light Off Delay Time	5 sec	5 sec – 900 sec	Time that the system will wait for TCV to reach its Light Off Position before energizing the main valves.
Main Startup Delay Time	30 sec	30 sec – 600 sec	Minimum time which the system will remain in a minimum firing state when prior to entering the Process Control state.

7.3.3 IGNITION

Name	Default	Options / Range	Description
Ignition Mode	Coil	Coil HEI	Controls the Coil output behavior when in the ignition state: Coil: Pulsed output mode HEI: constant output mode
Relight Attempts	3	0 - 3 attempts	Determines the number of relight attempts the system will use when establishing flame.

7.3.4 PID CONTROL

Name	Default	Options / Range	Description
Process Proportional Band	10 °C 18 °F	0 °C - 1000 °C 0 °F - 1800 °F	This is the proportional Band used for the PID calculation. In cascaded control mode this value applies to the bath PID loop.
Process Integral Time	4 mins/rep	0 - 1000 mins/rep	This is the integral time used for the PID calculation.
Process Derivative Time	0 min	0 min - 1000 min	This is the derivative time used for the PID calculation.
Process Integral Reset Range	10 °C 18 °F	0 °C - 1000 °C 0 °F - 1800 °F	Process temperature range in which the integral term will accumulate.
Cascade Proportional Band	10 °C 18 °F	0 °C - 1000 °C 0 °F - 1800 °F	Proportional Band setting for cascaded PID. Inputs > Process Control > Configuration > Process Control Mode must be set to Cascaded PID Control
Cascade Integral Time	0 mins/rep	0 mins/rep - 1000 mins/rep	Integral time setting for cascaded PID. Inputs > Process Control > Configuration > Process Control Mode must be set to Cascaded PID Control
Cascade Derivative Time	0 min	0 min - 1000 min	Derivative time setting for cascaded PID. Inputs > Process Control > Configuration > Process Control Mode must be set to Cascaded PID Control
Cascade Integral Reset Range	10 °C 18 °F	0 °C - 1000 °C 0 °F - 1800 °F	In cascaded mode this is the boundary of the integral windup range for the outlet temperature. If the outlet temperature is outside of this range the integral term will not accumulate.
Output Rate Limit	100 %/sec	0.1 - 100 %/sec	This is the limit for the maximum output change of the TCV per second. A larger value allows for a quicker change in output. A smaller value slows down any change in output. This can help prevent fast movements from the TCV.
Ramp Time	10 sec	0 sec - 255 sec	Once the system enters process control mode after light off delay it will slowly ramp to the requested firing rate over this time.

7.4 OUTPUTS

7.4.1 STATUS OUTPUT

Name	Default	Options / Range	Description
Status Contact Mode	Run Status	Run Status Heating Status Low Temp Warning Level/Flow Control	Defines the behavior of the Status Contact. See Status Relay Output section for more details.
Level/Flow Control Setpoint	18 mA	4mA – 20mA	Defines the Level/Flow setpoint at which the Status Contact changes state.

Status Contact Mode must be set to Level/Flow Control

7.4.2 VALVE OUTPUTS

Name	Default	Options / Range	Description
Pilot Valve PWM	60%	1 % - 100 %	Duty cycle of the output. Higher value corresponds to higher average output.
SSV PWM	60%	1 % - 100 %	Duty cycle of the output. Higher value corresponds to higher average output.
High Fire Valve PWM	60%	1 % - 100 %	Duty cycle of the output. Higher value corresponds to higher average output.

7.4.3 AUX OUT 1 & AUX OUT 2 OUTPUTS

Name	Default	Options / Range	Description
Mode	Disabled	Disabled Level/Flow Echo Aux In 1 Echo Aux In 2 Echo Modbus Echo Bath Temp Echo Outlet Temp Echo Stack Temp Echo Aux Temp Echo	Defines the behavior of the Auxiliary Output. See Auxiliary Outputs section for more details.
Temp Echo Span Min	0 °C 32 °F	-100 °C - 1350 °C -148 °F - 2462 °F	Temperature value corresponding to 4mA from the Auxiliary Output.
Span Max must be greater than Span Min			
Temp Echo Span Max	1350 °C 2462 °F	-100 °C - 1350 °C -148 °F - 2462 °F	Temperature value corresponding to 20mA from the Auxiliary Output.
Span Max must be greater than Span Min			

7.4.4 TCV OUTPUT

Name	Default	Options / Range	Description
Manual Override	Disabled	Disabled Enabled	Manual override TCV functionality, used in conjunction with Manual Position setting.
Manual Position	0%	0 % - 100 %	Position of TCV when Manual Override is enabled.
Min Position	40%	0 % - 70 %	Minimum position for the TCV output.
Purge Position	100%	0 % - 100 %	Position for the TCV output during the Purge state.
Pilot Position	40%	0 % - 100 %	Position for the TCV output during the Ignition and Pilot states.

7.5 SETUP

7.5.1 COMMISSIONING

Name	Default	Options / Range	Description
Voltage Setting	12V	12V 24V	Sets the expected input voltage for the system.
Voltage Restart	Disabled	Disabled Enabled	Allows the system to automatically restart after a low voltage event while running.
L1 Password Enable	Disabled	Disabled Enabled	Enabling this mode allows L1 password control on some non-safety critical settings.
Comm Loss Alarm	Disabled	Disabled Enabled	Specifies whether the system will shut down when the BMS and UI lose communication with one another.
Commissioning Complete	Incomplete	Incomplete Complete	Setting to confirm all commissioning checks have been performed.
Current Date/Time	Jan 1 2000 12:00 AM		Sets the date and time for accurate event and data logging.

7.5.2 MODBUS

Name	Default	Options / Range	Description
Modbus RTU Communication	Disabled	Disabled Enabled	Enables or disables Modbus communication.
Modbus Termination	Disabled	Disabled Enabled	Enables or disables Modbus termination resistor.
Baud Rate	9600	9600 19200	Baud rate for the RS-485 link.
Stop Bits	1	1 2	Number of stop bits. Used for configuring the RS-485 protocol.
Parity	None	None Odd Even	Parity bit support. Used for configuring the RS-485 protocol.
Slave Address	1	1 - 247	Modbus slave address of the PF2200.

7.5.3 UNITS

Name	Default	Options / Range	Description
Temperatures	Celsius	Celsius Fahrenheit	Display units for Temperature inputs.
Pressure	kPa	kPa psi inch wc oz/in ² kg/cm ² Percent Milliamps	Display units for Pressure input.
Level	Litres	Litres m ³ US Gallons bbl ft ³ Percent Milliamps	Display units for Level/Flow input when configured as a Level input
Flow	L/sec	L/sec L/min m ³ /sec m ³ /min US Gal/sec US Gal/min bbl/sec bbl/min ft ³ /sec ft ³ /min Percent Milliamps	Display units for Level/Flow input when configured as a Flow input
Level/Flow Input Units	Level	Level Flow	Sets whether Level/Flow Input is used as a Level input or a Flow input
Aux In 1	Percent	Percent Milliamps Temperature Pressure Level/Flow	Display units for Aux In 1
Aux In 2	Percent	Percent Milliamps Temperature Pressure Level/Flow	Display units for Aux In 2

8 MAINTENANCE



Warning: Do not modify any system wiring or handle the electronics while the system is powered.



Caution: Do not disassemble or modify the cards in any way. The cards are not field repairable and must be sent back to Profire for replacement if damaged.



Caution: The enclosure door must be securely closed after opening. Improper closure may result in moisture or other environmental damage and may compromise the integrity of the product.

8.1 RECOMMENDED MAINTENANCE PROCEDURES

A comprehensive plan for routine maintenance should be developed in accordance with local safety codes, application requirements and manufacturer recommendations for all equipment used. The maintenance plan should include, but not be limited to the following recommended maintenance procedures:

1. Check all wiring against site wiring diagram.
2. Check enclosures, boards and fittings for signs of wear and replace as needed.
3. Check for moisture in enclosures and replace or recharge desiccant as needed.
4. Verify functionality of all keypad buttons.
5. Verify UI screen display functionality.
6. Verify accuracy of all settings.
7. Verify card hardware and firmware versions are up to date and compatible.
8. Verify all instrumentation and fuel train components are functional and undamaged.
9. Verify all heater components are functional and undamaged.
10. Verify that all configured interlock trips result in appropriate alert annunciation.
11. Verify calibration of all 4-20 mA input devices and temperature input devices

It is expected that the PF2200 temperature and analog inputs are within the stated accuracy range for the lifetime of the product. Calibration and verification frequency is to be determined in accordance with the manufacturer recommendations for the connected end devices and the applicable local safety codes.

8.2 TRANSPORTATION AND STORAGE CONDITIONS

Transportation of the product shall be in the original product packaging or equivalent. Transportation of cards without enclosure is not recommended and should be done with the utmost care utilizing an Anti-Static/ESD bag.

Storage temperature should be kept within the operating temperature listed in Section 3 in a dry area. Avoid moisture buildup inside the enclosure.

8.3 REPAIR AND REPLACEMENT

Profire does not support on-site repairs for cards. For replacement cards contact Profire customer service.

In the event replacement card(s) are used, care must be taken to ensure proper firmware is loaded on both the User Interface and BMS cards. If the User Interface and BMS cards have different software bundles loaded on them, the system will fail to operate correctly and will require a firmware update to match.

BMS cards must be securely fastened into the back of the enclosure with six #10-32 machine screws.

UI cards must not be removed from the enclosure door. Should a UI card replacement be required, an entire door assembly will be shipped.

8.4 DECOMMISSIONING

When decommissioning the system, the appliance should be safely shut down (i.e. all safety outputs are turned off and there are no gas leaks on site). Once the appliance is in a safe state, the power should be disconnected from the PF2200. All cards should be treated like any other piece of electronics (e.g. be sent to a recycling depot).

8.5 USEFUL LIFE

The useful life of the PF2200 is 10 years. Prior to the expiry of that period the customer should contact Profire for a suitable replacement.

8.6 MANUFACTURER NOTIFICATION

Any detected failures that compromise the functional safety of the system must be reported to Profire customer service immediately.

9 TROUBLESHOOTING

Problem	Proposed Solutions
System has visible flame but cannot detect	<ol style="list-style-type: none"> 1. Ensure pilot assembly, flame rod, and the gap between are fully engulfed in flame. If not, adjust rod position 2. Ensure flame detection wiring does not exceed the recommended maximum length 3. Ensure burner assembly has a low impedance path to Ion- terminal of BMS 4. For longer run lengths, ensure ignition cable is used to avoid ground-loading
Card is unresponsive or BMS card will not communicate with User Interface card	<ol style="list-style-type: none"> 1. Ensure the Status LEDs for both cards are functioning. If status LED is not functioning, cycle power (if safe to do so) and check again. 2. Check the wiring between the BMS card and the User Interface Card.
Ignition transformer "clicks" but no visible spark	<ol style="list-style-type: none"> 1. Ensure all wires in the ignition path are properly terminated and that there is a low impedance path from the primary-windings to the BMS card as well as the secondary-windings to the ignition rod. 2. Ensure the gap between the ignition rod and the burner housing is within the tolerances specified in the Product Declarations section under "High Voltage Spark Gap Range".
Solenoids are not turning on, or turning on then over time turn off	<ol style="list-style-type: none"> 1. Ensure the solenoid is wired correctly and to the appropriate terminals. To ensure proper solenoid wiring, a multi-meter in OHM mode can be used to measure the resistance between the + and - terminal of the associated output. Note: this measurement should be done with the BMS card powered off. If properly wired, the multi-meter should read a resistance of the solenoid coil plus the run length (i.e. if the multimeter reads open, there is likely a problem with wiring). 2. Ensure the PWM setting is correct for the appropriate solenoid. If using a peak-and-hold solenoid, the appropriate PWM setting can be found in the solenoid data sheet. Typically add a margin of 5-10% to allow for temperature variance. If using a non-peak-and-hold solenoid, ensure the PWM setting is set to 100%.
Digital input will not energize	<ol style="list-style-type: none"> 1. Ensure the input is properly wired. See Connection Diagrams section. In the case of a dry contact, ensure the PWR terminal is connected and is sourcing the correct voltage. 2. Ensure adequate amount of wetting current is being applied to through contact. Run a current meter in series with the digital input switch and verify the energized state meets the requirements outlined in the BMS Card Electrical Ratings section. If the wetting current is not adequate, the digital input either has too high of an impedance or the wiring has been compromised.

10 ALERT CODES & RESPONSE TIMES

10.1 ALARMS

ID	Name	Alarm Condition	Set
AL001	Proof of Closure Contact Open	POC input is open while SSV outputs de-energized	2s
AL002	ESD Contact Open	ESD input is open	1s
AL003	Pressure Out of Range	Pressure Input in 4-20 mode: Input is less than 3 mA OR greater than 21 mA Pressure Input in Digital mode: Input is not within valid range ^[1]	1s
AL004	Low Pressure	Pressure Input in 4-20 mode: Input is less than Pressure Low Trip setting Pressure Input in Digital mode: Input is open	Low Pressure Delay setting
AL005	High Pressure 4-20	Pressure Input in 4-20 mode: Input is greater than High Trip setpoint AND SSV outputs energized Pressure Input in Digital mode: This alarm cannot be set	2s
AL006	High Pressure Out of Range	High Pressure input is not within valid range ^[1]	1s
AL007	High Pressure Contact	High Pressure input is open	2s
AL008	Pressure Configuration Error	Pressure High Trip setting is less than Pressure Low Trip plus Pressure Deadband OR Pressure Span Max is less than Pressure Span Min	0
AL009	Proof of Light Off Out of Range	Proof of Light Off Input In 4-20 mode: Input is less than 3 mA OR greater than 21 mA Pressure Input in Digital mode: Input is not within a valid range ^[1]	1s
AL010	Failed to Prove Light Off Position	Light off position not proven during the <i>Main Light Off</i> state	0
AL011	Level/Flow Out of Range	Level Input in 4-20 mode: Input is less than 3 mA OR greater than 21 mA Level Input in Digital mode: Input is not within a valid range ^[1]	1s
AL012	Low Level/Flow	Level Input in 4-20 mode: Input is less than Level Low Trip setting Level Input in Digital mode: Input is open	Level/Flow Delay setting
AL013	High Level/Flow	Level input in 4-20 mode: Input is greater than Level High Trip Level input in Digital mode: This alarm cannot be set	Level/Flow Delay setting
AL014	Level/Flow Configuration Error	Level High Trip setting is less than Level Low Trip plus Level Deadband OR Level Span Max less than Level Span Min	0
AL015	Aux In 1 Contact Open	Aux In 1 input in 4-20 mode: This alarm cannot be set Aux In 1 input in Digital mode: Input is open	2s
AL016	Aux In 1 Out of Range	Aux In 1 Input in 4-20 mode: Input is less than 3 mA OR greater than 21 mA Aux In 1 Input in Digital mode: Input is not within a valid range ^[1]	1s
AL017	Aux In 1 Low Trip	Aux In 1 Input in 4-20 mode: Input is less than Aux In 1 Low Trip setting Aux In 1 Input in Digital mode: This alarm cannot be set	2s
AL018	Aux In 1 High Trip	Aux In 1 Input in 4-20 mode: Input is greater than Aux In 1 High Trip setting Aux In 1 Input in Digital mode: This alarm cannot be set	2s
AL019	Aux In 1 Configuration Error	Input High Trip less than Input Low Trip plus Input Deadband OR Input Span Max less than Input Span Min OR Input High Trip greater than Input Span Max OR Input Low Trip less than Input Span Min OR Mode is Appliance Firing Rate AND Process Control Mode is not External Firing Rate OR Both Aux In 1 and Aux in 2 are set up as Appliance Firing Rate inputs OR Both Aux In 1 and Aux in 2 are set up as Process Setpoint Adjust inputs OR Both Aux In 1 and Aux in 2 are set up as UV Flame Quality inputs	0
AL020	Aux In 2 Contact Open	Aux In 2 input in 4-20 mode: This alarm cannot be set Aux In 2 input in Digital mode: Input is open	2s
AL021	Aux In 2 Out of Range	Aux In 2 Input in 4-20 mode: Input is less than 3 mA OR greater than 21 mA Aux In 2 Input in Digital mode: Input is not within a valid range ^[1]	1s
AL022	Aux In 2 Low Trip	Aux In 2 Input in 4-20 mode: Input is less than Aux In 2 Low Trip setting Aux In 2 Input in Digital mode: This alarm cannot be set	2s
AL023	Aux In 2 High Trip	Aux In 2 Input in 4-20 mode: Input is greater than Aux In 2 High Trip setting Aux In 2 Input in Digital mode: This alarm cannot be set	2s
AL024	Aux In 2 Configuration Error	Input High Trip less than Input Low Trip plus Input Deadband OR Input Span Max less than Input Span Min OR Input High Trip greater than Input Span Max OR Input Low Trip less than Input Span Min OR Mode is Appliance Firing Rate AND Process Control Mode is not External Firing Rate OR Both Aux in 1 and Aux in 2 are set up as Appliance Firing Rate inputs OR Both Aux in 1 and Aux in 2 are set up as Process Setpoint Adjust inputs OR Both Aux in 1 and Aux in 2 are set up as UV Flame Quality inputs	0
AL025	Process Setpoint Adjust Lacks Process Temp	Process Setpoint Adjust input is configured to use a temperature that is not set up for Process Control	0

ID	Name	Alarm Condition	Set
AL026	Bath High Temp ESD	Bath Temperature Input is greater than High Temp ESD setpoint	2s
AL027	Bath Temp Mismatch	Bath Temperature Input 1 does not match Bath Temperature Input 2	2s
AL028	Bath Temp Configuration Range Error	Bath High Temp Setpoint is out of range OR Pilot Off Setpoint (if enabled) is greater than or equal to the High Temp Setpoint OR Main Off Setpoint (if enabled) is greater than or equal to the High Temp Setpoint OR Main Off Setpoint (if enabled) is greater than the Pilot Off Setpoint (if enabled) OR Process Setpoint is greater than or equal to the High Temp Setpoint OR Process Setpoint is greater than the Pilot Off Setpoint (if enabled) OR Process Setpoint is greater than the Main Off Setpoint (if enabled) OR Low Temp Setpoint is greater than the Process Setpoint	0
AL029	Bath 1 Sensor Open	Bath Input 1 sensor has an open circuit	6s
AL030	Bath 1 Sensor Short	Bath Input 1 in RTD Mode: Input is measuring a short circuit Bath Input 1 in Thermocouple Mode: This alarm cannot be set	6s
AL031	Bath 1 Out of Range	Bath Input 1 in RTD Mode: Input is outside valid RTD range Bath Input 1 in Thermocouple Mode: Input is outside valid Thermocouple range	6s
AL032	Bath 1 Stale Data	Bath Input 1 is not reading valid data	6s
AL033	Bath 2 Sensor Open	Bath Input 2 sensor has an open circuit	6s
AL034	Bath 2 Sensor Short	Bath Input 2 in RTD Mode: Input is measuring a short circuit Bath Input 2 in Thermocouple Mode: This alarm cannot be set	6s
AL035	Bath 2 Out of Range	Bath Input 2 in RTD Mode: Input is outside valid RTD range Bath Input 2 in Thermocouple Mode: Input is outside valid Thermocouple range	6s
AL036	Bath 2 Stale Data	Bath Temperature Input 2 is not reading valid data	6s
AL037	Outlet High Temp ESD	Outlet Temperature Input is greater than High Temp ESD setpoint	2s
AL038	Outlet Temp Configuration Range Error	Outlet High Temp Setpoint is out of range OR Pilot Off Setpoint (if enabled) is greater than or equal to the High Temp Setpoint OR Main Off Setpoint (if enabled) is greater than or equal to the High Temp Setpoint OR Main Off Setpoint (if enabled) is greater than the Pilot Off setpoint (if enabled) OR Process Setpoint is greater than or equal to the High Temp Setpoint OR Process Setpoint is greater than the Pilot Off Setpoint (if enabled) OR Process Setpoint is greater than the Main Off Setpoint (if enabled) OR Low Temp Setpoint is greater than the Process Setpoint	0
AL039	Outlet Sensor Open	Outlet Input sensor has an open circuit	6s
AL040	Outlet Sensor Short	Outlet Input in RTD Mode: Input is measuring a short circuit Outlet Input in Thermocouple Mode: This alarm cannot be set	6s
AL041	Outlet Out of Range	Outlet Input in RTD Mode: Input is outside valid RTD range Outlet Input in Thermocouple Mode: Input is outside valid Thermocouple range	6s
AL042	Outlet Stale Data	Outlet Temperature Input is not reading valid data	6s
AL043	Stack High Temp ESD	Stack Temperature Input is greater than High Temp ESD setpoint	2s
AL044	Stack Temp Configuration Range Error	Stack High Temp Setpoint is out of range	0
AL045	Stack Sensor Open	Stack Input sensor has an open circuit	6s
AL046	Stack Sensor Short	Stack Input in RTD Mode: Input is measuring a short circuit Stack Input in Thermocouple Mode: This alarm cannot be set	6s
AL047	Stack Out of Range	Stack Input in RTD Mode: Input is outside valid RTD range Stack Input in Thermocouple Mode: Input is outside valid Thermocouple range	6s
AL048	Stack Stale Data	Stack Input is not reading valid data	6s
AL049	Aux High Temp ESD	Aux Temp Input is greater than High Temp ESD setpoint	2s
AL050	Aux Temp Out of Range	Aux Temp Input: Less than 3 mA OR greater than 21 mA	1s
AL051	Aux Temp Configuration Range Error	Pilot Off Setpoint (if enabled) is greater than or equal to the High Temp Setpoint OR Main Off Setpoint (if enabled) is greater than or equal to the High Temp Setpoint OR Main Off Setpoint (if enabled) is greater than the Pilot Off setpoint (if enabled) OR Process Setpoint is greater than or equal to the High Temp Setpoint OR Process Setpoint is greater than the Pilot Off Setpoint (if enabled) OR Process Setpoint is greater than the Main Off Setpoint (if enabled) OR Low Temp Setpoint is greater than the Process Setpoint	0
AL052	Ambient Temp Mismatch	Ambient Temperature Measurement mismatch between sensors ^[2]	6s
AL053	Ambient Temp 1 Invalid	Ambient Temperature sensor 1 on BMS card is reporting an invalid reading ^[2]	6s
AL054	Ambient Temp 2 Invalid	Ambient Temperature sensor 2 on BMS card is reporting an invalid reading ^[2]	6s
AL055	No Process Temp Configured	None of Bath, Outlet, or Aux temp are configured to be in Process Control mode	0
AL056	Pilot 1 Flame Fail	Pilot 1 has lost flame OR failed to ignite	0
AL057	Pilot 2 Flame Fail	Pilot 2 has lost flame OR failed to ignite	0

ID	Name	Alarm Condition	Set
AL058	Pilot 1 Flame Detected While Off	Flame has been detected on Pilot 1 input before Pilot ignition	0
AL059	Pilot 2 Flame Detected While Off	Flame has been detected on Pilot 2 input before Pilot ignition	0
AL060	Flame 1 Ion+ Wiring Fault	AC voltage on Pilot 1 input too low to reliably detect flame <i>Note: Usually caused by loading of the flame rod to ground</i>	3s
AL061	Flame 2 Ion+ Wiring Fault	AC voltage on Pilot 2 input too low to reliably detect flame <i>Note: Usually caused by loading of the flame rod to ground</i>	3s
AL062	Pilot ADC Start Fault	Internal BMS Card fault ^[2]	2s
AL063	Pilot ADC Read Fault	Internal BMS Card fault ^[2]	2s
AL064	Pilot ADC Stop Fault	Internal BMS Card fault ^[2]	2s
AL065	Flame 1 Voltage Fault	Pilot Flame 1 flame test failure ^[2]	3s
AL066	Flame 2 Voltage Fault	Pilot Flame 2 flame test failure ^[2]	3s
AL067	Low Voltage	In 12V Mode: System Voltage is less than 9.5V In 24V Mode: System Voltage is less than 19.0V	2s
AL068	High Voltage	In 12V Mode: System Voltage is greater than 16.8V In 24V Mode: System Voltage is greater than 33.6V	2s
AL069	System ADC Start Fault	Internal BMS Card fault ^[2]	2s
AL070	System ADC Read Fault	Internal BMS Card fault ^[2]	2s
AL071	System ADC Stop Fault	Internal BMS Card fault ^[2]	2s
AL072	Commissioning Setting is Set to Incomplete	The Commissioning Complete setting is set to Incomplete	0
AL073	Reserved		
AL074	Cross Compare Failure	Internal BMS Card fault ^[2]	2s
AL075	External Switch Stuck	External switch input is stuck in the Ignite position	5s
AL076	External Switch Invalid	External switch input is in an invalid position	0
AL077	User Stop via External Switch	External switch input is in the off position	0
AL078	User Stop via Interface	The BMS card received a stop command from the UI or remote Modbus device	0
AL079	Reserved		
AL080	Settings CRC Failed	Settings have been corrupted and cannot be verified	0
AL081	State Mismatch	Internal BMS Card fault ^[2]	1s
AL082	Pressure I2C Bus Fault	Internal BMS Card fault ^[2]	2s
AL083	High Pressure I2C Bus Fault	Internal BMS Card fault ^[2]	2s
AL084	Proof of Light Off I2C Bus Fault	Internal BMS Card fault ^[2]	2s
AL085	Level/Flow I2C Bus Fault	Internal BMS Card fault ^[2]	2s
AL086	Aux Temp I2C Bus Fault	Internal BMS Card fault ^[2]	2s
AL087	Aux In 1 I2C Bus Fault	Internal BMS Card fault ^[2]	2s
AL088	Aux In 2 I2C Bus Fault	Internal BMS Card fault ^[2]	2s
AL089	Pilot 1 I2C Bus Fault	Internal BMS Card fault ^[2]	2s
AL090	Pilot 2 I2C Bus Fault	Internal BMS Card fault ^[2]	2s
AL091	SSV1 I2C Bus Fault	Internal BMS Card fault ^[2]	2s
AL092	SSV2 I2C Bus Fault	Internal BMS Card fault ^[2]	2s
AL093	High Fire I2C Bus Fault	Internal BMS Card fault ^[2]	2s
AL094	System Voltage Current I2C Bus Fault	Internal BMS Card fault ^[2]	2s
AL095	IO Short Switch Run Fault	Internal BMS Card fault ^[2]	1.5s
AL096	IO Short Switch Ignition Fault	Internal BMS Card fault ^[2]	1.5s
AL097	IO Short Start Fault	Internal BMS Card fault ^[2]	1.5s
AL098	IO Short POC Fault	Internal BMS Card fault ^[2]	1.5s
AL099	IO Short UV Flame Off Fault	Internal BMS Card fault ^[2]	1.5s
AL100	IO Short UV Fault	Internal BMS Card fault ^[2]	1.5s
AL101	IO Short ESD Fault	Internal BMS Card fault ^[2]	1.5s
AL102	Reserved		
AL103	Reserved		
AL104	Reserved		
AL105	Flash Failed To Read	Internal BMS Card fault ^[2]	0
AL106	Flash Failed To Write	Internal BMS Card fault ^[2]	0
AL107	Descriptor Failure	Internal BMS Card fault ^[2]	0
AL108	Descriptor Mismatch	Internal BMS Card fault ^[2]	0

ID	Name	Alarm Condition	Set
AL109	Pilot 1 Valve Output Voltage Fault	Pilot 1 output is de-energized and voltage at BMS terminal 15 is greater than 5V	10s
AL110	Pilot 2 Valve Output Voltage Fault	Pilot 2 output is de-energized and voltage at BMS terminal 17 is greater than 5V	10s
AL111	SSV1 Output Voltage Fault	SSV 1 output is de-energized and voltage at BMS terminal 19 is greater than 5V	10s
AL112	SSV2 Output Voltage Fault	SSV 2 output is de-energized and voltage at BMS terminal 21 is greater than 5V	10s
AL113	Start Contact Out of Range	Input is not within a valid range ^[1]	2s
AL114	POC Contact Out of Range	Input is not within a valid range ^[1]	2s
AL115	ESD Contact Out of Range	Input is not within a valid range ^[1]	2s
AL116	UV Flame On Contact Out of Range	Input is not within a valid range ^[1]	2s
AL117	UV Flame Off Contact Out of Range	Input is not within a valid range ^[1]	2s
AL118	UV Flame Fault Contact Out of Range	Input is not within a valid range ^[1]	2s
AL119	Digital Input ADC Start Fault	Internal BMS Card fault ^[2]	2s
AL120	Digital Input ADC Read Fault	Internal BMS Card fault ^[2]	2s
AL121	Digital Input ADC Stop Fault	Internal BMS Card fault ^[2]	2s
AL122	Safety Output Mismatch	Internal BMS Card fault ^[2]	2s
AL123	Processor Reset	Internal BMS Card fault ^[2]	0
AL124	Calibration CRC Failed	Internal BMS Card fault ^[2]	0
AL125	Brownout Reset Voltage Incorrect	Internal BMS Card fault ^[2]	0
AL126	Flame 1 DC Input Open	Internal BMS Card fault ^[2]	3s
AL127	Flame 2 DC Input Open	Internal BMS Card fault ^[2]	3s
AL128	Factory Calibration Error	Internal BMS Card fault ^[2]	0
AL129	Process Setpoint Adjust Unit Configuration Error	Process Setpoint Adjust Input units are not set to a valid temperature unit	0
AL130	System Voltage Mismatch	Internal BMS Card fault ^[2]	10s
AL131	UV Flame Detect Mismatch	UV Flame Scanner Flame input and No Flame Input are both open or both closed	1s
AL132	UV Flame Detect Fault	UV Flame Scanner Fault input is open	1s
AL133	Pilot 2 Enabled with UV Pilot Detect	Pilot 2 is enabled when UV Flame Detect Mode is set to Pilot and Main	0
AL134	UV Flame Detected While Off	UV Detect Mode is Disabled: This alarm cannot be set UV Detect Mode is Main Only: UV Flame detected before Pilot Ignition or Main Light Off UV Detect Mode is Pilot and Main: UV Flame detected before Pilot Ignition	0
AL135	UV Flame Fail	Loss of UV flame	0
AL136	Interrupted Pilot Requires Main Flame Detection	Pilot Off Mode is Interrupted and UV Flame Detect Mode is disabled	0
AL137	Shutdown Failed To Set	Internal BMS Card fault ^[2]	0
AL138	Level/Flow Control Setpoint Configuration Error	Run Status Level/Flow Control setting is outside Level/Flow Low and High Trip setpoints	0
AL139	Pilot 2 Disabled While Min Pilots is 2	Minimum Pilots Running is 2 and Pilot 2 is disabled	0
AL140	Standby Setpoint Exceeds Process Setpoint	Bath Standby Mode enabled: Bath Standby Setpoint exceeds Bath Process Setpoint Bath Standby Mode disabled: This alarm cannot be set	0
AL141	Bath Standby Requires On/Off Control	Bath Standby Mode enabled: Process Control Mode is not set to On/Off Control Bath Standby Mode disabled: This alarm cannot be set	0
AL142	Bath Standby Requires Multiple Process Temps	Bath Standby Mode enabled: Outlet/Aux Temp not set up as a process control input Bath Standby Mode disabled: This alarm cannot be set	0
AL143	Pilot Off at Main Off and Bath Standby Enabled	Bath Standby Mode enabled: Pilot Off Mode is set to Off at Main Off Setpoint Bath Standby Mode disabled: This alarm cannot be set	0
AL144	UI Comm Loss	Comm Loss Alarm setting enabled: Communication loss between BMS and UI Cards Comm Loss Alarm setting disabled: This alarm cannot be set	10s
AL145	Appliance Firing Rate Aux Input Not Enabled	Process Control Mode is Firing Rate and Aux In 1/2 not set up as Firing Rate input	0
AL146	Invalid Aux Out Mode Selected	Configured Aux Output Mode is not supported	0
AL147	Reignition Configuration Error	Reignition enabled: Minimum Pilots Running is 2 OR Pilot 2 is disabled Reignition disabled: This alarm cannot be set	0
AL148	PID Configuration Error	Process Control Mode is set to PID control with a temperature input that is not set to process control	0
AL149	Level/Flow Control Requires 4-20 Input	Run Status Mode is Level/Flow Control: Level/Flow input type is disabled or digital Run Status Mode is not Level/Flow Control: This alarm cannot be set	0
AL150	Flame Detect Software Watchdog Trip	Internal BMS Card fault ^[2]	0

^[1] This fault can occur in one of two scenarios: a negative voltage is present on the Signal In terminal OR the BMS card has been compromised

^[2] This fault usually occurs when the BMS card has been compromised

10.2 WAITS

ID	Name	Wait Condition	Set
WT001	Low Voltage	In 12V Mode: Voltage Restart is enabled AND System Voltage is less than 9.5V In 24V Mode: Voltage Restart is enabled AND System Voltage is less than 19.0V	2s
WT002	High Voltage	In 12V Mode: Voltage Restart is enabled AND System Voltage is greater than 16.8V In 24V Mode: Voltage Restart is enabled AND System Voltage is greater than 33.6V	2s
WT003	Low Pressure ¹	Pressure Input in 4-20 mode: Input is less than Pressure Low Trip setting Pressure Input in Digital mode: Input is open	Low Pressure Delay setting
WT004	Low Level/Flow ¹	Level Input in 4-20 mode: Input is less than Level Low Trip setting Level Input in Digital mode: Input is open	Level/Flow Delay setting
WT005	High Level/Flow ¹	Level input in 4-20 mode: Input is greater than Level High Trip Level input in Digital mode: This wait cannot be set	Level/Flow Delay setting
WT006	High Bath Temp	Bath temperature is too high to require the system to be in a fuel state. Refer to Operating Sequence Section for configuration specific behavior	2s
WT007	High Outlet Temp	Outlet temperature is too high to require the system to be in a fuel state. Refer to Operating Sequence Section for configuration specific behavior	2s
WT008	High Aux Temp	Aux Temp temperature is too high to require the system to be in a fuel state. Refer to Operating Sequence Section for configuration specific behavior	2s
WT009	Start Contact Open	Start contact open	1s
WT010	Purging	System is Purging Note: The PoC input (if enabled) must be closed for the purge timer to count down	N/A
WT011	Aux In 1 Contact Open ¹	Aux In 1 input in 4-20 mode: This wait cannot be set Aux In 1 input in Digital mode: Input is open	2s
WT012	Aux In 1 Low Trip ¹	Aux In 1 Input in 4-20 mode: Input is less than Aux In 1 Low Trip setting Aux In 1 Input in Digital mode: This wait cannot be set	2s
WT013	Aux In 1 High Trip ¹	Aux In 1 Input in 4-20 mode: Input is greater than Aux In 1 High Trip setting Aux In 1 Input in Digital mode: This wait cannot be set	2s
WT014	Aux In 2 Contact Open ¹	Aux In 2 input in 4-20 mode: This wait cannot be set Aux In 2 input in Digital mode: Input is open	2s
WT015	Aux In 2 Low Trip ¹	Aux In 2 Input in 4-20 mode: Input is less than Aux In 2 Low Trip setting Aux In 2 Input in Digital mode: This wait cannot be set	2s
WT016	Aux In 2 High Trip ¹	Aux In 2 Input in 4-20 mode: Input is greater than Aux In 2 High Trip setting Aux In 2 Input in Digital mode: This wait cannot be set	2s

¹ Associated Trip Mode setting must be configured as a Wait

10.3 WARNINGS

ID	Name	Warning Condition	Set
WN001	Low Voltage	In 12V Mode: System Voltage is less than 10.2V In 24V Mode: System Voltage is less than 20.4V	2s
WN002	High Voltage	In 12V Mode: System Voltage is greater than 16.2V In 24V Mode: System Voltage is greater than 32.4V	2s
WN003	Low Level/Flow ¹	Level Input in 4-20 mode: Input is less than Level Low Trip setting Level Input in Digital mode: Input is open	Level/Flow Delay setting
WN004	High Level/Flow ¹	Level input in 4-20 mode: Input is greater than Level High Trip Level input in Digital mode: This warning cannot be set	Level/Flow Delay setting
WN005	Low Bath Temp	Bath Temperature reading is at or below the Bath Low Temp Setpoint	2s
WN006	Low Outlet Temp	Outlet Temperature reading is at or below the Outlet Low Temp Setpoint	2s
WN007	Low Aux Temp	Aux Temperature reading is at or below the Aux Temp Low Temp Setpoint	2s
WN008	High Pressure 4-20	Pressure in 4-20 mode: Input is greater than High Trip setpoint AND SSV outputs de-energized Pressure in Digital mode: This warning cannot be set	2s
WN009	Low Pressure ¹	Pressure Input in 4-20 mode: Input is less than Pressure Low Trip setting Pressure Input in Digital mode: Input is open	Low Pressure Delay setting
WN010	Aux In 1 Contact Open ¹	Aux In 1 input in 4-20 mode: This warning cannot be set Aux In 1 input in Digital mode: Input is open	2s
WN011	Aux In 1 Low Trip ¹	Aux In 1 Input in 4-20 mode: Input is less than Aux In 1 Low Trip setting Aux In 1 Input in Digital mode: This warning cannot be set	2s
WN012	Aux In 1 High Trip ¹	Aux In 1 Input in 4-20 mode: Input is greater than Aux In 1 High Trip setting Aux In 1 Input in Digital mode: This warning cannot be set	2s
WN013	Aux In 2 Contact Open ¹	Aux In 2 input in 4-20 mode: This warning cannot be set Aux In 2 input in Digital mode: Input is open	2s
WN014	Aux In 2 Low Trip ¹	Aux In 2 Input in 4-20 mode: Input is less than Aux In 2 Low Trip setting Aux In 2 Input in Digital mode: This warning cannot be set	2s
WN015	Aux In 2 High Trip ¹	Aux In 2 Input in 4-20 mode: Input is greater than Aux In 2 High Trip setting Aux In 2 Input in Digital mode: This warning cannot be set	2s
WN016	POC Contact Failed to Open	Proof of Closure Input enabled: Proof of Closure input closed AND SSV outputs are energized Proof of Closure Input disabled: This warning cannot be set	10s
WN017	Reserved		
WN018	Reserved		
WN019	UI to BMS Firmware Mismatch	UI and BMS firmware do not match	0
WN020	BMS Comm Loss	UI Comm Loss Alarm Setting is Enabled AND UI card has lost communications with the BMS card	0
WN021	Hardware Descriptor Error	Internal BMS Card fault	0
WN022	Product Variant Descriptor Error	Internal BMS Card fault	0
WN023	Firmware Descriptor Error	Internal BMS Card fault	0
WN024	Bootloader Descriptor Error	Internal BMS Card fault	0
WN025	UI Descriptor Error	Internal UI Card fault	0
WN026	Outlet Sensor Open	Outlet Mode is Display Only AND Outlet Input has a TC Open or RTD Open fault.	6s
WN027	Outlet Sensor Short	Outlet Mode is Display Only AND Outlet Input has an RTD short fault.	6s
WN028	Outlet Out of Range	Outlet Mode is Display Only AND Outlet Input is outside valid RTD or Thermocouple range	6s
WN029	Outlet Stale Data	Outlet Mode is Display Only AND Outlet Input is not reading valid data	6s
WN030	Stack Sensor Open	Stack Mode is Display Only AND Stack Input has a TC Open or RTD Open fault.	6s
WN031	Stack Sensor Short	Stack Mode is Display Only AND Stack Input has an RTD short fault.	6s
WN032	Stack Out of Range	Stack Mode is Display Only AND Stack Input is outside valid RTD or Thermocouple range	6s
WN033	Stack Stale Data	Stack Mode is Display Only AND Stack Input is not reading valid data	6s
WN034	Entered Bath Standby Mode	Bath Standby Mode is enabled AND a Process Control Temperature other than Bath has risen above its Process Setpoint	0
WN035	Pilot 1 Flame Lost	Minimum Pilots Running is 1: System running with Pilot 2 flame only and Pilot 1 output de-energized Minimum Pilots Running is 2: This warning cannot be set	0
WN036	Pilot 2 Flame Lost	Minimum Pilots Running is 1: System running with Pilot 1 flame only and Pilot 2 output de-energized Minimum Pilots Running is 2: This warning cannot be set	0
WN037	Aux Output 1 Fault	Aux Output 1 wiring problem or board fault	2s
WN038	Aux Output 2 Fault	Aux Output 2 wiring problem or board fault	2s
WN039	TCV Fault	TCV Output wiring problem or board fault	2s
WN040	TCV Manual Override Enabled	TCV Manual Override setting is enabled	0

¹ Associated Trip Mode setting must be configured as a Warning

10.4 MAIN PERMISSIVES

ID	Name	Main Permissive Condition	Set
MP001	Low Pressure ¹	Pressure Input in 4-20 mode: Input is less than Pressure Low Trip setting Pressure Input in Digital mode: Input is open	Low Pressure Delay setting
MP002	Aux In 1 Contact Open ¹	Aux In 1 input in 4-20 mode: This main permissive cannot be set Aux In 1 input in Digital mode: Input is open	2s
MP003	Aux In 1 Low Trip ¹	Aux In 1 Input in 4-20 mode: Input is less than Aux In 1 Low Trip setting Aux In 1 Input in Digital mode: This main permissive cannot be set	2s
MP004	Aux In 1 High Trip ¹	Aux In 1 Input in 4-20 mode: Input is greater than Aux In 1 High Trip setting Aux In 1 Input in Digital mode: This main permissive cannot be set	2s
MP005	Aux In 2 Contact Open ¹	Aux In 2 input in 4-20 mode: This main permissive cannot be set Aux In 2 input in Digital mode: Input is open	2s
MP006	Aux In 2 Low Trip ¹	Aux In 2 Input in 4-20 mode: Input is less than Aux In 2 Low Trip setting Aux In 2 Input in Digital mode: This main permissive cannot be set	2s
MP007	Aux In 2 High Trip ¹	Aux In 2 Input in 4-20 mode: Input is greater than Aux In 2 High Trip setting Aux In 2 Input in Digital mode: This main permissive cannot be set	2s

¹ Associated Trip Mode setting must be configured as a Main Permissive

11 GLOSSARY

Alarm	An indication of an abnormal condition in either the equipment or the process.	Non-volatile Lockout	Condition such that a restart can only be accomplished by a manual reset of the system and by no other cause
Continuous Pilot	A pilot which, once placed in operation, is intended to remain ignited continuously until it is manually interrupted	Permanent Operation	System which is intended to remain in the running position for longer than 24 h without interruption
Digital Input	An input to the system that can be one of only two states (Energized or De-energized).	Pilot-flame Establishing Period	Period of time between the signal to energize the pilot fuel flow means and the signal indicating presence of the pilot flame
Electronic Disconnection	Non-cycling interruption by an electronic device of a circuit for functional disconnection which provides a disconnection other than by means of an air gap by satisfying certain electrical requirements in at least one pole	Post-Ignition Time	Period of time between the signal indicating presence of flame and the signal to de-energize the ignition device
Flame Detector	Device which provides the programming unit with a signal indicating the presence of absence of flame	Post-Purge Time	Purge time that takes place immediately following the shutting off of the fuel supply
Flame Detector Response Time	Period of time between loss of the sensed flame and the signal indicating the absence of flame	Pre-Ignition Time	Period of the ignition time between the signal to ignite and the signal to energize the fuel flow means
Flame Detector Self-Checking Rate	Frequency of self-checking function of the flame detector (in number of operations per unit of time)	Pre-Purge Time	Purge time that takes place between initiation of a burner control sequence and the admission of fuel to the burner
Flame Failure Lock-out Time	Period of time between the signal indicating absence of flame and lock-out	Recycle Time	Period of time between the signal to de-energize the fuel flow means following the loss of flame and the signal to begin a new start-up procedure
Full Rate Start	Condition in which the main burner ignition and subsequent flame supervision occur at full fuel rate	Safety Output	A powered electrical output from the PF2200 BMS card designed to control safety actuators (e.g. safety shut off valves, ignition coils, etc.). Safety Outputs of the PF2200 BMS card are as follows: Pilot 1, Pilot 2, SSV, High Fire, Coil 1, and Coil 2.
Ignition Time	Period of time during which the ignition device is energized	Safety-interlock	A term used to describe an input (either switch or Transmitter) that must be satisfied to run. If the interlock is not satisfied (e.g. open switch or out of range transmitter) the system will proceed to lock-out.
Incorporated Control	Control intended for incorporation in, or on, an equipment, but which can be tested separately.	Shutdown	The process the system goes through when it receives an alarm event while running. This is immediately followed by entering the state of Lockout.
Intermittent Pilot	A pilot which is automatically ignited when an appliance is called on to operate and which remains continuously ignited during each period of main burner operation. The pilot is automatically extinguished when each main burner operating cycle is completed	Signal for Absence of Flame	Maximum signal which indicates the loss of flame
Interrupted Ignition	A type of ignition which is energized prior to the admission of fuel to the main burner and which is de-energized when the main flame is established	Signal for Presence of Flame	Minimum signal which indicates the presence of flame when there was previously no flame
Interrupted Pilot	A pilot which is automatically ignited prior to the admission of fuel to the main burner and which is automatically extinguished when the main flame is established	Start-up Lock-out Time	Period of time between the signal to energize the fuel flow means and lock-out
Lockout	A state in which all powered outputs (Valves and Ignition) are de-energized and interaction from the user is required in order to exit the state.	Type 2 Action	Automatic action for which the manufacturing deviation and the drift of its operating value, operating time, or operating sequence have been declared and tested per IEC 60730
Low Rate Start	Condition in which main burner ignition occurs at low fuel rate. Once ignition at low fuel rate occurs and the flame is proven, full main burner fuel rate may be admitted	Wait	An event which causes the BMS to proceed to a state which will de-energize all safety outputs. When all wait events clear, the BMS is free to automatically recycle.
Main Permissive	An event which causes the BMS to de-energize the main solenoid outputs (SSV) and remain in that state until the event clears (or an alarm / wait condition forces the BMS out)	Waiting Time	Period between the start signal and the signal to energize the ignition device. For burners without fans, natural ventilation of the combustion chamber and the flue passages normally takes place during this time.
Maximum Flame-failure Reignition Time	Period of time between the signal indicating absence of flame and the signal to energize the ignition device. During this time period the fuel supply is not shut off.		

12 ACRONYMS

1oo1	One out of One deployment	PWM	Pulse Width Modulation
BMS	Burner Management System	RTD	Resistive Thermal Device
ESD	Emergency Shut Down – a mechanism that shuts down the system in the event of a safety emergency	SIL	Safety Integrity Level. A discrete level (one out of a possible four) for specifying the safety integrity requirements of the safety functions to be allocated to the E/E/PE safety-related systems where Safety Integrity Level 4 has the highest level of safety integrity, and Safety Integrity Level 1 has the lowest
HEI	High Energy Ignition	SIF	Safety Instrumented Function. A set of equipment intended to reduce the risk due to a specific hazard (a safety loop)
HFT	Hardware Fault Tolerance	SFF	Safe Failure Fraction. The fraction of the overall failure rate of a device that results in either a safe fault or a diagnosed unsafe fault
HFV	High Fire Valve	SSV	Safety shutoff valve.
I/O	The generic name for a terminal that can be an input, output, or a combination of both.	TCV	Temperature Control Valve
PF2200-SB	The model number for the PF2200 Single Burner BMS product. Consists of: BMS Card, User Interface Card, keypad, and enclosure.		
PoC	Proof of Closure		
PFN	Profire Network. Method of communication between User Interface Card and BMS Card.		

13 DOCUMENT REVISION HISTORY

Document Version	Release Date	Applicable BMS Hardware	Applicable UI Hardware	Applicable Firmware
v10.0	10 FEB 2022	v2.3.x	v3.2.x	SB 2.2.0
v9.0	25 OCT 2021	v2.3.x	v3.2.x	SB 2.2.0
v8.0	24 SEP 2021	v2.3.x	v3.2.x	SB 2.2.0
v7.0	28 JAN 2021	v2.3.x	v3.2.x	SB 2.1.3
v6.0	30 SEP 2020	v2.3.x	v3.2.x	SB 2.0.4
v5.0	01 APR 2020	v2.3.0	v3.1.0	SB 1.2.3

13.1 CHANGE SUMMARY

13.1.1 VERSION 10.0

- Updated ratings table in section 2.2.1 to include power consumption information for the screen backlight
- Added sections 4.11.3 and 4.11.4 showing system behavior under various input voltage conditions
- Added recommended maintenance procedures in section 8.1

13.1.2 VERSION 9.0

- Added French safety warnings.

13.1.3 VERSION 8.0

- Added UL certification information on p.4
- Added settings modification helper graphics on p.11 and 12
- Added firmware update section to p.15
- Corrected Dual Rod Ignition Wiring diagram error on p. 67
- Updated Auxiliary Input Deadband setting limits on p.75

13.1.4 VERSION 7.0

- Corrected duplicated terminal numbers in Product Ratings section
- Updated External Ignition Switch behavior table
- Added AL150 Flame Detect Software Watchdog Trip alarm
- Updated alarm set times for AL060, 061, 065, 066, 126 and 127

13.1.5 VERSION 6.0

- Initial full release of Product Manual documenting all features and behavior.



UNITED STATES

1.801.796.5127
321 South, 1250 West Suite 1
Lindon, UT 84042, USA
support@profireenergy.com

CANADA

1.780.960.5278
9671 - 283 Street
Acheson, AB T7X 6J5, Canada
support@profireenergy.com